



2023

KATALOG | CATALOGUE

beleduc

PÄDAGOGISCHES
FACHWISSEN AUS FAST
60 JAHREN

*PEDAGOGICAL EXPERTISE
FOR ALMOST 60 YEARS*

INNOVATIONEN UND
SPIELKONZEPTE AM PULS
DER ZEIT

*INNOVATIONS AND
GAME CONCEPTS ON THE
PULSE OF TIME*

WIR SIND | WE ARE
beleduc

BESTE QUALITÄT FÜR
LANGEN SPIELEINSATZ

*BEST QUALITY
FOR LONG LASTING
PLAY*



EIGENE UND INNOVATIVE
PRODUKTENTWICKLUNG

*OWN AND INNOVATIVE
PRODUCT DEVELOPMENT*



NACHHALTIGE PRODUKTE
AUS NACHWACHSENDEN
ROHSTOFFEN

*SUSTAINABLE PRODUCTS
FROM SUSTAINABLE
RAW MATERIALS*

LERN- UND SPIELSPASS
OPTIMAL MITEINANDER
VERKNÜPFEN

*OPTIMALLY COMBINE
LEARNING AND
PLAYING FUN*

BESTER PARTNER FÜR DIE FÖRDERUNG FRÜHKINDLICHER BILDUNG – SPIELEN UND LERNEN MIT SPASS!

Wir freuen uns, dass Sie unseren neuen Katalog 2023 mit vielen innovativen, spannenden und neuen Produkte in der Hand halten. Entdecken Sie unsere Neuheiten in den verschiedenen Bildungsbereichen. Mit dem neuen **Nawito „Tierarten“** und **Humanico „Berufe“** haben wir unsere erfolgreichen Nawito und Humanico Puzzle-Serie erweitert.

Auch im Bereich der XXL Bodenpuzzles erwartet Sie ein neues **Puzzle „Blumenwiese“** bei dem es viel zu entdecken gibt.

Im Bereich Spiele gibt es auch einige spannende neue Produkte: Unser Bestseller **Punakai im XXL Format** mit unserer beliebten Spielmatte, **Quaki** – ein spannendes Spiel mit Magneten und **Happy & Harmony** – unser Zwergenspiel. Überzeugen Sie sich selbst von unseren neuen Lernspielen!

Auch der Bereich Rollenspiel, sowohl innen als auch außen kommt mit dem neuen **4 in 1 Haushalts-Center** und unserem **TopPlay Camping Car** nicht zu kurz. Unsere erfolgreiche TopTrike Linie wurde um zwei neue Fahrzeuge ergänzt – der **Maxi Roller** für die größeren Kinder und unser **Wheelie** für die Jüngeren.

Entdecken Sie unsere **neue Linie „Fröbel by beleduc“**. Lasst uns Fröbel spielen und neu entdecken! Die Spielgaben nach Friedrich Fröbel sind in unseren Fröbel Sets zu finden. Neu präsentiert – mit tollen Vorlagekarten und hilfreichen Teacher Guide zur Anwendung und Erklärung.

Unser Tipp: Schauen Sie auch auf unserer **neuen Webseite** vorbei! Hier finden Sie kostenlose **Zusatzmaterialien zum Download**, Videos und vieles mehr!

Unsere Arbeit beim Entwickeln von unseren Lernspielen ist von Begeisterung geprägt. Mit Herzblut, Ausdauer und viel Liebe zum Detail entwickeln wir unsere Produkte. Auf Seite 4 und 5 sehen Sie wie ein Produkt bei beleduc entsteht. Viele

große und kleine Schritte sind notwendig, sodass am Ende ein einzigartiges Produkt entsteht und im Markt eingeführt wird. Von der ersten Idee zum fertigen Produkt. Ein großes Danke an alle Mitwirkenden! Wir wünschen Ihnen viel Spaß mit unserem neuen Katalog und beim Entdecken unserer neuen Highlights!

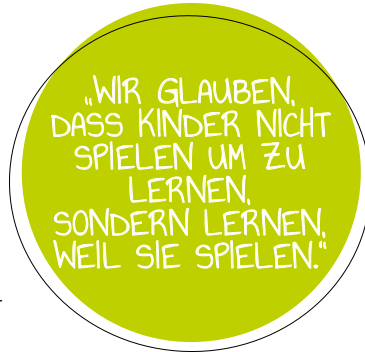

BEST PARTNER FOR PROMOTING EARLY CHILDHOOD EDUCATION – PLAYING AND LEARNING WITH FUN!

We are happy that you are holding in your hands our new catalogue for 2023 with many innovative, exciting and new products. Discover our novelties in our different educational areas! We have expanded our successful Nawito and Humanico puzzle series with the new **Nawito „Animal species“** and **Humanico „Professions“**. In our XXL floor puzzle range the new puzzle **„Discover the flower meadow“** awaits you to discover it.

In our game range there are also some new and exciting products like our bestseller **Punakai in XXL size** with our game mat, **Quaki** – an exciting game with magnets and **Happy & Harmony** – our gnomes game. Convince yourself of our new educational games!

Role play, both indoors and outdoors, does not left out with our new **Housekeeping Centre 4 in 1** and our **Top Play Camping Car**. Two new vehicles have also been added to our successful TopTrike line – the **Maxi scooter** for older children and our **Wheelie** for the younger ones.

Discover our **new line „Fröbel by beleduc“**. Let's play and discover Fröbel! The play gifts according to Friedrich Fröbel are in our Fröbel Sets. New presented – with great template cards and a helpful Teacher Guide for use and explanation.

Our tip: Take a look at our **new website!** There you will find a lot of **free additional materials to download**, videos and much more!

Our work in developing our educational products is characterised by passion. We develop our products with heart and soul, patience and a great love of detail.

On page 4 and 5 you can see how a product is created at beleduc. Many steps, big and small, are important to create a unique product at the end and to launch it on the market. From the first idea to the final product. Thank you very much to all participants! We hope you enjoy our new catalogue and discover our new highlights!



Es grüßt herzlichst | With best regards

Sabine Handstein
Sabine Handstein &
beleduc-Team

VON DER ERSTEN IDEE ZUM FERTIGEN PRODUKT

FROM THE FIRST IDEA TO THE FINAL PRODUCT

„Es sollte von allen Seiten bespielbar sein, einen hohen Aufforderungscharakter mit vielen Details und Funktionen zum Entdecken haben.“ – „Es muss robust sein.“ ... mit diesen Überlegungen beginnt der Prozess der Produktentwicklung bei beleduc. Schritt für Schritt zeigen wir Ihnen hier die Stationen während der Entstehung des neuen **mobilen Haushaltscenters 4 in 1** mit den verschiedensten Funktionen wie Kochen & Backen, Waschen, Bügeln und einem Hochstuhl für die Puppe.

“It should be playable from all sides, have a high challenging or stimulative character with lots of details and functions to discover.” – “It has to be sturdy.” ... with these ideas begins the process of product development at beleduc. Step by step, we show you here the stages during the creation of the new **mobile housekeeping centre 4 in 1** with various functions such as cooking & baking, washing, ironing and a “baby” feeding chair for the doll.

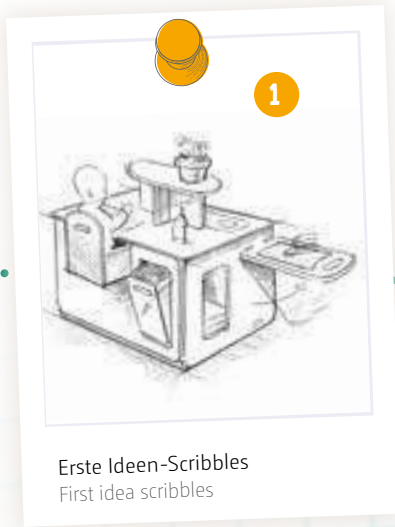

Neue Ansätze
am Puls der Zeit!
New concepts
on the pulse
of time!

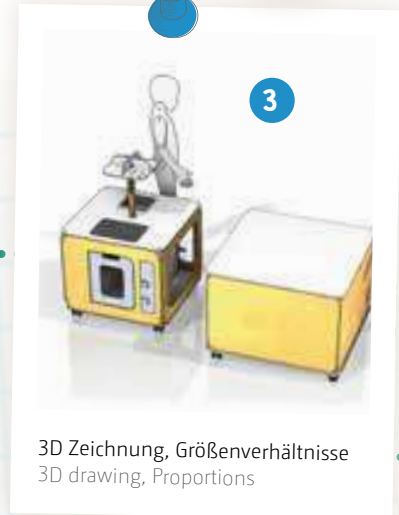

CHECKLISTE CHECKLIST

- Farb- und Materialauswahl
Choice of colour and materials
- Kostenkalkulation
Cost calculation
- Prototypbau
Prototype construction
- Testung im Kindergarten
Kindergarten testing



NEW
IDEA



Collorieren der
Scribbles
Colouring the
scribbles





Explosionszeichnung - Einzelteile / Verpackung
 Technical drawing - Individual parts / Packaging



Rezept- und WäscheTipps-Karten - weiteres Zubehör
 Recipe and laundry tips cards - more accessories



Zubehör - Accessories



Technische Zeichnung, Vermaßung
 Technical drawing, Dimension

Mobil durch Rollen
 Mobile by wheels

Finales Rendering - mit allen Details
 Final Rendering - with all details



Hinter den Kulissen beim Kindershooting
 Behind the scene at the kids shooting



Fertiges Produkt - Kinder- und Produktschooting - Marketingmaterial
 Final product - Kids- and Product shooting - Marketing material



MEHR ZU DIESEM PRODUKT
 S. 134/135
 MORE ABOUT THIS PRODUCT
 P. 134/135

„Ich finde es immer wieder spannend zu beobachten, wie Kinder im Rollenspiel alltägliche Situationen der Erwachsenenwelt nachspielen und hier gleichzeitig ihre eigenen Gefühle und Erlebnisse verarbeiten. Gerade das Spielen in der Gruppe schult das Sozialverhalten und die Fähigkeit zur Empathie. Es freut mich zu sehen, wenn eines unserer Produkte dazu beitragen kann, diese positiven Eigenschaften zu fördern.“

"I always think it is always exciting to observe how children act out everyday situations of the adult world in role play and at the same time deal with their own feelings and experiences. Playing in a group trains social behaviour and the ability to empathise. I am pleased to see when one of our products can help to promote these positive characteristics."



Ansgar Honkomp, Senior Designer beleduc



AUSZEICHNUNGEN • AWARDS

UNSERE ARBEIT WIRD NICHT NUR DURCH DAS LÄCHELN DER KINDER BELOHNT.

OUR WORK IS NOT ONLY REWARDED BY THE CHILD'S SMILE.



Deutschland
Germany



Deutschland
Germany



Deutschland
Germany



Deutschland
Germany



Deutschland
Germany



Belgien
Belgium



Deutschland
Germany



Österreich
Austria



Indien
India



USA



Großbritannien
Great Britain

- * Mit dem **spiel-gut Siegel** werden Spielsachen ausgezeichnet, die folgende Kriterien erfüllen:
- Fördert die Fantasie der Kinder, anstatt sie einzuschränken.
 - Hoher Aufforderungscharakter, Produkt bleibt interessant.
 - Ist sicher, d. h. weist eine gute Qualität auf, ist altersgerecht und erfüllt aktuelle Sicherheitsnormen.

- * The **spiel-gut Award** is given to toys which fulfil the following criteria:
- Stimulates children's fantasy instead of limiting it.
 - Highly animating products which stay interesting.
 - Item is safe, which means the item is high-quality, age-appropriate and is compliant with all safety standards.













SPLASH landet beim BDKJ Kinderspietest auf dem **1. PLATZ!**

SPLASH gets the **1ST PLACE** in the children's game test!

SIEHE S. 77
SEE P. 77



INHALT • CONTENT

	FÖRDERNAVIGATOR DEVELOPMENT NAVIGATOR	9
	SMALL KIDS	16
	PUZZLES	22
	SPIELE GAMES	58
	BAUEN & EXPERIMENTIEREN BUILDING & EXPERIMENTING	100
	POLY-M	116
	WAND- & RAUMELEMENTE WALL- & ROOM ELEMENTS	124
	ROLLENSPIEL ROLEPLAY	128
	SAND & BEWEGUNG SAND & MOVEMENT	148
	TOPTRIKE Fahrzeuge TOPTRIKE Vehicles	164
	TOPPLAY Rollenspiel im Außenbereich TOPPLAY Roleplay Outdoor	192
	KREATIV UND GESCHENKE CREATIVE WORLDS & GIFTS	216
	INDEX • POS • ERSATZTEILE INDEX • POS • SPARE PARTS	230

FÖRDER • DEVELOPMENT NAVIGATOR

JETZT NEU
Unser Bildungs-
bereich Flyer

NEW
Our education
area flyer

www.beleduc.de





WAS UNS BESONDERS AUSZEICHNET

WHAT WE STAND FOR

Pädagogisches Fachwissen aus fast 60 Jahren Erfahrung
Pedagogical expertise for almost 60 years

Besonderes Lernspiel-Angebot entwickelt für die früh-kindliche Bildung von Kindern im Alter von 1–7 Jahren
Unique learning material developed for early childhood education for kids at the age of 1–7 years

Kindgerechte Förderung mit hohem Spaßfaktor beim Lernen
Child-friendly development with a high learning fun factor

Hochwertige und robuste Qualität für langen Spieleinsatz
Sturdy and high-quality products offer long term gaming fun

Nachhaltige Produkte aus nachwachsenden Rohstoffen
Sustainable toys made from renewable resources

Familienunternehmen mit sozialer Verantwortung
Family owned business with social responsibility

Internationales Bildungsnetzwerk aus Praxis & Wissenschaft
International education network with pedagogues & science

BILDUNGSBEREICHE • EDUCATIONAL AREAS

All unsere Produkte sind Bildungsbereichen zugeordnet, die in der folgenden Übersicht erläutert werden – nach dem Ansatz der ganzheitlichen Bildung. | All our products are classified in educational areas, which are represented in the following overview – following the holistic education approach.

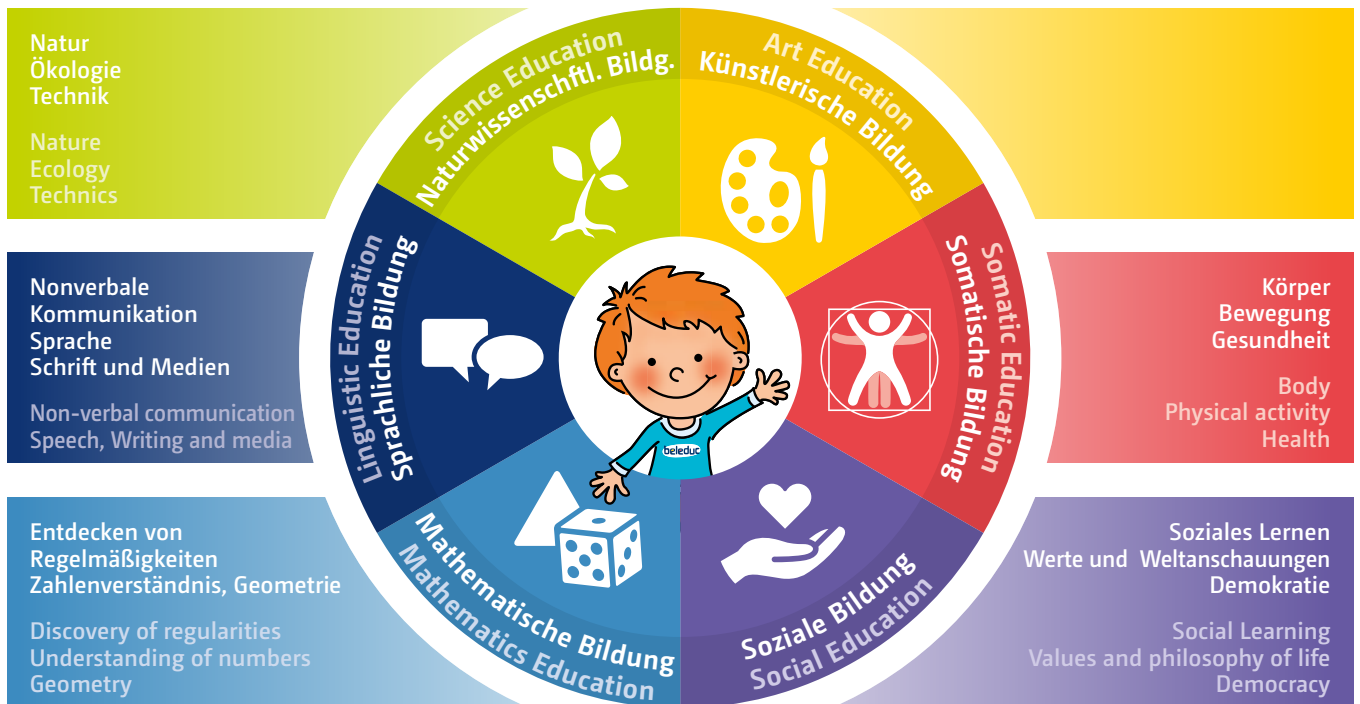

ICONS BILDUNGSBEREICHE | EDUCATIONAL AREAS





Produkt · Product

Artikelnummer
Item number

Alter · Age
-3 +3

Spieleranzahl
Number of players

Seitenzahl · Page

Bildungsbereiche
Areas of Education



Künstlerische Bildung · Art Education

Betty Fly	22463		•	2-4	65	•	•	•						
Candy	22461		•	1-8	87	•	•	•						
Creative Worlds			•	1+	216-229	•								
DIY Kratzposter XL · DIY Scratch Poster XL	53051		•		226	•								
Fairy Land	22611		•	2-4	83	•				•				•
Flexistix XXL – Kindergartenset	24200		•	1+	111	•				•				•
Flying Colours	68500		•	1+	115	•	•	•						
Goldener Apfel · Golden Apple	22370		•	2-4	91	•	•	•						
Hexenküche · Happy Magic	22700/22701		•	2-4	85	•	•	•						
Klangkoffer „Let’s Play“ · Melody Box “Let’s play“	21024		•	1+	107	•	•			•				
LogiPic	21020		•	1+	94	•	•						•	
Poly-M – Basic Bausteine · Basic Building Bricks		•		1+	118-119	•	•	•	•	•	•			•
Poly-M Construction Plates	20910		•	1+	122	•	•	•	•	•	•			•
Poly-M – Kreative Bausteine · Creative Building Bricks			•	1+	120-121	•	•	•	•	•	•			•
Punakai	22860		•	2-4	78	•	•	•						
Quadrilla XXL – Kindergartenset	24210		•	1+	110	•	•			•				
Rasselbande · Sound Box	23607		•	1+	113	•				•			•	
XXL Candy	25560		•	1-8	99	•	•	•						
XXL Eisenbahn Set · Railway Set NEW!	24201		•	1+	109	•	•	•						
XXL Fantasy Puzzle Insekten/insects	11013		•	1+	52	•				•				•
XXL Hexenküche · XXL Witches’ Kitchen	25520		•	2-4	99	•	•	•						
XXL Punakai NEW!	25583		•	2-4	97	•	•	•						
XXL Puzzle Wild Animals NEW!	11014		•	1+	51	•						•		•

Somatische Bildung · Somatic Education

Balance Board	67130		•	1+	151		•						•	
Bewegungsspielzeug · Physical Activity Toys		•	•	1+	150-155		•	•	•	•				
Block Puzzle	11300	•		1+	53		•					•		•
Cassado	25540		•	2-4	98		•	•	•					
Climb	25582		•	2-6	74	•	•	•						
El Gecko	22900		•	1-6	81	•	•			•				
Fishing Fever	22360		•	1-4	88		•	•	•					
Flexipainter	21120		•	1+	92	•	•					•		
Flooping	22830		•	2	81		•				•	•		
Gewichtebox · Weight Box	23608		•	1+	113		•				•	•		
Lagenpuzzle „kleiner Schmetterling“ - layer puzzle “little butterfly“	10139	•		1+	25	•	•			•				
Lagenpuzzle „kleiner Marienkäfer“ - layer puzzle “little ladybird“	10140	•		1+	25	•	•			•				
Magnetic Drawing Boards	21040		•	1+	93	•	•				•			



Somatische Bildung · Somatic Education

Magnetic Game Bright Colours „Kunterbunt“	21050	•	1+	92	•	•	•	•	•
Maxi Roller NEW!	64390	•	1	187	•	•	•	•	•
Mobile Tank- und Servicestation · Mobile Gas and Service Station“	62060	•	1+	190 + 201	•	•	•	•	•
Multi-Bänke – Multi Benches	68320	•	1+	212	•	•	•	•	•
Outdoor: Fahrzeuge und Zubehör · Vehicles and Equipment		•	1+	173-191	•	•	•	•	•
Outdoor: Sandspielzeug · Sand Toys		•	1+	156-163	•	•	•	•	•
Quaki	22619	•	2-4	61	•	•	•	•	•
Rondo Vario	22481	•	1-4	87	•	•	•	•	•
Splash	22615	•		77	•	•	•	•	•
Tandem-Tafeln · Tandem Boards	23614	•	1+	113	•	•	•	•	•
Tastaro	22396	•	1-5	98	•	•	•	•	•
TopTrike Fahrzeuge · Vehicles		•	1+	170-189	•	•	•	•	•
Wandelement „Berge“ · Wall Element “Mountains”	23623	•	1+	126	•	•	•	•	•
Wandelement „Labyrinth“ · Wall Element “Labyrinth”	23610	•	1+	126	•	•	•	•	•
Wandelement „Schmetterling“ · Wall Element “Butterfly”	23621	•	1+	126	•	•	•	•	•
Wandelement „Welle“ · Wall Element “Wave”	23622	•	1+	126	•	•	•	•	•
Wandspielobjekt „Raupe“ · Wall Toy “Caterpillar”	23630-23634	•	1+	125	•	•	•	•	•
Wheelie NEW!	64115	•	1	176	•	•	•	•	•
Wobbling City	25581	•	1+	75	•	•	•	•	•
XXL Fishing Fever	25510	•	1-4	99	•	•	•	•	•
XXL Rondo Vario	25550	•	1-4	99	•	•	•	•	•

Soziale Bildung · Social Education

Buggy Indoor	24401	•	1+	147	•	•	•	•	•
Buggy Outdoor	64350	•	1+	174, 210	•	•	•	•	•
Camping Car NEW!	62050	•	1+	199	•	•	•	•	•
Doctor Station 3 in 1	24232	•	1+	137	•	•	•	•	•
Fire Alarm	22890	•	2-4	76	•	•	•	•	•
Handpuppen „Tiere“ · Handpuppets “Animals”		•	1+	139-142	•	•	•	•	•
Happy Farm	22710	•	2-4	85	•	•	•	•	•
Humanico „Emotionen“ · Humanico “Emotions”	11555	•	1+	38	•	•	•	•	•
Humanico „5 Sinne“ · Humanico “5 senses”	11556	•	1+	39	•	•	•	•	•
Kiosk 4 in 1	62040	•	1+	197	•	•	•	•	•
Haushalts-Center 4 in 1 · Housekeeping center 4 in 1 NEW!	24236	•	1+	135	•	•	•	•	•
XL Küchen-Set · XL Kitchen Set	24234	•	1+	202	•	•	•	•	•
Magnetic Game »Kinder & Tiere der Welt« »Kids & Animals of the World«	11190	•		54	•	•	•	•	•
Oops!	23654	•	2-4	98	•	•	•	•	•
Outdoor: Verkehrssicherheit · Road Safety	68170+68190	•	1+	191	•	•	•	•	•



Produkt · Product

Artikelnummer
Item number

Alter · Age
-3 +3

Spieleranzahl
Number of players

Seitenzahl · Page

Bildungsbereiche
Areas of Education



Soziale Bildung · Social Education

„Puppetshow“	40318	•	1+	146	•	•	•	•	•
XL Aktionstheater · XL Action theatre	24231	•	1+	144	•	•	•	•	•
XXL City-Parkhaus · XXL City-Parkhouse	24230	•	1+	133	•	•	•	•	•
XXL Lernpuzzle „Entdecke die Welt“ XXL Learning-Puzzle “Discover the world”	11200	•	1+	55	•	•	•	•	•
XXL Puppenhaus · XXL Dollhouse – Kindergarten-Set NEW!	24235	•	1+	131	•	•	•	•	•

Mathematische Bildung · Mathematics Education

Acrobatico	22870	•	2-4	80	•	•	•	•	•
Catch The Number	22800	•	2-4	79	•	•	•	•	•
Cognito	11530-11550	•	1+	32-33	•	•	•	•	•
Cookie Doo	22614	•	2-4	64	•	•	•	•	•
DOMInext	22617	•	2-4	69	•	•	•	•	•
Find Monty!	22411	•	2-5	90	•	•	•	•	•
Fröbel by beleduc NEW!	24300+24301	•	1+	102-105	•	•	•	•	•
Fun Park	22612	•	2-4	82	•	•	•	•	•
Happy & Harmony NEW!	22620	•	2	63	•	•	•	•	•
Joe’s Zoo	22618	•	1+	71	•	•	•	•	•
Legepuzzles · Matching puzzles	11008+11009	•	1+	26	•	•	•	•	•
Legolino	22571	•	1+	86	•	•	•	•	•
Little Village	22600	•	2-4	84	•	•	•	•	•
LogiPlay	21070	•	1+	94	•	•	•	•	•
Logiturn	21021	•	1+	95	•	•	•	•	•
Marbelino 1 „Sorting“	21022	•	1-4	72	•	•	•	•	•
Marbelino 2 „Pattern“	21023	•	2-4	73	•	•	•	•	•
Martello	22380	•	1+	88	•	•	•	•	•
Mecki & Co.	22355	•	2-4	91	•	•	•	•	•
MEMOnext	22616	•	2-4	68	•	•	•	•	•
Mia’s Garden	22613	•	2-4	80	•	•	•	•	•
Monkey Rallye	22400	•	2-4	84	•	•	•	•	•
Shapy	22471	•	1-8	89	•	•	•	•	•
TanGeo	24040	•	1+	114	•	•	•	•	•
Tempo Toni	22790	•	2-4	86	•	•	•	•	•
Mobile Waage · Mobile Scale	64370	•	1+	203	•	•	•	•	•
Torreta	22451	•	2-4	89	•	•	•	•	•
Tropicano	22510	•	2-4	90	•	•	•	•	•
Wandelement „Steckformen“ · Wall Element “Shapes”	23612	•	1+	126	•	•	•	•	•
XXL Torreta	25512	•	2-4	99	•	•	•	•	•



Sprachliche Bildung · Linguistic Education

Banditti	22390	•	2-4	79			•	•	•	
Doktor-Set · Doctor on call	24232	•	1+	138			•	•		•
Geschichten-Handpuppen · Story Handpuppets	40411, 40421, 40431	•	1+	145			•	•		•
Humanico „Berufe“ · Humanico “Professions” NEW!	11557	•	1+	37			•	•		•
Marionette „Tukan Toni“ · String puppet “Tucan Toni”	42060	•	1+	146			•	•		•
Match & Mix	11006, 11007	•		24			•			•
Match & Mix Fantasy, Kinder · kids, Animal Kingdom	11130, 11150, 11160	•	1+	40			•	•		•
Match & Mix „Monster“	11180	•		41			•		•	•
Mutter-Kind-Handpuppen · Mom & Baby Handpuppets	40440-40460	•	1+	143			•	•		•
Rahmenpuzzles · Frame Puzzles	12000, 12001, 12002, 12010	•	1+	27			•			•
Read My Mind	22470	•	2-6	98	•		•			•
Sortierpuzzles für die Kleinsten · Sorting Sets for the Youngest	11030,11040, 11050	•	1+	24			•	•		•
ToPoLoGo „Visio“	21006	•	1+	114	•				•	•

Naturwissenschaftliche Bildung · Science Education

Bodenpuzzle „Entdecke den Wald“ · Floor Puzzle “Discover the forest”	16210	•	1+	30			•	•		
Bodenpuzzle „Entdecke die Blumenwiese” NEW! Floor Puzzle “Discover the flower meadow”	16212	•	1+	29			•			•
Bodenpuzzle „Tiefsee bis Weltall“ · Floor Puzzle “Deep sea to cosmos”	16211	•	1+	31			•			•
Junior Inventor - XXL Kindergartenset	24220	•	1+	112	•					•
Lagen-Puzzles „Entwicklung” Obst/Gemüse Layer-Puzzles “Development” Fruits/Vegetables	17039, 17040 17043, 17044, 17049	•	1+	44-45			•			•
Lagen-Puzzles „Entwicklung” Körper Layer-Puzzles “Development” Body	17024, 17052, 17058, 17160, 17170	•	1+	42-43			•			•
Lagen-Puzzles „Entwicklung” Tiere Layer-Puzzles “Development” Animals	17053-17055	•	1+	46			•			•
Lagen-Puzzle „Zuhause“ · Layer-Puzzle “Home”	17061	•	1+	48			•			•
Mobiles Gewächshaus · Mobile Greenhouse	62010	•	2-4	209			•			•
Mobile Küche · Mobile Kitchen	62030	•	2-4	205			•			•
Mobiler Wasser-Tisch · Mobile Water-Table	62020	•	2-4	207			•			•
Oscar	42045	•	1+	147			•	•		•
Puzzle „NAWITO” „Tierarten“ · “Animal Species” NEW!	11582	•	1+	34			•			•
Puzzle „NAWITO”	11560, 11570, 11580, 11581	•	1+	35-36			•			•



BELEDUC: SMALL KIDS

All unsere Produkte sind Förderbereichen zugeordnet, die in der folgenden Übersicht erläutert sind.
All our products are classified in basic skills, which are represented in the following overview.

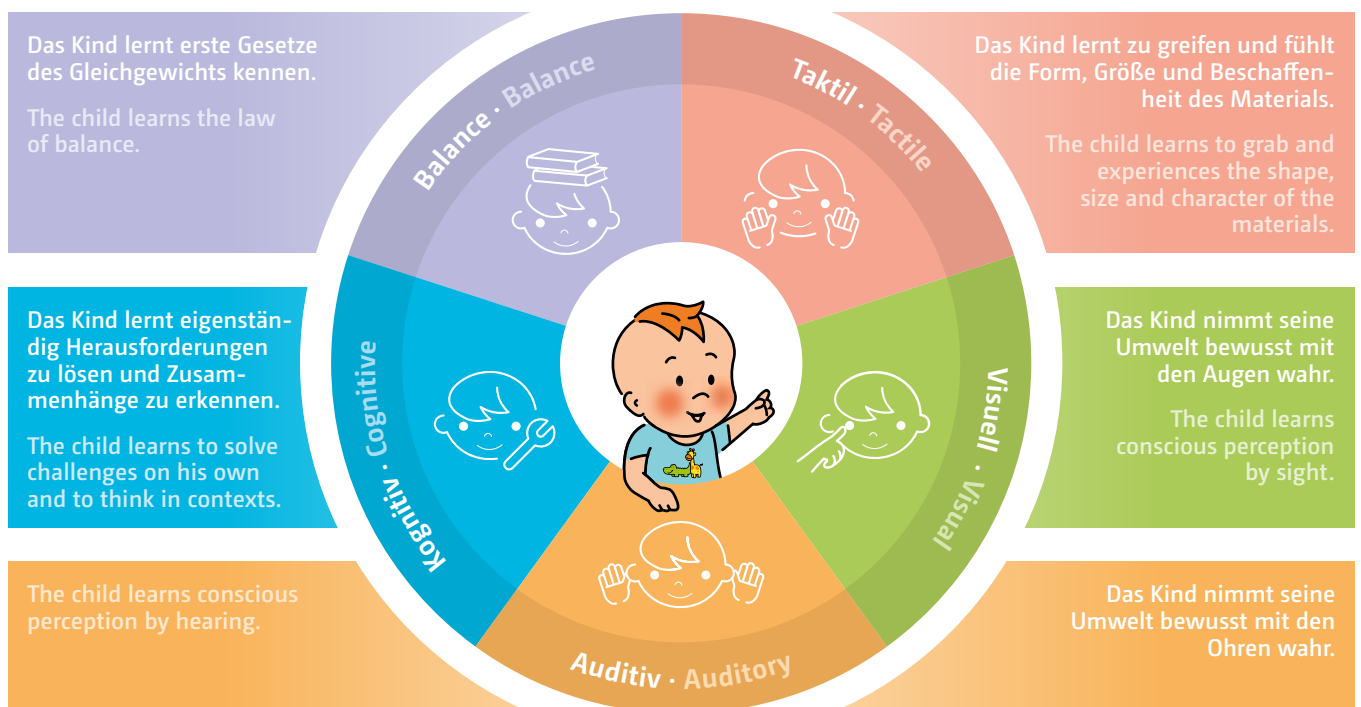

ICONS SMALL KIDS

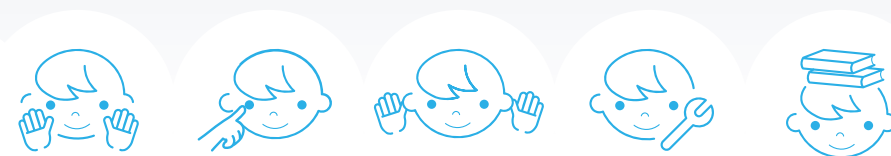



12M+

Triple Stacker	18001		18		•	•		•
Funny Four	18004		18		•	•		•

18M+

Animal Puzzle	18008		19		•	•		•
---------------	-------	--	----	--	---	---	--	---

24M+

Stacky Tower	18015		19		•	•		•
Wild Climber	18021	1+	20	•	•	•		•

UNSER EXPERTE · OUR EXPERT

Prof. Dr. Hartmut Wedekind, Professur für Frühpädagogik und -didaktik mit den Schwerpunkten Naturwissenschaften, Mathematik und Technik, Alice Salomon Hochschule Berlin (FH)

Prof. Dr. Hartmut Wedekind, Professorship for Early Childhood Education and Didactics with a focus on Science, Mathematics and Technics at the Alice Salomon University of Applied Sciences Berlin



„Insbesondere in den ersten Lebensjahren ist das Spiel die nahezu einzige Tätigkeit des Kindes. Spielpädagogen haben ausgerechnet, dass Kinder bis zum vollendeten 6. Lebensjahr ca. 15.000 Stunden spielen. Das sind 7 bis 8 Stunden am Tag. Umso bedeutender ist es, dass Kinder in einer anregungsreichen, sozial sicheren und ästhetisch anspruchsvollen Umgebung sich ihrem Spiel hingeben können und dafür geeignete Materialien finden, mit denen sie in sehr variantenreicher Art und Weise sich die Welt der Dinge, Sachverhalte und Phänomene erschließen.“

"Especially during the first years playing is almost the single activity a child does. Pedagogues have calculated that a child plays 15,000 hours until the age of 6. That means 7-8 hours a day. Therefore, it is even more important, that children play in an engaging, socially secure and aesthetic environment and find useful materials, in which they explore the world of objects, causes and phenomena."



SMALL KIDS

Spielerisch die Welt entdecken.
Exploring the world playfully.





Triple Stacker | Dieses Produkt
finden Sie auf Seite 18
Triple Stacker | You can find
this product on page 18



18001

TRIPLE STACKER

Blöcke stapeln macht Spaß! Drei farbenfrohe Form-Sets sind auf Holzstäbe zu stapeln. Mit dem Triple Stacker kann das Kind das Greifen und Stapeln von Blöcken erlernen. So wird die Feinmotorik und die Auge-Hand-Koordination geschult. Die großen Blöcke eignen sich hierbei perfekt für die kleine Kinderhand.

Stacking blocks is fun! Three colourful shapes are stacked and built on three poles. With the Triple Stacker the baby can practise holding blocks and stacking them. This promotes fine motor skills and hand-eye coordination. The big wooden blocks facilitate grasping.

Boxgröße | Box size: 180 x 210 x 105 mm



ALLE TEILE AUS HOLZ
ALL PARTS MADE OF WOOD

GRUNDFORMEN HAPTISCH
VERSTEHEN LERNEN
UNDERSTANDING THE BASIC
SHAPES HAPTICALLY



Vieleck
Polygon

Quadrat
Square

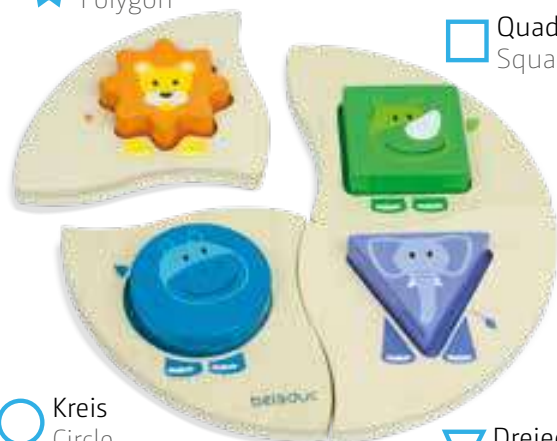

Kreis
Circle

Dreieck
Triangle



18004

FUNNY FOUR

Welche Form hat das Nilpferd? Welche hat der Löwe? Das Unterscheiden von Formen ist Grundlage für ein erstes Verstehen der Umwelt. Das Einpassen der Formen in ihre Aussparungen macht dies haptisch erlebbar.

What is the shape of the hippo? What is the shape of the lion? It is essential for children to learn the differences of the basic shapes. The Funny Four teach this haptically.

Boxgröße | Box size: 220 x 220 x 60 mm





18015

STACKY TOWER

Puzzle mal anders! Beim Stacky Tower üben die Kleinsten nicht nur Formen zu sortieren, sondern auch noch Farben zu erkennen und so einen dreidimensionalen Turm aufzubauen. Die freundlichen Dschungeltiere sind durch ihre Farbgebung dabei eine große Hilfe.

Solving puzzles differently! With the Stacky Tower children can not only sort, but also recognize shapes and build up a three dimensional tower. The friendly safari animals are a great help because of their colouring.

Boxgröße | Box size: 280 x 200 x 80 mm



18008

ANIMAL PUZZLE

Puzzle dein Tier! Das Animal Puzzle fördert erstes Puzzeln und das Bauen mit Klötzen. Beim freien Stapeln kreieren die Kinder Fantasietiere und trainieren ihre Feinmotorik. Im zweiten Schritt kann dann das korrekte Tier gestapelt werden. Das Kind lernt Zusammenhänge und Relationen wie lang-kurz und groß-klein kennen. Die Holzklötze sind kindgerecht illustriert und bereiten viel Spielfreude!

Puzzle your animal! The Animal Puzzle provides first experiences of solving puzzles and building with blocks. The children can create fantasy animals and practise their fine motor skills by stacking the animal parts freely. The second step is building the animal correctly, so children learn about concepts and associations like long-short and big-small. The wooden blocks are child-friendly illustrated and are fun to play with.

Boxgröße | Box size: 245 x 160 x 50 mm





18021

WILD CLIMBER

Ein Elefant, der ganz viel kann! Auf dem Rücken des Wild Climbers und seiner Freunde können kleine Abenteurer eine Menge Spaß haben! Rutschen, Klettern und Schaukeln sind nur einige der Möglichkeiten. Dabei kann der Wild Climber immer wieder anders und neu zusammen gesetzt werden und sorgt so für grenzenlosen Spielspaß. Der Wild Climber fördert die somatischen Fähigkeiten der Kinder umfassend und ermutigt durch seine Gestaltung zur Bewegung.

An elephant with a lot of skill! Little adventurers can have lots of fun on the back of the Wild Climber and his friends! Sliding, climbing and swinging are only some exercises children can practise with the Wild Climber. At the same time the Wild Climber can always be arranged in new and different ways and therefore provides limitless playing fun. The Wild Climber fosters the somatic skills of children widely and its design encourages exercise.

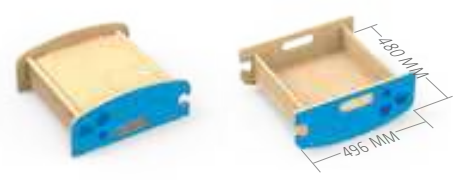
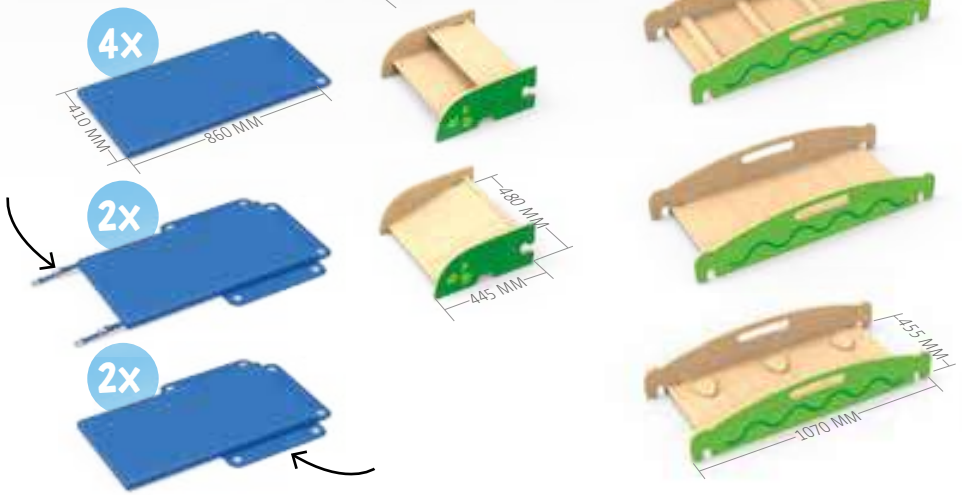

INKL. 8 BODENMATTEN MIT UNTERSCHIEDLICHEN BEFESTIGUNGEN
INCL. 8 FLOOR MATS WITH DIFFERENT FASTENINGS
FLEXIBLES SYSTEM
FLEXIBLE SYSTEM

WILD CLIMBER



16 tlg. Bewegungslandschaft für grenzenlosen Spielspaß!
Exercise landscape with 16 pcs. for limitless play fun!

TIPP!

VIelfältige Aufbauvarianten
VARIOUS SETUP VARIATIONS

**TOLLES DESIGN MIT HOHEM
AUFFORDERUNGSSCHARAKTER**
GREAT DESIGN IS HIGHLY
ENCOURAGING

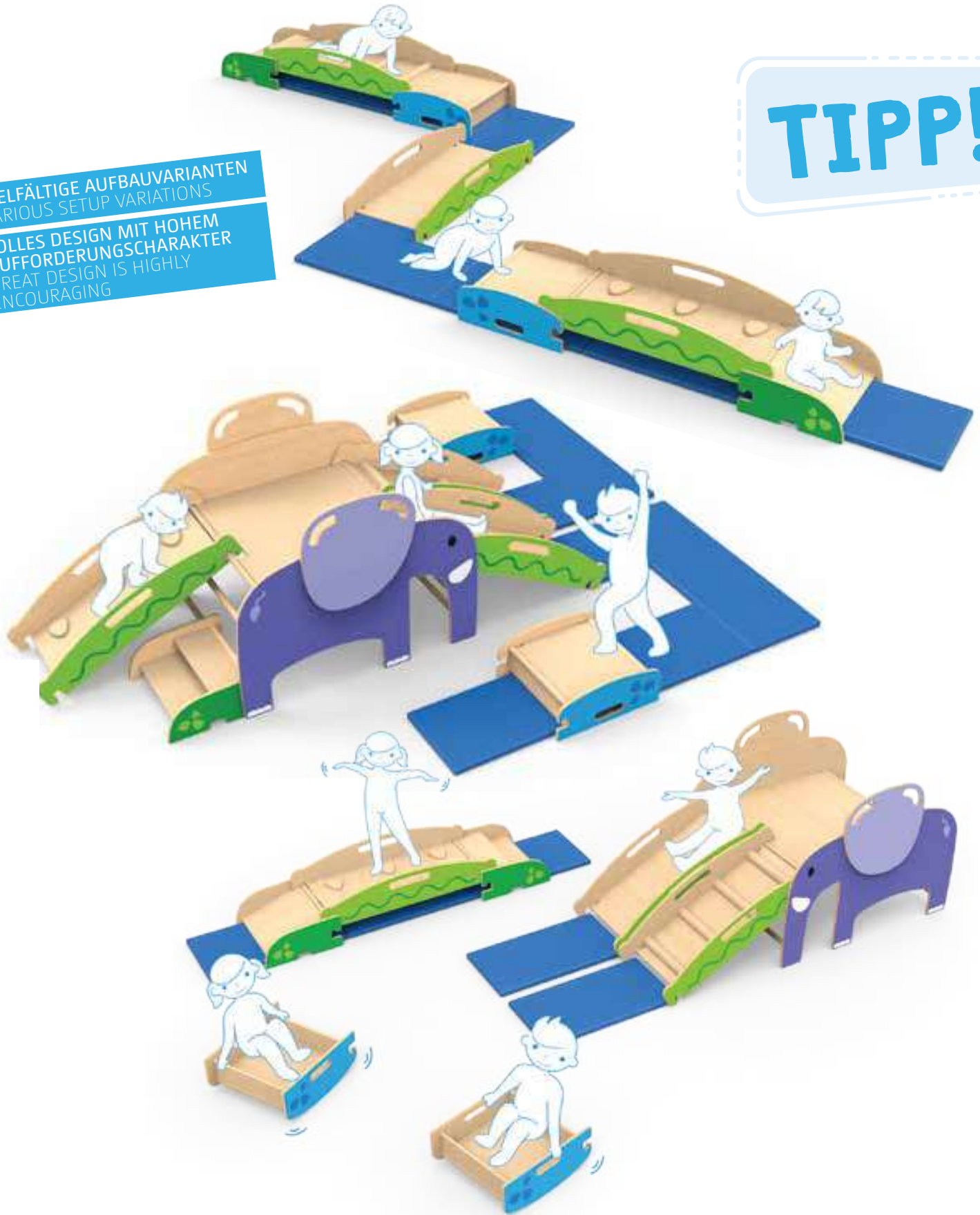

Taktil
Tactile



Visuell
Visual



Auditiv
Auditory



Kognitiv
Cognitive



Balance
Balance



PUZZLES

Taucht ein in die spannende Welt der Puzzles!
Dive into the fascinating world of puzzles!





NEW!

XXL Wild Animals Puzzle |
Diese Neuheit finden Sie auf Seite 50–51
XXL Wild Animals Puzzle |
You can find this novelty on page 50–51



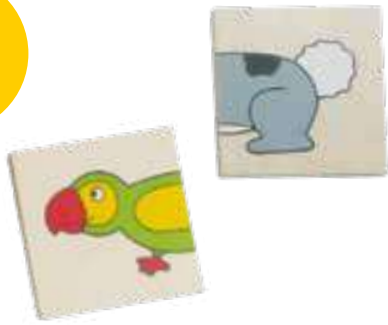

LEGE DEINE FANTASITIERE!
CREATE YOUR FANTASY ANIMALS!

LEGE DEINE FANTASIEFAHRZEUGE!
CREATE YOUR FANTASY CARS!



11006 · ANIMALS

11007 · TRANSPORT



MATCH & MIX

Unsere beiden Puzzles für die Kleinsten bieten mehrere Spielmöglichkeiten. Man kann die Teile passend zusammenpuzzeln, Fantastiere oder -fahrzeuge erfinden oder ein einfaches Memo spielen, indem man die passenden Vorder- oder Hinterteile findet.

These two puzzles for the youngest children offer various options of playing. You can match the pieces to a complete puzzle, create your own fantasy animals or cars or just play a simple memo game, by finding the correct front and back parts.

Puzzelgröße | Puzzle size: 336 × 289 × 9 mm



AUCH ALS
LOTTO SPIELBAR!
CAN BE PLAYED AS
A LOTTO GAME!



SORTIERPUZZLES FÜR DIE KLEINSTEN

Die Elemente auf den Holzkarten finden sich in den verschiedenen Szenen auf dem Puzzlebrett wieder und erleichtern somit das Zuordnen und dienen der Selbstkontrolle.

SORTING SETS FOR THE YOUNGEST

The elements on the wooden cards can be found in the different scenes on the puzzle board and make sorting easy and provide a self-check opportunity.

Puzzelgröße | Puzzle size: 245 × 245 × 8 mm



11030 · JAHRESZEITEN | SEASONS

11040 · UNSER ZUHAUSE |
OUR HOME

11050 · LEBENSÄRÄUME |
ENVIRONMENTS



10139

LAGEN-PUZZLE »KLEINER SCHMETTERLING«

Mit diesem Lagen-Puzzle können schon die Kleinsten spielend leicht die Welt der Schmetterlinge erkunden. Die treppenförmige Aussparung ist spannend und macht neugierig, denn die Motive verkleinern sich und sollten in der richtigen Reihenfolge wieder einsortiert werden. Die stabilen und leicht zu greifenden Holzpuzzleleile lassen die Kleinsten erste motorische Grunderfahrungen machen.

LAYER-PUZZLE »LITTLE BUTTERFLY«

With this layer puzzle for the youngest even babies can easily explore layer by layer. The staircase-shaped gap is exciting and arouses curiosity. The motives are scaled down and should be sorted in correct order. The puzzles encourage colour and shape recognition as well as dexterity.

Puzzlegröße | Box size: 145 x 145 x 20 mm



FÖRdert MOTORIK UND KONZENTRATION
PROMOTES MOTOR SKILLS AND CONCENTRATION



STABILE UND LEICHT ZU GREIFENDE PUZZLETEILE
SOLID AND EASY TO GRAB PUZZLE PIECES



10140

LAGEN-PUZZLE »KLEINER MARIENKÄFER«

Mit diesem Lagen-Puzzle können schon die Kleinsten spielend leicht die Welt der Marienkäfer erkunden. Die treppenförmige Aussparung ist spannend und macht neugierig, denn die Motive verkleinern sich und sollten in der richtigen Reihenfolge wieder einsortiert werden. Dieses neue Lagen-Puzzle aus Holz fördert das Zuordnungs- und Vorstellungsvermögen sowie die Konzentration und innere Ruhe.

LAYER-PUZZLE »LITTLE LADYBIRD«

With this layer puzzle for the youngest even babies can easily explore layer by layer. The staircase-shaped gap is exciting and arouses curiosity. The motives are scaled down and should be sorted in correct order. The puzzles encourage colour and shape recognition as well as dexterity.

Puzzlegröße | Box size: 145 x 145 x 20 mm



ALLE TEILE AUS HOLZ | ALL PARTS MADE OF WOOD





10
tlg. | pcs

LEUCHTENDE FARBEN
BRIGHT COLOURS

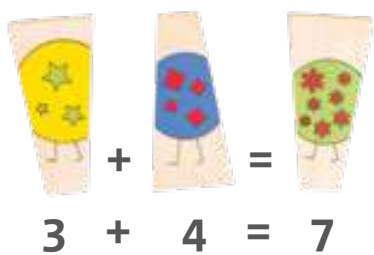
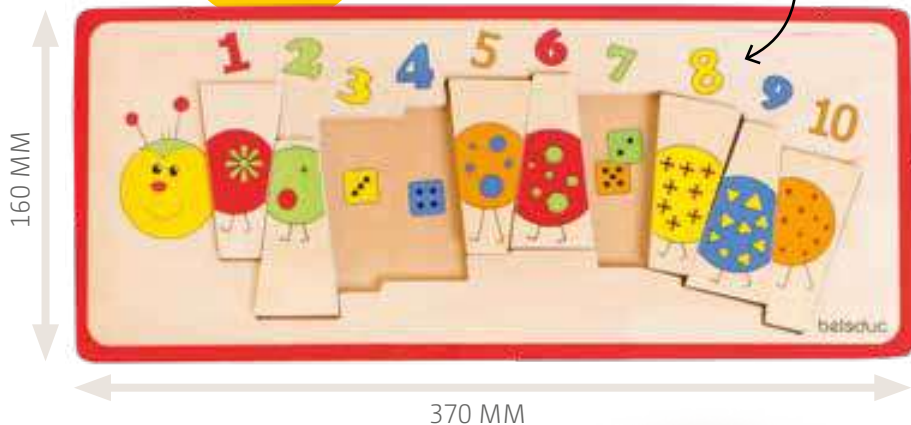

TIPP!



LEGEPUZZLES

Unsere Legepuzzles bringen Kindern erste Grundlagen der Mathematik bei.

MATCHING PUZZLES

Our matching puzzles familiarise children with the basics of mathematics.

Puzzlegröße | Puzzle size: 375 x 160 x 16 mm

3+ FOB

1 11008

ZAHLENRAUPE

Kinder machen sich spielerisch mit dem Zahlenraum von 1 bis 10 und den ersten Schritten der Mengenlehre vertraut.

CATERPILLAR

Children will become familiar with the numbers from 1 to 10 and the first steps of basic arithmetic.

2 11009

FORMENZUG

Unterschiedliche Fensterformen und die darunter abgebildeten Motive bringen den Kindern spielerisch geometrische Formen nahe.

TRAIN

With its amusing windows and the motifs shown underneath children get familiar with different geometric shapes.

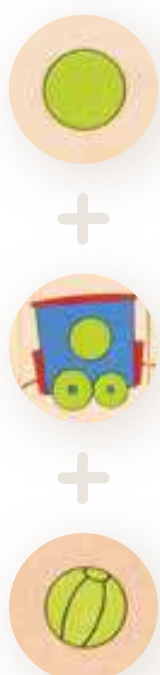

8
tlg. | pcs

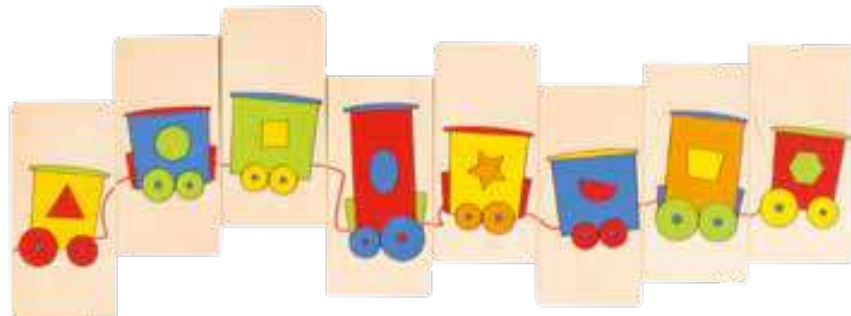



RAHMEN-PUZZLES

Mit unseren Rahmenpuzzles können die Kinder ihnen vertraute Orte und Situationen nachempfinden. Etwas Neues zu entdecken gibt es dabei trotzdem immer wieder. Die stabilen Puzzleteile werden im Rahmen angeordnet und erlauben es so bereits den Jüngsten, erste Puzzerversuche zu unternehmen.

FRAME PUZZLES

With our frame puzzles children can deal with familiar places and situations. However, there is always something new to discover. The sturdy puzzle pieces are arranged in a frame and enable the youngest already to make their first attempts at doing a jigsaw puzzle.

Puzzlegröße | Puzzle size: 405 × 283 × 8 mm



SCAN ME
Kids Video

DETAILREICHE ILLUSTRATIONEN!
DETAILED ILLUSTRATIONS!

HOCHWERTIGE, ROBUSTE
HOLZTEILE
HIGH-QUALITY, ROBUST
WOODEN PIECES

90 MM



12000 · **STADT | TOWN**



12001 · **KINDERGARTEN**



12002 · **MARKT | MARKET**



12010 · **TIERPARK | ZOO**





BODEN-PUZZLE

“ENTDECKE DIE BLUMENWIESE”

Auf der Blumenwiese ist viel los!

There is a lot to discover in the flower meadow!



NEW!

FLOOR PUZZLE “DISCOVER THE FLOWER MEADOW”



16212

BODEN-PUZZLE »ENTDECKE DIE BLUMENWIESE«

Auf der Blumenwiese gibt es viel zu entdecken! Unter der Erde sind viele Tiere unterwegs, aus der Erde kommen schöne Blumen und Pflanzen ans Tageslicht. Hier haben viele Insekten und Tiere ihr Zuhause! Entdecke die Welt der Tiere und Pflanzen.

FLOOR-PUZZLE »DISCOVER THE FLOWER MEADOW«

Many animals are active under the ground and beautiful flowers and plants come out of the ground into the daylight. Many insects and animals have their habitat here! Discover the world of animals and plants. There is a lot to discover here!

Puzzlegröße | Puzzle size: 298 × 630 × 6 mm



JETZT AUF ENTDECKUNGSTOUR GEHEN UND VIELE TOLLE DETAILS FINDEN!
GO ON A DISCOVERY TOUR NOW AND FIND LOTS OF GREAT DETAILS!



3 THEMEN, AUCH EINZELN PUZZLEBAR
3 THEMES, CAN ALSO BE PUZZLED SEPERATLY



3 EINZELNE PUZZLE, DIE ZU EINEM GROSSEN WERDEN!
3 INDIVIDUAL PUZZLES THAT BECOME ONE BIG ONE!

45 PUZZLETEILE AUS HOLZ
45 WOODEN PUZZLE PIECES



Kids Video





BODEN-PUZZLES

Unsere Bodenpuzzles gibt es in zwei Größen und mit unterschiedlicher Teileanzahl. So bieten sie viel Abwechslung. Die großen und griffigen Teile machen kleinen Kinderhänden das Puzzeln besonders einfach.

FLOOR PUZZLES

Our floor puzzles are available in two sizes and with different numbers of pieces. Therefore, they offer much variety. The big and handy pieces make it easy especially for small children's hands to do the puzzle.

TIPP!



16210

BODEN-PUZZLE »ENTDECKE DEN WALD«

Eine spannende Waldszenerie, die dazu einlädt, sie näher zu erforschen! Schaut genau hin, welche Tiere es über und unter der Erde zu bestaunen gibt!

FLOOR PUZZLE »DISCOVER THE FOREST«

An exciting forest scene that invites you to explore it more closely! Take a close look at what animals you can be amazed by above and below the ground!

Puzzlegröße | Puzzle size: 1200 x 145 x 6 mm

TOLLE DETAILS | GREAT DETAILS



4 EINZELPUZZLE = GESAMT 1200 MM
4 INDIVIDUAL PUZZLES = TOTAL 1200 MM

TOLLE DETAILREICHE ILLUSTRATION!
GREAT DETAILED ILLUSTRATION!

GROSSE, GRIFFIGE PUZZLETEILE
AUS HOLZ
BIG, HANDY PUZZLE PIECES
MADE OF WOOD

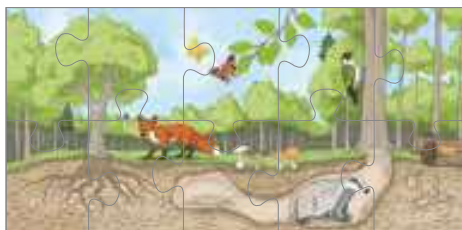

1.



2.

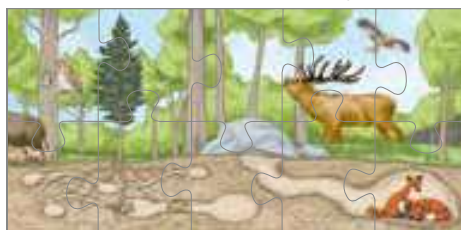

3.

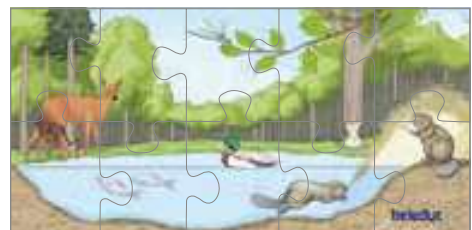

4.

BODEN-PUZZLE

»TIEFSEE BIS WELTALL«



16211

BODEN-PUZZLE »TIEFSEE BIS WELTALL«

Hier gibt es viel zu entdecken! Mit dem U-Boot durch das tiefe Wasser lassen sich viele spannende Lebewesen und bunte Pflanzen erkunden. Welche Tiere verstecken sich zwischen den Bäumen im dichten Dschungel? Wie sieht der galaktische Weltraum aus? Kommt mit auf eine Reise durch die 3 faszinierenden Schichten „Unter Wasser“, „Auf der Erde“ und „Im Weltall“.

FLOOR-PUZZLE »DEEP SEA TO COSMOS«

There is a lot to discover here! By travelling through the deep water in the submarine, you can discover many exciting creatures and colourful plants. Which animals are hiding among the trees in the dense jungle? What does intergalactic space look like? Come along on a journey through the 3 fascinating layers "Under Water", "On Earth" and "In Space".

Puzzlegröße | Puzzle size: 298 × 630 × 6 mm



FLOOR-PUZZLE



**JEDES PUZZLE AUCH
EINZELN PUZZLEBAR!
3 INDIVIDUAL PUZZLES**

**45 PUZZLETEILE AUS HOLZ
45 WOODEN PUZZLE PIECES**





20
tlg. | pcs

**BEST
SELLER**



COGNITO

Spielerisches Lernen leicht gemacht! Ob Wortschatzerweiterung oder räumliche Orientierung, das Erkennen von Unterschieden oder Problemlösung – der Spielspaß steht bei Cognito immer im Mittelpunkt. Mit den Boxen lassen sich kindgerecht mentale Prozesse und Strukturen im Gehirn fördern.

Learning by doing and playing! Expansion of vocabulary or spatial orientation, recognition of differences or solving problems – the focus of Cognito is mainly on the fun of playing. The boxes foster mental processes in children and help to develop the brain structure.



1 11530

RÄUMLICHKEIT

In diesem farbenfrohen Holzlegespiel bestimmen Kinder durch Anwendung von lokalen Präpositionen wie Oben und Unten den exakten Standortbezug von Dingen, dadurch wird das räumliche Denken gefördert.

SPATIALITY

In this colourful wooden puzzle children describe the position of items in a space by using prepositions such as over, under, next to. This trains spatial recognition.



2 11520

GEGENSÄTZE

Kalt oder warm, groß oder klein? Welche Gegensätze sind es? Die Kinder können mithilfe von einfachen Alltagssituationen gegensätzliche Emotionen, Lagen im Raum, Tageszeiten und vieles mehr erfahren.

OPPOSITES

Warm or cold, big or small? Which images show these opposites? Children can learn more about opposing emotions, spatial positions, times of the day and more through the help of simple every-day situations.



3 11540

FORMEN

Welche Form passt zu welchem Gegenstand? Ordne den Kreis und die Uhr zusammen, dann ist es richtig. Kinder erkennen eine zweidimensionale Form und ordnen diese der passenden dreidimensionalen Form zu.

SHAPES

Which shape belongs to which item? Connect the circle with the clock and you can see the connection. Children see a two-dimensional form and connect it to the right three-dimensional item.

Boxgröße | Box size: 149 × 100 × 60 mm

4 11551

KATEGORIEN

Gehört es zur Kategorie der Musikinstrumente, ist es ein Kleidungsstück und passt ein Tennisschläger zu den Werkzeugen? Was gehört zusammen, findet es heraus, denn es gibt viel zu entdecken. Immer 3 Dinge gehören zu einer Kategorie.

CATEGORIES

Is it an instrument or a clothing item and does the tennis racket belong to the tools? Which items can you group together? Find out with this puzzle because there is a lot to discover. 3 different items always belong to one category.

30
tlg. | pcs



5 11500

ZUSAMMENHÄNGE

Siehst du den Zusammenhang? Der Maurer benötigt die Steine, um die Mauer zu bauen, so hast du richtig kombiniert. Kinder können auf drei zueinander passenden Karten einen Ausgangszustand, eine Aktion und ein Ergebnis zusammensetzen.

RECOGNIZE ACTIVITIES

Can you recognise which items belong to which activity? The bricklayer needs the stones to build the wall, so you have guessed correctly. Children can put together three puzzle pieces, depicting a specific material or item, a person using the item and the finished product.



6 11510

ZÄHLEN UND ZAHLEN

Die kleinen lustigen Monster helfen schnell und einfach Zahlen zu lernen und Mengen zu verstehen. Auf drei verschiedenen zusammengehörenden Puzzleteilen ist die vorgegebene Zahl in unterschiedlicher Weise abgebildet – als geometrische Figur zum Nachzählen, als Ziffer und als Würfelaugen.

NUMBERS

The funny little monsters help children to learn numbers and understand quantities easily and quickly. The same number is depicted in different ways on three puzzle pieces which belong together. They can see the numbers as geometric figures for counting, as digits and on a dice.



7 11550

TIERSPUREN/TIERWELTEN

Hier geht es auf eine spannende Spurensuche. Welches Tier lebt wo und hinterlässt welche Spuren. Ist der Fuchs gerade durch den Wald getapst? Dieses Spiel fördert das logische Zusammenbringen von Tieren, deren Lebensräumen und den passenden Spuren.

ANIMAL HABITATS

Here exciting animal tracks can be discovered. Children learn which animal lives where and which traces belong to it. Can you see the fox traipsing through the forest? This puzzle trains logical association of animals, their habitats, and their tracks.



NUR PASSENDE TEILE
KÖNNEN ZUSAMMENGESETZT
WERDEN
ONLY THE CORRECT PIECES
WILL FIT TOGETHER



Boxgröße | Box size: 204 × 100 × 60 mm





NAWITO

„TIERARTEN“



NEW!



150 MM

150 MM

IN PRAKTISCHER
AUFBEWAHRUNGSBOX
IN PRACTICAL
WOODEN BOX

11582

NAWITO »TIERARTEN«

Alle Tiere werden bestimmten Tierarten zugeordnet. In diesem Puzzle lernen Kinder mehr über Säugetiere, Reptilien, Insekten, Fische und Vögel kennen. Das 5-teilige Zuordnungs-Puzzle zeigt 9 unterschiedliche Tiere mit spannenden Details wie Skelett, Ernährung u.v.m.

NAWITO »ANIMAL SPECIES«

All animals are classified according to animal species. In this puzzle, children learn more about mammals, reptiles, insects, fish and birds. The 5-piece matching puzzle shows 9 different animals with exciting details such as skeleton, food and much more.

Boxgröße | Box size: 150 x 150 x 60 mm



TATZE | PAW

BÄRENHÖHLE | BEAR CAVE

FUTTER & POTENSPUR | FEED & PAW PRINT

SKLETT | SKELETON

MIT SELBST-
KONTROLLE
WITH SELF
CONTROL

4+ 45 FOB

45
tlg. | pcs



Corinna Arauner

Illustratorin, Deutschland | *Illustrator, Germany*

„Ich liebe es, Tiere zu illustrieren und ich finde es wundervoll, wie den Kindern mit diesem Puzzle spielerisch Wissen über Tiere vermittelt wird. Besonders spannend finde ich die Ecke mit dem Skelett, auf der die Kinder sehen können, wie ein Tierkörper aufgebaut ist. Zudem kommt die Artenvielfalt unterschiedlichster Tiere toll zur Geltung.“

“I like illustrating animals and I think it’s wonderful how this puzzle teaches the children about animals in a playful way. I love the part with the skeleton, where the children can see how an animal’s body is built. The diversity of species of different animals also comes out great.”



Kids Video

MIT BOOKLET FÜR NOCH MEHR
INFORMATIONEN | WITH BOOKLET
FOR FURTHER INFORMATION



9 VERSCHIEDENE TIERE
9 DIFFERENT ANIMALS

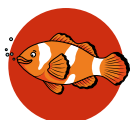
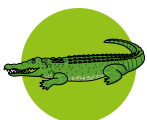



1 11560

NAWITO »HERSTELLUNG«

Dieses 3-teilige Puzzle fördert das logische Kombinieren sowie das kindgerechte Verstehen von Prozessen in der Verarbeitung und Fertigung von Produkten. Woher kommt der Käse, wie entsteht Schokolade und wachsen Pommes aus dem Boden?

NAWITO »PRODUCTION«

This 3-piece puzzle promotes logical combining and the understanding of different steps involved in the processing and manufacturing of products.

Boxgröße | Box size: 150 x 150 x 60 mm



30
tlg. | pcs



2 11570

NAWITO »ENTWICKLUNG«

Natürliche Entwicklungsprozesse sind ein spannendes Thema für neugierige Kinder. Von der Blüte zur Frucht, vom Ei zum Huhn, aber wie war das mit dem Frosch? Das 3-teilige Puzzle fördert die Kombinationsfähigkeit und das Verständnis von Vorgängen in der belebten Natur.

NAWITO »EVOLUTION«

Natural development processes are an exciting topic for curious children. The 3-piece puzzle promotes the ability to combine and the understanding of processes in the natural environment.

Boxgröße | Box size: 150 x 150 x 60 mm



150 MM

NAWITO



120 MM



UNTERSTÜTZUNG DER REIHENFOLGE DURCH DIE PUNKTE ALS ORIENTIERUNG
THE DOTS INDICATE THE CORRECT ORDER

NUR PASSENDE TEILE KÖNNEN ZUSAMMENSETZT WERDEN
ONLY THE CORRECT PIECES WILL FIT TOGETHER

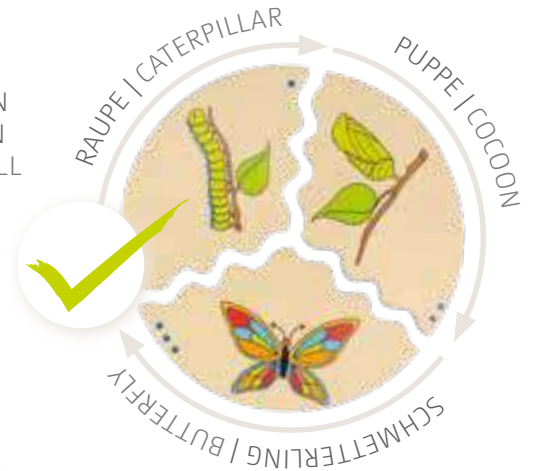

2

10
spannende
Themen in einer
Box | exciting
themes in one
box



NAWITO

**BEST
SELLER**

spiel gut®
vom arbeitsausschuß
kinderspiel + spielzeug
ausgezeichnet
recommended

45
Teile | pieces
9 Themen |
themes

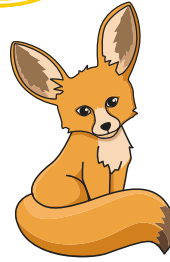

3

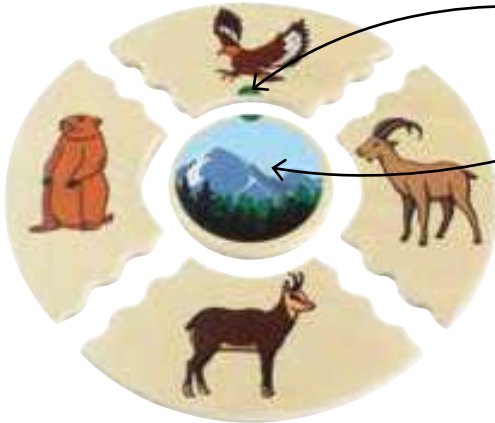

FARBIGE KENNZEICHNUNG
COLOURED MARKING

LEBENSÄRÄUME
HABITAT



MIT PASSENDEM **BOOKLET** FÜR
NOCH MEHR INFORMATIONEN
WITH **BOOKLET** PROVIDING
FURTHER INFORMATION



4

PRÄKTISCHE HOLZBOX
ZUM VERSTAUEN
PRACTICAL WOODEN
BOX FOR STORAGE

30
Teile | pieces
10 Themen |
themes

spiel gut®
vom arbeitsausschuß
kinderspiel + spielzeug
ausgezeichnet
recommended



10 VERSCHIEDENE FRÜCHTE – VON
DER PFLANZE BIS ZUM VERZEHR.
10 DIFFERENT FRUITS - FROM THE
PLANT TO THE FINAL PRODUCT.



3 11580

NAWITO »TIERWELTEN«

Spielerisches Lernen leicht gemacht! Jedes Tier fühlt sich in einer bestimmten Umgebung wohl. Dort findet es Nahrung, Schutz vor Feinden und das richtige Klima. Unser 5-teiliges Puzzle aus Holz zeigt 36 unterschiedliche Tiere, die in dieser Umgebung leben.

NAWITO »ANIMAL HABITATS«

Every animal feels comfortable in a certain environment. There it finds food, protection from enemies and the right climate. Our 5-part puzzle shows 36 different animals and their habitats.

Boxgröße | Box size: 150 × 150 × 60 mm

4+ 45



4 11581

NAWITO »FRÜCHTE«

Spielerisches Lernen leicht gemacht! Wie wächst eine Kiwi? Wie sieht eine Maracuja von Innen aus? Mit unserem 3-teiligen Puzzle aus Holz lernen die Kinder 10 verschiedene Früchte kennen – von der Pflanze bis zum Verzehr.

NAWITO »FRUITS«

How does a kiwi grow? What does a passion fruit look like from the inside? With our 3-part puzzle, the children get to know 10 different fruits – from the plant to the ripe fruit ready for consumption.

Boxgröße | Box size: 150 × 150 × 60 mm

4+ 30



Kids Video



11557

HUMANICO »BERUFE«

In diesem Puzzle dreht sich alles um Berufe! Was machen die Ärztin, der Landwirt, der Feuerwehrmann, der Handwerker und die Polizistin? Jeweils fünf Puzzleteile werden den spannenden Berufen zugeordnet und die Kinder lernen spielerisch, was die einzelnen Berufe tun und warum sie so wichtig für uns alle sind.

HUMANICO »PROFESSIONS«

This puzzle is all about professions. What do the doctor, the farmer, the fireman, the craftsman and the policewoman do? Five puzzle pieces each are matched to the exciting professions and the children playfully learn what the different professions do and why they are so important for us.

Boxgröße | Box size: 180 × 180 × 60 mm



HUMANICO

»BERUFE«



PRAKTISCHE HOLZBOX
ZUM VERSTAUEN
PRACTICAL WOODEN
BOX FOR STORAGE



MIT PASSENDEM BOOKLET
FÜR NOCH MEHR
INFORMATIONEN | WITH
BOOKLET PROVIDING
FURTHER INFORMATION





HUMANICO "EMOTIONEN"



30

Teile | pieces
5 Themen |
themes

1 11555

HUMANICO »EMOTIONEN«

Bei HUMANICO Emotionen geht es um Gefühle und Emotionen wie Angst, Traurigkeit, Wut, Überraschung und Glück, die uns ein Leben lang begleiten. Mit diesen Emotionen werden unsere inneren Wünsche, Ziele und Bedürfnisse verkörpert. Sie erfolgen als Reaktion auf einen Zustand oder eine Situation. Häufig erleben Kinder Gefühle sehr intensiv, umso wichtiger ist es, dass sie lernen, klug mit ihren Gefühlen umzugehen und sie angemessen auszudrücken.

HUMANICO »EMOTIONS«

Feelings are emotions like fear, sadness, anger, surprise, and happiness, which accompany us throughout our lives. These emotions embody our inner wishes, goals and needs. They are a reaction to a situation or a condition. Children oftentimes experience intense emotions, which makes it even more important for them to learn how to cope with them and express them in the right way.



1

MIT PRAKTISCHER
AUFBEWAHRUNGSBOX
IN PRACTICAL STORAGE BOX



5 EMOTIONEN MIT JE
5 PASSENDE SITUATIONEN
5 EMOTIONS WITH 5 CORRESPONDING SITUATIONS EACH

Boxgröße | Box size: 180 x 180 x 60 mm

4+ 30 FOB



160 MM



MIT BOOKLET FÜR NOCH
MEHR INFORMATIONEN
WITH BOOKLET FOR
FURTHER INFORMATION

30 PUZZLE-TEILE
AUS HOLZ
30 WOODEN
PUZZLE PIECES



Kids Video



2 11556

HUMANICO »5 SINNE«

In diesem Puzzle geht es um Erkennen, Zuordnen und Begreifen der fünf Sinne: Sehen, Hören, Riechen, Schmecken und Tasten. Das wird im Spiel- und Puzzeverlauf und in unterschiedlichen Spielvarianten durch Wahrnehmung, Sensibilisierung und sprachliche Artikulation vermittelt und geübt.

HUMANICO »5 SENSES«

This puzzle is all about recognising, correlating and understanding our five senses: vision, hearing, smell, tasting and touch. These aspects will be conveyed and trained through different game variations using perception, sensitisation, and linguistic articulation.

Boxgröße | Box size: 180 x 180 x 60 mm



HUMANICO

»5 SINNE«

30
Teile | pieces
5 Themen |
themes



160 MM



2
PRAKTISCHE HOLZBOX
ZUM VERSTAUEN
PRACTICAL WOODEN
BOX FOR STORAGE

Ø
160 mm





MATCH & MIX



11180

MATCH & MIX »MONSTER«

Die Monster sind los! Kleine freche Monster wirbeln durcheinander. Die Figuren können entweder farblich passend zusammengepuzzelt oder fantasievoll gemixt werden. Erfindet lustige Geschichten zu den gepuzzelten Monstern und tauscht euch über Details aus, die euch auffallen.

MATCH & MIX »MONSTER«

The monsters are on the loose! Little cheeky monsters are all mixed up. The figures can either be matched together by colour or mixed imaginatively. Make up funny stories about the puzzled monsters and talk about details that you notice.

Puzzlegröße | Puzzle size: 289 x 336 x 9 mm



AUCH ALS MEMO-VARIANTE SPIELBAR
ALSO PLAYABLE AS A MEMORY GAME

HIER SIND DER FANTASIE KEINE
GRENZEN GESETZT
THERE ARE NO LIMITS TO THE IMAGINATION

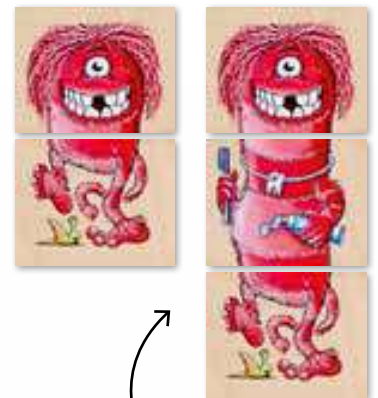

2- UND 3-TEILIG
KOMBINIERBAR
2- OR 3 PIECES
CAN BE COMBINED





MATCH & MIX

Die Match & Mix Serie regt Kinder dazu an ihrer Fantasie freien Lauf zu lassen! So können spannende Fantasiefiguren entstehen und lustige Geschichten zu ihnen erfunden werden oder die Teile passend zusammengefügt werden.

The Match & Mix series invites children to be creative! They can create exciting fantasy figures and make up funny stories or the matching pieces can be put together.

Puzzlegröße | Puzzle size: 289 × 336 × 9 mm

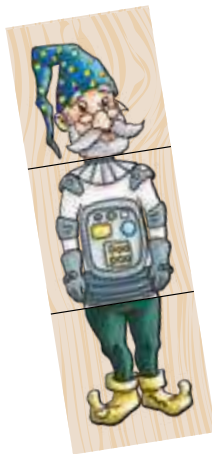

MATCH & MIX FANTASY UND KINDER SIND KOMBINIERBAR
MATCH & MIX FANTASY AND KIDS CAN BE COMBINED



11150 · FANTASY

Eine Prinzessin mit Lasso oder ein Zwerg mit Flosse? Mit diesem lustigen Puzzle ist alles möglich. Puzzelt die Fantasiefiguren passend zusammen oder kreiert ganz neue Figuren.

A princess with a lasso or a dwarf with flippers? Anything is possible in this fun puzzle. Put the fantasy characters together correctly using their clothing or create completely new characters.

11130 · KINDER | KIDS

Hier haben sich ganz viele Kinder verschiedener Nationen zusammengefunden. Die Kinder werden ihren Merkmalen entsprechend gepuzzelt. Es können aber auch lustige Fantasiekinder entstehen.

Many children from different nations have come together. The children are puzzled according to their characteristics. However, funny fantasy kids can be created, as well.

11160 · ANIMAL KINGDOM

Wie sieht wohl eine Mischung aus Ente, Krokodil und Leopard – ein En-Ko-Pard – aus? Puzzelt Fantasietiere oder versucht die acht Tiere passend zusammensetzen.

What does a mixture of duck, crocodile and leopard – a du-co-pard – look like? Create fantasy animals or try to put the eight animals together correctly.



Unser beleduc-Tipp

5 IN 1 PUZZLES



AUFBAUHILFE DURCH
STUFENEFFEKT
STEP-BY-STEP
CONSTRUCTION AID



KÖRPER-PUZZLES BODY-PUZZLES

Puzzlegröße | Puzzle size:
145 x 295 x 20 mm

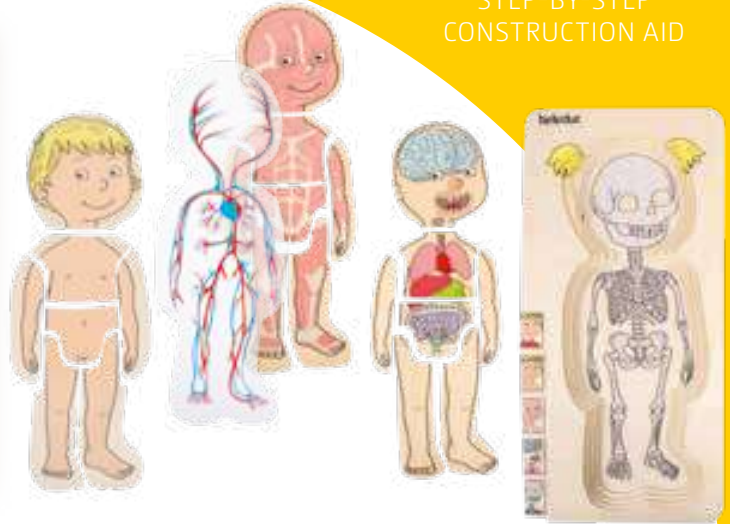

17160 · KÖRPER-PUZZLE »MÄDCHEN«
BODY-PUZZLE »GIRL«



17170 · KÖRPER-PUZZLE »JUNGE«
BODY-PUZZLE »BOY«



EXTRA FOLIE MIT DARSTELLUNG
DES BLUTKREISLAUFES
EXTRA TRANSPARENT FOIL
DEPICITING THE BLOOD
CIRCULATION

Our beleduc-tip

5 IN 1 PUZZLES



17052

LAGEN-PUZZLE »OMA & OPA«

Dieses Generationenpuzzle zeigt die verschiedenen Lebensphasen eines Menschen vom Baby bis hin zum Seniorenalter.

LAYER-PUZZLE »GRANDMA & GRANDPA«

This generation puzzle shows the different life stages of a human from baby to senior citizen.

Puzzlegröße | Puzzle size: 295 × 207 × 18 mm

4+  FOB 



17024

LAGEN-PUZZLE »MUTTER«

Dieses Lagen-Puzzle vermittelt die Entwicklung eines Kindes und den Verlauf einer Schwangerschaft.

LAYER-PUZZLE »MOTHER«

This layer-puzzle shows the formation of a child and the course of a pregnancy.

Puzzlegröße | Puzzle size: 145 × 295 × 20 mm

4+  FOB 



17058

LAGEN-PUZZLE-SET »ANIKA & DENIS«

Auf spielerische Art Körperteile erkennen und benennen.

LAYER-PUZZLE-SET »ANIKA & DENIS«

Identify and name body parts through play.

Puzzlegröße | Puzzle size: 140 × 293 × 7 mm

3+  FOB

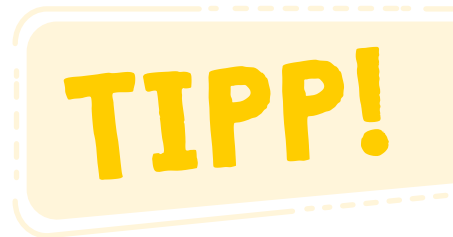



ENTWICKLUNG – OBST & GEMÜSE

Die Reihe der Obst & Gemüse Puzzles erklärt auf kindliche Art und Weise, wie sich Pflanzen entwickeln und am Ende eine Frucht entsteht.

DEVELOPMENT – FRUITS & VEGETABLES

The series of fruit & vegetable puzzles explains in a child-friendly way how plants grow and ripe fruits develop.

Puzzlegröße | Puzzle size: 145 × 145 × 18 mm



17044 · LAGEN-PUZZLE »KAROTTE«
LAYER-PUZZLE »CARROT«



1. BODEN | BOTTOM



5.



2.

MIT NUMMERIERUNG
AUF DER RÜCKSEITE
WITH NUMBERING
ON THE BACK



3.



4.



LAGENPUZZLE 5 IN 1 | LAYERPUZZLE 5 IN 1



17043 · LAGEN-PUZZLE »KARTOFFEL« | LAYER-PUZZLE »POTATO«



17040 · LAGEN-PUZZLE »ERDBEERE« | LAYER-PUZZLE »STRAWBERRY«



17049 · LAGEN-PUZZLE »BANANE« | LAYER-PUZZLE »BANANA«



17039 · LAGEN-PUZZLE »APFEL« | LAYER-PUZZLE »APPLE«



**BEST
SELLER**

JEDES PUZZLE EINE
GANZE GESCHICHTE
EVERY PUZZLE
A WHOLE STORY



ENTWICKLUNG – TIERE

Die Entwicklung von Tieren ist sehr unterschiedlich und kann mit Hilfe der Entwicklungs-
puzzles Tiere schnell nachvollzogen werden.

DEVELOPMENT – ANIMALS

The development of animals varies a lot and
can be understood easily with the help of these
development puzzles.

Puzzlegröße | Puzzle size: 205 × 205 × 20 mm

4+ FOB



17053 · LAGEN-PUZZLE »FROSCH«
LAYER-PUZZLE »FROG«



spiel gut®
vom arbeitsausschuß
kinderspiel + spielzeug
ausgezeichnet
recommended

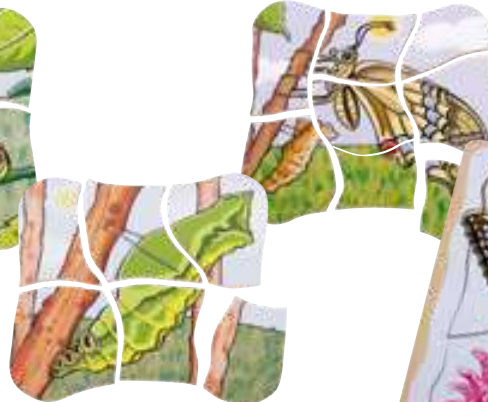

17054 · LAGEN-PUZZLE »SCHMETTERLING«
LAYER-PUZZLE »BUTTERFLY«



spiel gut®
vom arbeitsausschuß
kinderspiel + spielzeug
ausgezeichnet
recommended

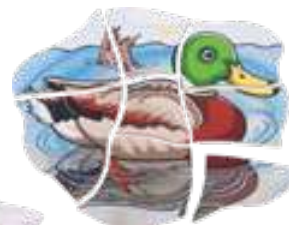

17055 · LAGEN-PUZZLE »ENTE«
LAYER-PUZZLE »DUCK«



17060

LAGEN-PUZZLE »HONIG«

Die goldgelbe Flüssigkeit – Honig genannt – schmeckt Kindern auf dem Brot! Doch woher kommt der Honig eigentlich? Viele fleißige Bienen sammeln Unmengen an Blumennektar, um Honig produzieren zu können! Ein Imker sammelt den Honig dann, sodass er im Kindermund landen kann. Das Puzzle ermöglicht ein Sehen und Verstehen in Bildern.

LAYER-PUZZLE »HONEY«

The golden yellow liquid – named honey – tastes good to children! But where does the honey come from? Busy bees collect large quantities of nectar from flowers to produce honey! A beekeeper collects it afterwards so the children can enjoy the honey. The puzzle enables a seeing and understanding in pictures.

Puzzelgröße | Puzzle size: 205 × 205 × 20 mm



TIPP!



BODEN
BOTTOM



4.

MIT NUMMIERUNG
AUF DER RÜCKSEITE
WITH NUMBERING ON THE BACK



1.



2.



3.



LAGEN-PUZZLE "ZUHAUSE"



17061

LAGEN-PUZZLE »ZUHAUSE«

Wer wohnt denn hier? Schau in das Innere des Hauses und verfolge die Beschäftigungen der Familie. Was gibt es in den verschiedenen Räumen bei Tag und bei Nacht zu entdecken? Dieses spannende Lagenpuzzle zeigt die verschiedenen Aktivitäten der Hausbewohner zu unterschiedlichen Tageszeiten. Wann wird gegessen oder wer spielt mit dem Hund? Der Blick in den dunklen Garten mit den leuchtenden Details ist dabei ein ganz besonderes Highlight!

LAYER-PUZZLE »HOME«

Who lives here? Look inside the house and follow the family's activities. What can you discover in the different rooms by day and by night? This exciting layer-puzzle shows what different family members do during different times in the day. When are they eating and who is playing with the dog? Viewing the garden by night with all its luminous details is a special highlight!

Puzzlegröße | Puzzle size: 245 x 297 x 18 mm

4+ FOB



LEUCHTET IM DUNKELN | GLOW IN THE DARK



SPECIAL EFFECT!

NUMMERIERUNG AUF DER RÜCKSEITE
NUMBERS ON THE BACK

LAYER-PUZZLE HOME

EFFEKTIVOLLE
GLOW-IN-THE-DARK
FARBE | GLOW-IN-THE-
DARK-COLOURS

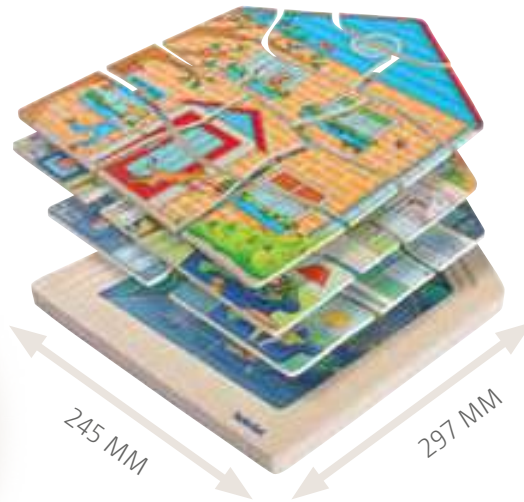

4-IN-1 PUZZLE



LAGEN-PUZZLE
»EINE GANZE GESCHICHTE«

Die Lagen-Puzzles "Eine ganze Geschichte" laden Kinder dazu ein sich über die Inhalte der Puzzles auszutauschen. Neben den sprachlichen Fähigkeiten, werden die Auffassungsgabe und das Erkennen von Zusammenhängen geschult.

LAYER-PUZZLE
»A WHOLE STORY«

The layer-puzzles „A Whole Story“ invite children to talk about the subject provided by the puzzle. In that way children improve their language skills, perception and the recognition of relationships.



FRÜHLING | SPRING



SOMMER | SUMMER



HERBST | AUTUMN



WINTER



17150

LAGEN-PUZZLE
»4 JAHRESZEITEN«

Tom und Lisa zeigen uns den Wandel der Jahreszeiten.

LAYER-PUZZLE »4 SEASONS«

Tom and Lisa are showing us the changes of the seasons.

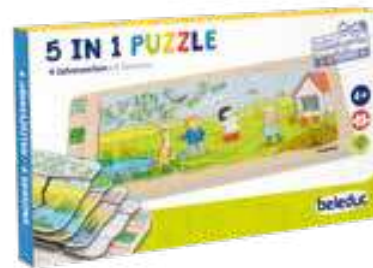

Puzzlegroße | Puzzle size: 290 × 140 × 18 mm



17035

LAGEN-PUZZLE »FEUERWEHR«

Das Puzzle zeigt den Einsatz der Feuerwehr bei einem Wohnungsbrand, vom Alarm bis hin zur Rückkehr in die Feuerwache.

LAYER-PUZZLE »FIRE BRIGADE«

The puzzle shows the fire brigade in action when a house is on fire. The layers start with the alarm going off and finish with the fire brigade returning to the fire station.

Puzzlegroße | Puzzle size: 295 × 207 × 18 mm



LAGE 1 | LAYER 1



LAGE 2 | LAYER 2

MIT NUMMERIERUNG
 AUF DER RÜCKSEITE
 WITH NUMBERING
 ON THE BACK



LAGE 3 | LAYER 3



LAGE 4 | LAYER 4



LAGE 5 | LAYER 5





XXL WILD ANIMALS PUZZLE

*Finde die wilden Tiere!
Find the wild animals!*

+ Inklusive
Poster
Including
poster



NEW!



11014

XXL WILD ANIMALS PUZZLE

Finde die wilden Tiere! In diesem fantasievol-
len und spannenden Puzzle verstecken sich
allerlei wilde Tiere. Durch das bunte Muster
des Dschungel-Mandalas sind sie kaum zu
entdecken. Erst mit der Rückseite zeigen sich
die Tiere und ihre Besonderheiten. Das Puzzle
kann in drei Varianten mit unterschiedlichen
Schwierigkeitsstufen – mit und ohne Poster –
zusammengesetzt werden.

Find the wild animals! All kinds of wild animals
are hiding in this imaginative and exciting puzzle.
The colourful pattern of the jungle mandala
makes them hard to discover. Only with turning
the puzzle pieces of the animals around to show
the backside do the animals and their special
features become visible. The puzzle can be put
together in three variations with different diffi-
culty levels – with and without poster.

Puzzlegröße | Puzzle size: Ø 490 × 6 mm

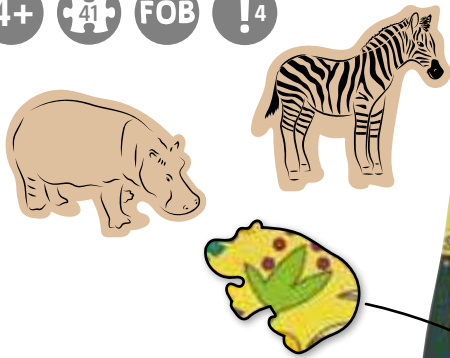

10 WILDE TIERE VERSTECKEN SICH
IM PUZZLE – WER ENTDECKT SIE?
10 WILD ANIMALS ARE HIDING
IN THE PUZZLE – WHO WILL
DISCOVER THEM?

WEITERE SPIEL-IDEEN MIT DEN TIEREN | MORE GAME IDEAS WITH THE ANIMALS



10 UNTERSCHIEDLICHE TIERE
10 DIFFERENT ANIMALS



BEIDSEITIG BEDRUCKT



41 XL PUZZLE-TEILE AUS HOLZ
41 XL PUZZLE PIECES MADE
FROM WOOD

10 VERSTECKTE TIERE
10 HIDDEN ANIMALS

3 PUZZLE-VARIANTEN
3 PUZZLE VARIANTS

INKLUSIVE ORIGINAL-
POSTER 50 × 50 CM
INCLUDING ORIGINAL
POSTER 50 × 50 CM

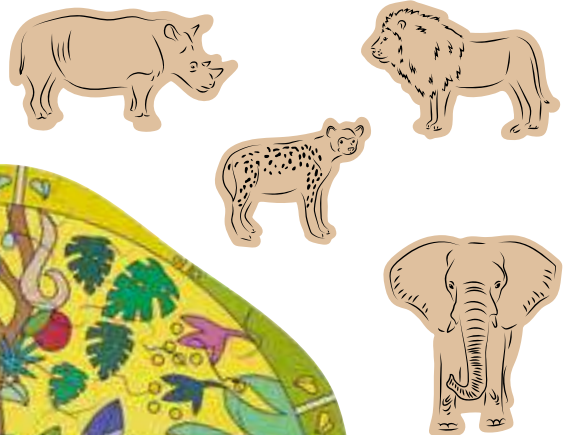

Kids Video

MEHR ZUSATZMATERIAL ZUM
DOWNLOAD | MORE ADDITIONAL
MATERIAL FOR DOWNLOAD
www.beleduc.de

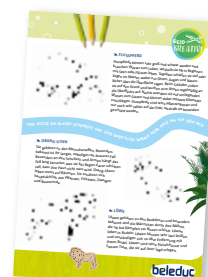



XXL FANTASY PUZZLE

»INSEKTEN«



11013

XXL FANTASY PUZZLE »INSEKTEN«

Finde die versteckten Insekten! Dieses XXL Puzzle zeigt kindgerecht die verschiedenen Arten der Insekten. Die Insekten sind beidseitig bedruckt und können sowohl mit der Vorder-, als auch mit der Rückseite angelegt werden, was den Kindern viele verschiedene Möglichkeiten zum Puzzeln eröffnet. Inkl. Poster, damit jeder entscheidet, wie gepuzzelt wird – mit oder ohne Poster.

XXL FANTASY PUZZLE »INSECTS«

Find the hidden insects! This XXL puzzle shows different types of insects in a child-friendly way. The insects are printed differently on both sides and can be put on with the front as well as the back, which offers the children many different possibilities for the puzzle. Incl. poster, everyone can decide how to puzzle – with or without poster.

Puzzlegröße | Puzzle size: Ø 490 × 6 mm



MEHR ZUSATZMATERIAL ZUM
DOWNLOAD | MORE ADDITIONAL
MATERIAL FOR DOWNLOAD
www.beleduc.de



Kids Video

46 XL PUZZLE-TEILE AUS HOLZ
46 XL WOODEN PUZZLE PIECES
3 PUZZLE-VARIANTEN
3 PUZZLE VARIATIONS



+ Inklusive Poster
+ Including poster

15 INSEKTEN
BEIDSEITIG BEDRUCKT
15 INSECTS PRINTED
ON BOTH SIDES

Ø
490 MM

15 VERSTECKTE INSEKTEN
15 HIDDEN INSECTS



11300

BLOCK PUZZLE »BAUERNHOF«

Nebeneinander, übereinander, durcheinander... hier ist Fantasie gefragt! Die vielseitigen Blockpuzzle-Elemente können beliebig miteinander kombiniert werden. 10 spannende Vorlagen bieten den Kindern die Möglichkeit interessante Bauernhofwelten aufzubauen. Es können eigene Geschichten erzählt und nachgebaut werden.

BLOCK PUZZLE »FARM«

Next to each other, on top of each other, mixed up... imagination is called for here! The versatile block puzzle elements can be combined as desired. 10 exciting templates offer children the opportunity to create interesting farm worlds. Own stories can be told and sceneries can be build.

Boxgröße | Box size: 240 × 185 × 100 mm



DIE BAUSTEINE SIND 4 SEITIG UND MIT UNTERSCHIEDLICHEN MOTIVEN BEDRUCKT
 THE BLOCKS ARE PRINTED ON FOUR SIDES WITH DIFFERENT MOTIFS

KINDER KÖNNEN VERTIKAL, HORIZONTAL UND SOGAR DREIDIMENSIONAL BAUEN
 KIDS CAN PLAY AND CREATE SCENERIES VERTICALLY, HORIZONTALLY AND THREE-Dimensionally



12 HOCHWERTIG
 BEDRUCKTE BLÖCKE
 12 HIGH-QUALITY
 PRINTED BLOCKS

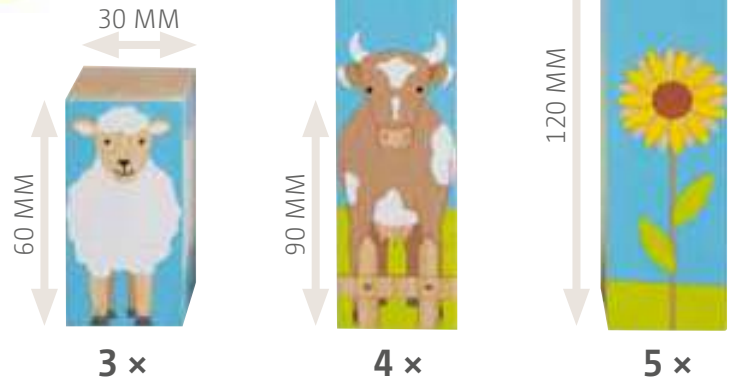

DIE VORLAGEN KÖNNEN EINFACH NACHGEBAUT
 WERDEN ODER DIE BLOCK PUZZLE-ELEMENTE
 KÖNNEN KREATIV KOMBINIERT WERDEN
 THE SCENERIES ON THE TEMPLATE CARDS
 CAN BE REBUILD OR THE WOODEN PIECES
 CAN BE COMBINED CREATIVELY



DREIDIMENSIONALES BAUEN | THREE-Dimensionally BUILDING



5 VORLAGE-KARTEN MIT
 10 TOLLEN MOTIVEN
 5 TEMPLATE CARDS WITH
 10 GREAT MOTIFS

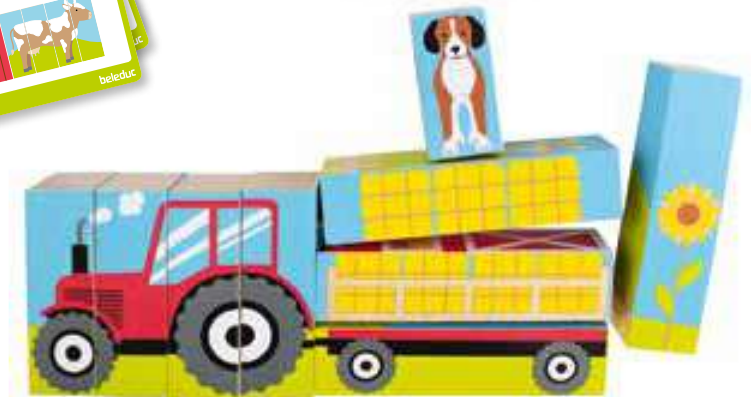
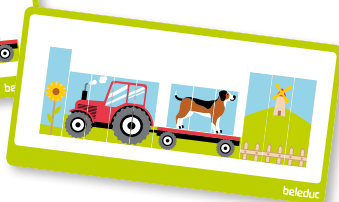



KIDS OF THE WORLD



KREATIVES FREISPIEL UND NACHBAUEN
DER VORLAGE-KARTEN MÖGLICH
POSSIBILITIES FOR CREATIVE FREE PLAY
OR RECREATING TEMPLATE CRADS

PRAKTISCHE MAGNETBOX
ZUR AUFBEWAHRUNG
PRACTICAL MAGNETIC STORAGE BOX



35
Magnetteile
Magnetic
pieces



7 VORLAGE-KARTEN
7 TEMPLATE CARDS



11190

MAGNETIC GAME »KINDER UND TIERE DER WELT«

Dieses Match & Mix Magnetspiel stellt Tiere und Kinder von unterschiedlichen Kontinenten dar. Die Vorlagekarten zeigen woher die Kinder in ihrer traditionellen Kleidung sowie ihre süßen Tierbegleiter stammen. Die Magnet-Teile können passend zusammengepuzzelt oder lustig und kreativ untereinander kombiniert werden.

MAGNETIC GAME »KIDS AND ANIMALS OF THE WORLD«

This Match & Mix magnetic toy shows animals and children from different continents. The template cards explain where the children in traditional clothing and their cute animal friends come from. The magnetic pieces can be assembled as shown on the cards or combined creatively.

Boxgröße | Box size: 195 × 265 × 40 mm



10151

»ONE WORLD« PUZZLE

Dieses Puzzle lässt Kinder zu Entdeckern werden. This puzzle lets children become explorers.

Boxgröße | Box size: 195 × 265 × 40 mm





11200

XXL LERNPUZZLE »ENTDECKE DIE WELT«

Die Welt zu erkunden ist eine spannende Angelegenheit, denn es gibt so viel zu entdecken. In der Mitte des Puzzles befindet sich ein Kompass und eine kleine Weltkarte, auf der die verschiedenen Kontinente abgebildet sind. Der erste Ring zeigt jeweils 2 Kinder in charakteristischer Kleidung des Kontinents, woraufhin ein Ring mit typischen Tieren folgt. Der äußere Ring zeigt landesspezifische Bauwerke und Landschaften. Die einzelnen Ringe sind frei drehbar, können also auch einzeln verwendet werden oder im gesamten Puzzle an die entsprechende Stelle gedreht werden.

XXL LEARNING PUZZLE »DISCOVER THE WORLD«

Exploring the world is exciting – there's so much to discover! In the middle of the puzzle there is a compass and a small world map featuring the different continents. The first ring shows 2 children dressed in traditional clothing for each continent. The second ring features typical local animals, while the outer ring shows country specific buildings and landscapes. Each ring can be used individually or rotated to the correct position in the puzzle.

Puzzelgröße | Puzzle size: Ø 490 x 6 mm



DAS PASSENDE SPIEL ZUR SERIE AUF SEITE 77
THE GAME TO THIS SERIES ON PAGE 77



MIT KOMPASS
WITH A COMPASS

45 PUZZLETEILE
AUS HOLZ
45 WOODEN
PUZZLE PIECES

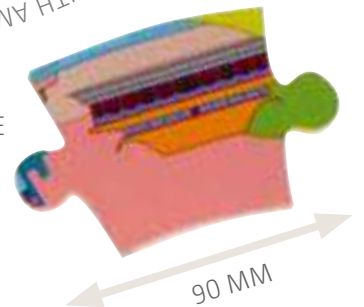

Ø
490 MM





MIT ROTEM PLEXIGLAS WERDEN
DIE BEREICHE SICHTBAR
THE AREAS BECOME VISIBLE
WITH RED PLEXIGLASS

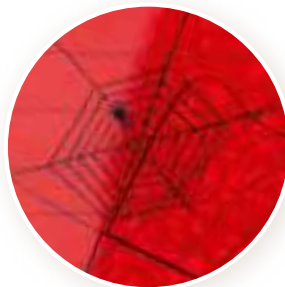

FINDE DIE SYMBOLE, DIE IM
PUZZLE VERSTECKT SIND
FIND THE SYMBOLS THAT ARE
HIDDEN IN THE PUZZLE

Ø
490 MM



TIPP!



FINDE DIE SYMBOLE AM
RAND MITHILFE DER LUPE
FIND THE SYMBOLS ON
THE FRAME BY USING
THE MAGNIFIER

TOLLE DETAILREICHE
ILLUSTRATION
GREAT DETAILED
ILLUSTRATION



11170

XXL LERNPUZZLE »DETEKTIV«

Dieses Puzzle macht es uns leicht Dinge herauszufinden, zu entdecken, genau hinzuschauen und zu suchen. Das rote Plexiglas in der Mitte kann herausgenommen und auf die Bereiche gelegt werden, die erst mal rot und „undurchsichtig“ erscheinen. Schaut genau hin, was ihr jetzt alles beobachten könnt!! Außerdem ist der Rand gespickt mit Symbolen. Könnt ihr diese alle auf dem Puzzle wiederfinden?

XXL LEARNING PUZZLE »DETECTIVE«

This puzzle makes it easy to find things out, to discover, to look closely and to search. The red plexiglass screen in the middle can be removed and placed on the areas that at first appear red and "opaque". Take a close look and see what you can observe!! Also, the margin is full of symbols. Can you find all of them on the puzzle?

Puzzlegröße | Puzzle size: Ø 490 × 6 mm



11140

XXL LERNPUZZLE »FLUGHAFEN«

Unser XXL Lernpuzzle nimmt Kinder mit auf eine spannende Flugreise. Hier sind die wichtigsten Stationen abgebildet. Vom Check-In, Verhalten im Flugzeug bis zur Ankunft im Urlaubsland. Mithilfe der Lupe können verschiedene Dinge entdeckt werden.

XXL LEARNING PUZZLE »AIRPORT«

Our XXL Learning Puzzle takes children on a fascinating air travel. The most important stations of an air travel are shown. With the aid of the magnifying glass children can discover different items.

Puzzlegröße | Puzzle size: Ø 490 × 6 mm





11012

XXL LERNPUZZLE »MEIN TAG«

Unser XXL Lernpuzzle „Mein Tag“ begleitet die Kinder durch ihren Tagesablauf und führt sie auf spielerische Weise an die Uhrzeit heran. Anhand des Puzzles lassen sich vertraute Abläufe erkennen und benennen.

XXL LEARNING PUZZLE »MY DAY«

Our XXL Learning Puzzle „My Day“ accompanies children through their daily activities and takes a preliminary approach to telling the time in a playfully context. The puzzle provides an opportunity to recognise and name familiar procedures.

Puzzlegröße | Puzzle size: Ø 490 × 6 mm



AUFBEWAHRUNG DER
49 HOLZ-TEILE IM
PRAKTISCHEN KOFFER
STORAGE OF
49 WOODEN PIECES
IN A PRACTICAL CASE

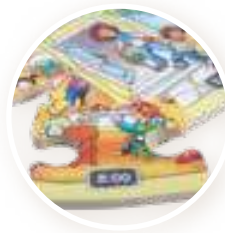

DARSTELLUNG
VON ANALOG- UND
DIGITAL-UHRZEIT
THE PICTURE SHOWS
ANALOGUE AND DIGITAL TIME



11011

XXL LERNPUZZLE »4 JAHRESZEITEN«

Unser XXL Lernpuzzle „4 Jahreszeiten“ bietet Kindern die Möglichkeit, sich spielerisch mit den Jahreszeiten und dem Jahresverlauf vertraut zu machen. Es lädt ein, die einzelnen Monate mit ihren Besonderheiten zu erkunden.

XXL LEARNING PUZZLE »4 SEASONS«

Our XXL Learning Puzzle „4 Seasons“ gives children an opportunity to playfully familiarise themselves with the seasons and the course of the year. It encourages them to explore the individual months and their seasonal characteristics.

Puzzlegröße | Puzzle size: Ø 490 × 6 mm





SPIELE GAMES

Besonderer Lern-Spiel-Spaß für alle kleinen Entdecker!
For all young explorers: Learning, Playing, Having Fun!





Anne Kathrin Schöner

Produktentwicklung & Design beleduc, Deutschland
Product development & design beleduc, Germany

„Mein Herzenthema ist es, eine Leichtigkeit in die Spiele zu bringen, die die Kids ermutigt, spielerisch neue Dinge zu erlernen und einen Moment zu schaffen, miteinander Spaß zu haben. Von der ersten Spielidee über die Illustration und Namensfindung bis hin zur finalen Produktion ist die gesamte Spielentwicklung ein sehr spannender Weg. Besonders das Spiel um die Zwerge „Happy & Harmony“ gefällt mir gut, die Illustrationen und Spielmaterialien sind für die Kinder ansprechend gestaltet und die Spielregeln schnell und einfach verstanden. Und alles, was man spielerisch lernt, behält man sich sehr gut.“

“My heart theme is to bring a lightness to the games. I develop and track many games from conception to production stage. This is because I have a deep passion to bring fun and enjoyment into the games that teach and encourage the kids to learn new things while also create team work. From the initial creation of games to the naming like gnomes “Happy and Harmony” the entire development process, editing and illustration we try to make rules very appealing and quickly understandable to the children and everyone else. This makes everything you learn through playing the games easy to remember.”

Happy & Harmony | Dieses Produkt finden Sie auf Seite 62–63
Happy & Harmony | You can find this product on page 62–63



QUAKI



Fangt die Fliegen!
Catch the flies!

NEW!



UNBEDINGT ANSCHAUEN! | HAVE A LOOK!

Kids Video



22619

QUAKI

Auf dem Seerosenteich ist einiges los! Dieses spannende und abwechslungsreiche Spiel erfordert eine gute Merkfähigkeit. Die Spieler müssen versuchen so viele Fliegen wie möglich – mithilfe der magnetischen Frösche – zu schnappen und auf der eigenen Spielmatte zu sammeln. Ziel des Spiels ist es, als erster alle Fliegenfelder auf der eigenen Frosch-Spielmatte zu besetzen.

There is a lot going on in the water lily pond! The players try to catch the flies with their frogs and be the first to catch as many flies as possible. This exciting and varied game requires a quick reaction and good memory skills. The players try to catch as many flies as possible and collect them on their own game mat. The aim of the game is to be the first to fill all the fly squares on your own small frog game mat.

Boxgröße | Box size: 450 × 120 × 120 mm



MAGNET

35 MM



**FANGT DIE FLIEGEN!
CATCH THE FLIES!**

**MERKFÄHIGKEIT &
FARBBERKENNUNG!
MEMORY & COLOUR
RECOGNITION!**

**FINDE DIE MAGNETISCHEN
FLIEGEN!
FIND THE MAGNETIC
FLIES!**

SPIELMATTE AUS TEXTIL & GUMMI | ROBUST MAT – MADE OF RUBBER & TEXTILE



400 MM

MAGNET
MAGNET

36 FLIEGENCHIPS, DAVON
24 MAGNETISCH
36 FLY CHIPS, 24 MAGNETIC





HAPPY & HARMONY

Lustige Zwerge erobern den Garten!
Funny gnomes conquer the garden!

NEW!





22620

HAPPY & HARMONY

Die lustigen Zwerge „Happy und Harmony“ wollen ihren Garten bepflanzen und dazu müssen sie ihre Flächen im Garten aufteilen. Hilf den Zwergen herauszufinden, wer welche Fläche bepflanzen darf. Hier sind Kombination und Spielübersicht gefragt. Ziel des Spiels ist es, den 4. Zaun ein Feld zu setzen und das jeweilige Gartenstück zu gewinnen. Gewonnen hat derjenige, der die meisten Zwerge seiner Farbe platziert hat.

The gnomes Happy and Harmony want to plant their garden. To do this, they have to divide their areas in the garden. Help the gnomes to find out who gets to plant which area. Combination and game overview are needed to win as many areas as possible.

Boxgröße | Box size: 240 × 240 × 60 mm



24 GARTENZÄUNE,
8 ROTE ZWERGE HAPPY,
8 BLAUE ZWERGE HARMONY
24 GARDEN FENCES,
8 RED GNOMES HAPPY,
8 BLUE GNOMES HARMONY



240 MM



LUSTIGE ZWERGE EROBERN DEN GARTEN!
FUNNY GNOMES CONQUER THE GARDEN!



16 ZWERGE & 24 GARTENZÄUNE
AUS HOLZ
16 FUNNY WOODEN GNOMES &
24 WOODEN GARDEN FENCES

DAS ZWERGENSPIEL FÜR ZWEI –
MIT SPIELVARIANTE „TIC-TAC-TOE“
THE GNOME GAME FOR TWO –
WITH GAME VARIANT TIC-TAC-TOE

FÖRdert LOGISCHES UND
RÄUMLICHES DENKEN
LEARNING AREA CONCEPTS AND
UNDERSTANDING AREA SIZES



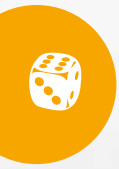

ZÄHLE DIE LECKEREN KEKSE!
COUNT THE TASTY COOKIES!



22614

COOKIE DOO

Die Geburtstagsfeier geht bald los und die Kekse müssen vorbereitet werden! Wer sammelt als erstes 10 farbenfrohe Kekse auf seinem Blech? Die Zahlenfolge 1 bis 10 sowie erstes Subtrahieren und Addieren werden geübt und verschiedene Spielvarianten als Memo sowie zum Frei- und Rollenspiel sind ebenso möglich.

The birthday party is going to start soon, and the cookie trays need to be prepared! Who will be the first in the kitchen to collect 10 colourful cookies on their tray? This is a funny game which engages kids with its colourful illustrations and offers a playful way to practice first counting. The aim of the game is to fill your cookie tray first by practising counting from 1 to 10 as well as basic additions and subtractions. Cookie Doo can also be played as a memo game and used for free play and role play.

Boxgröße | Box size: 120 × 120 × 510 mm



SCAN ME
Kids Video

XL

IDEAL FÜR DEN KINDERGARTEN:
BESONDERS ROBUST & ABWASCHBAR
IDEAL FOR KINDERGARTEN:
ROBUST AND WASHABLE BY HAND

ZAHLENFOLGE 1 – 10
COUNTING FROM 1 TO 10

ERSTES ADDIEREN & SUBTRAHIEREN
BASIC ADDITIONS AND SUBTRACTIONS



ROBUSTE XL
SPIELMATTE AUS
TEXTIL & GUMMI!
ROBUST XL MAT –
MADE OF RUBBER
AND TEXTILE!

30 KEKSE AUS HOLZ
30 WOODEN COOKIES

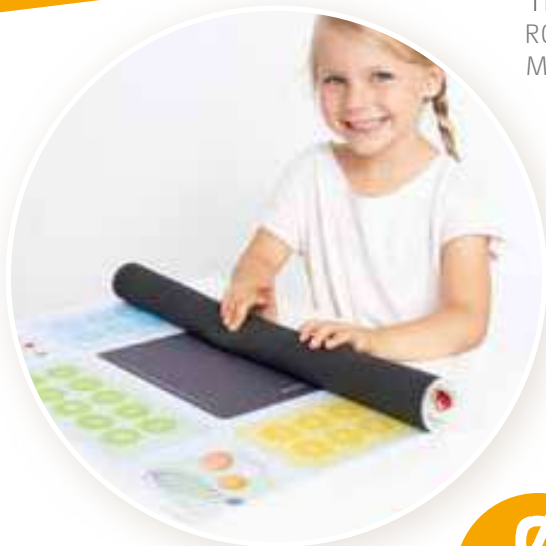

500 MM

500 MM



Ø
100 MM



MIT DREHSCHLEIBE
AUS HOLZ
WITH WOODEN
TURNABLE





BETTY FLY



22463

BETTY FLY

Alle bunten Schmetterlinge fliegen wild in der Luft herum. Jetzt heißt es schnell die richtigen Schmetterlinge einzusammeln! Wer wird wohl am Schnellsten sein? Hier sind Konzentration und eine schnelle Reaktion gefragt. Das spannende Schmetterlingsspiel fördert die Beobachtungsgabe und das Erkennen von Farbkombinationen.

All the colourful butterflies are flying around and chaos ensues. You have to be quick to catch the right butterfly. Who will be the first to catch it? Concentration & quick reaction are needed here. This exciting game of butterflies promotes observational skills and colour combination recognition.

Boxgröße | Box size: 120 x 120 x 460 mm



FINDE SCHNELL DIE RICHTIGEN SCHMETTERLINGS!
FIND THE RIGHT BUTTERFLIES QUICKLY!

Ø
450 MM



41 BUNTE
SCHMETTERLINGS
AUS HOLZ
41 WOODEN
BUTTERFLIES

SPIELIDEE DES KLASSIKERS „CANDY“
GAME IDEA LIKE BELEDUC
BESTSELLER „CANDY“

ROBUSTE XL SPIELMATTE
ROBUST XL MAT

41 BUNTE SCHMETTERLINGS AUS HOLZ
41 WOODEN BUTTERFLIES



XL SPIELMATTE AUS
TEXTIL & GUMMI
ROBUST XL MAT – MADE
OF RUBBER & TEXTILE



SCAN ME
Kids Video





EDUCATION NEXT!

EINE ANDERE ART VON MEMO UND DOMINO A DIFFERENT KIND OF MEMO AND DOMINO

Neue pädagogische Mathematik-Serie, bestehend aus 3 innovativen Spielen, wurde in Kooperation mit Dr. Gerhard Friedrich und Lara und Felix Friedrich-Schiefer entwickelt. Hier wird die frühe mathematische Bildung spielerisch umgesetzt.

A new educational mathematics series, consisting of 3 innovative games, was developed in cooperation with Dr. Gerhard Friedrich and Lara and Felix Friedrich-Schiefer. Here, early mathematical education is implemented in a playful way.

Dr. habil. Gerhard Friedrich ist Diplom-Pädagoge und unterrichtet als Lehrer die Fächer Mathematik, Technik, Pädagogik und Psychologie. Er ist Privatdozent für Allgemeine Didaktik an der Universität Bielefeld

Dr. habil. Gerhard Friedrich is a diploma pedagogue and teacher of mathematics, technology, pedagogic and psychology. He is a private tutor for general didactics at the university of Bielefeld as well as an author of books and games.



Lara Schiefer ist staatlich anerkannte Sozialpädagogin B.A. und war zuletzt in ihrem Ausbildungsberuf als staatlich anerkannte Erzieherin in einer Kleinkindertagesstätte tätig. Darüber hinaus ist sie Spieleautorin.

Lara Schiefer is a certified social pedagogue B.A. and recently worked as a state-certified educator in an early childhood nursery. She is also an author of games.

Felix Friedrich-Schiefer ist Diplom-Pädagoge, Studienrat und Spieleautor. Er unterrichtet an einer Berufsfachschule für Erzieher in den Fächern Pädagogik, Psychologie und Gerontologie.

Felix Friedrich-Schiefer is diploma pedagogue, head teacher and an author of games. He teaches at a professional school for nursery in the subject pedagogy, psychology and gerontology.



„KOMMT, LASST UNS
MATHE SPIELEN!“

„COME ON, LET'S
PLAY MATHS!“



2



**INNOVATIV
UND NEU!**
**INNOVATIVE
AND NEW!**



8

NEUE SPIELE LINIE “MATHEMATIK” NEW GAMES LINE “MATHEMATICS”

Klassische Memo- und Domino Spiele machen große Freude, sie trainieren das Gedächtnis der Kinder und fördern zusätzlich deren Sprachentwicklung. MEMOnext und DOMInext können aber deutlich mehr. Sie wurden auf der Grundlage aktueller wissenschaftlicher Erkenntnisse zum Zahlbegriffserwerb entwickelt und fördern darüber hinaus zentrale Basiskompetenzen, welche entscheidend für den späteren schulischen Erfolg sind. Außerdem werden wichtige Kern-Kompetenzen für Kinder im 21. Jahrhundert trainiert.

Aktiv-entdeckendes Lernen zur Förderung mathematischer Lernneugierde

Erkennen von Mustern, Regeln, Symbolen und Zusammenhängen

Entwicklung von Mengenvorstellungen und Verhältnissen, erkennen von Ziffern

Aufbau eines sicheren Zahlengrundverständnisses und erster Rechenoperationen im Zahlenraum von 1 bis 10

Interesse und Freude, gemeinsam über Dinge oder Probleme nachzudenken

Systematisieren und Dokumentieren von Beobachtungen

Entwicklung neuer Argumentationsfähigkeiten und sozial verträgliche Konfliktlösestrategien, Problemlösung durch Kommunikation

Classic memo and domino games are great fun, they train children's brains and also promote their language development. MEMOnext and DOMInext can do much more. They were developed on the basis of current scientific studies on the acquisition of number concepts and also promote central basic skills that are essential for later success at school. Important core competences for children in the 21st century are trained.

Active-discovery learning to promote mathematical learning curiosity

Recognition of patterns, rules, symbols and connections

Development of quantity concepts and ratios, recognition of numbers

Developing a basic understanding of numbers and first mathematical operations in the number range from 1 to 10

Interest and fun in thinking together about things or problems

Systematising and documenting observations

Developing of new argumentation skills and of socially acceptable conflict resolution strategies, problem solving through communication

3

9

Simultane Anzahlerfassung meint die Fähigkeit, die Anzahl einer unstrukturierten Menge auf einen Blick bestimmen zu können, ohne die Menge auszählen zu müssen. Diese Fähigkeit, die sich bei den meisten Kindern schon im Kindergartenalter zeigt, ist grundlegend für das Verständnis der Beziehung zwischen Zahlen und Mengen.

Simultaneous number recognition means the ability to determine the number of an unstructured quantity at a glance without having to count the quantity. This ability, which is already evident in most children at kindergarten age, is fundamental for understanding the relationship between numbers and quantities.



MEMOnext



XL

22616

MEMOnext »NATUR«

Wer entdeckt zu jeder Zahl ein Bild mit der passenden Menge? Das spannende Memo-Spiel funktioniert ähnlich wie ein klassisches Memo-Spiel. Das Besondere dabei ist, dass es mehrere Möglichkeiten gibt, die gezeigte Anzahl auf dem Bild zu deuten. Eine Bildkarte kann zu mehreren Zahlenkarten passen. Welche Bilder sehen die Kinder? Welche Mengen verstecken sich? Das Ziel des Spiels ist es, möglichst viele eigene Karten zu sammeln und gemeinsam alle Zahlen auf dem Zahlenweg abzudecken.

MEMOnext »NATURE«

Who can find a picture with the right quantity for each number? The exciting game is similar to a classic memo game. The special thing about it is that there are several ways to explain the number which is shown on the picture. One picture card can match to several number cards. What do the children see in the pictures? Which quantities are hidden? The idea of the game is to collect as many cards as possible and work together to find all the numbers and cover them on the number path.

Boxgröße | Box size: 250 x 200 x 65 mm



FÖRDT GRUNDLEGENDE MATHEMATISCHE & SPRACHLICHE KOMPETENZEN
PROMOTES BASIC LANGUAGE AND MATHEMATICAL SKILLS

ENTWICKELT MIT GERHARD FRIEDRICH,
PROFESSOR DER MATHEMATIK
DEVELOPED WITH GERHARD FRIEDRICH,
PROFESSOR OF MATHEMATICS



WOW!
XL Größe und
komplett aus Holz
XL size and
completely made
of wood

30 HOLZ-KARTEN:
20 MOTIVE, 10 ZAHLEN
30 WOODEN CARDS:
20 MOTIVES, 10 NUMBERS



80 MM
70 MM

4 hellbraune Eichhörnchen,
2 dunkelbraune Eichhörnchen,
6 Eichhörnchen, 2 Äste
4 light brown squirrels,
2 dark brown squirrels,
6 squirrels, 2 branches



UNBEDINGT ANSCHAUEN! | HAVE A LOOK!
Kids Video

MEHRERE ZAHLEN
VERSTECKEN SICH IN EINEM BILD
SEVERAL NUMBERS
ARE HIDING IN ONE PICTURE



XL

22617

DOMInext »OBST & GEMÜSE«

DOMInext ist ein Domino-Spiel für 2-4 Spieler. Ziel des Spiels ist es, alle Karten richtig anzulegen. Auf jeder Karte ist links eine Ziffer und rechts ein Bildmotiv abgebildet, indem sich mehrere Mengen verstecken können. Jedes Bildmotiv kann in Bezug auf die abgebildeten Mengen anders gedeutet werden. Es hängt vom Spieler ab, welche Zahlen er findet und wie er diese begründet. Stimmen Menge und Zahl überein, darf die Karte angelegt werden. Beispiel: 6 Eier in einer Schachtel; 1 braunes Ei und 5 weiße Eier.

DOMInext »FRUITS & VEGETABLES«

DOMInext is a domino game for 2-4 players. The goal of the game is to place all the cards correctly. Each card has a number on the left and a picture on the right in which several quantities can be hidden. Each picture can be seen in a different way in relation to the quantities. It depends on the players which numbers they find and how they explain them. If the quantity and the number match, the card can be put on. For example: 6 eggs in the box, 1 brown egg and 5 white eggs

Boxgröße | Box size: 250 x 200 x 65 mm



DOMInext

MENGENVERSTÄNDNIS (SIMULTAN) UND ERFASSUNG VON ZAHLEN WERDEN GESCHULT
UNDERSTANDING OF QUANTITIES (SIMULTANEOUS) AND COMPREHENSION OF NUMBERS IS TRAINED



Hier passen die Zahlen 1, 5 or 6 match | Here the numbers 1, 5 or 6 match



Cherry-Tomate/Basilikum
cherry tomato/basil



Ei | egg (1/5/6)



Zitrone | lemon



Paprika | paprica



MEHRERE ZAHLEN VERSTECKEN SICH IN EINEM BILD

SEVERAL NUMBERS ARE HIDING IN ONE PICTURE

WOW!
XL Größe und komplett aus Holz
XL size and completely made of wood



5 Erbsen außerhalb der Hülse | 5 peas outside the sleeve
4 Erbsen in der Hülse | 4 peas in the sleeve
1 Hülse/Schale | 1 sleeve
9 Erbsen gesamt | 9 peas



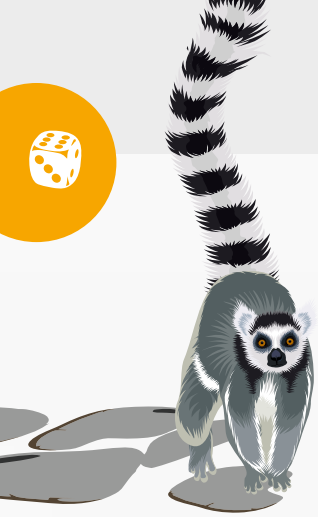

JOE'S ZOO

Zähle und füttere die Tiere!
Count and feed the animals!



ZÄHLEN VON 1-10
COUNTING FROM 1-10

ERSTES ERKENNEN
VON MENGEN
FIRST RECOGNITION
OF QUANTITIES

FÖRDERT MATHEMATISCHE & SPRACHLICHE
KOMPETENZEN
PROMOTES MATHEMATICAL AND LINGUISTIC
COMPETENCES



22618

JOE'S ZOO

Jede Menge Spaß im Artenschutz-Zoo! Aus der ganzen Welt kommen Besucher, um die Tiere zu bestaunen. Natürlich gibt es jede Menge Arbeit, die Joe erledigen muss: Er muss die Tiere füttern und die Wegplatten wieder neu ordnen, damit die Menschen seinen Artenschutz-Zoo besuchen können. Sein Dackel DapDap ist immer mit dabei. Ziel des Spiels ist es, die Tiere zu füttern oder alle Wegplatten zu ordnen. Was gelingt als erstes? Ein kooperatives Spiel, das für ganz viel Spaß sorgt und zusätzlich viele Informationen zu spannenden Tierarten bietet.

Lots of fun at the species protection zoo! Visitors come from all over the world to see the animals. Of course there is a lot of work that Joe has to do: He has to feed the animals and re-arrange the path tiles so that people can visit his species protection zoo. His dog DapDap is always on his side. The aim of the game is to feed the animals or to re-arrange all the path tiles. Which task is successfully completed first? A cooperative game that ensures a lot of fun and also offers a lot of information about interesting animal species.

Boxgröße | Box size: 385 x 385 x 60 mm



10 WEGPLATTEN (ZAHLEN 1-10)
10 PATH PLATES (NUMBERS 1-10)



KOOPERATIVES SPIEL
COOPERATIVE GAME

55 FUTTERSTÄBE AUS HOLZ
55 WOODEN FOOD STICKS



27 SPIEL-KARTEN
27 GAME CARDS

HILF JOE SEINE TIERE
ZU FÜTTERN!
HELP JOE TO FEED
HIS ANIMALS!



Zoos übernehmen im Artenschutz eine zentrale Aufgabe. Sie widmen sich dem Schutz bedrohter Lebensräume und gleichzeitig der Erhaltungszucht bedrohter Arten. Zoos play a central role in species conservation. They are committed to the protection of threatened habitats and at the same time to the conservation of endangered species.



ZUSATZMATERIAL
ZUM DOWNLOAD
ADDITIONAL MATERIAL
FOR DOWNLOAD
WWW.BELEDUC.DE



375 MM



Änderungen vorbehalten. | Changes reserved.





MARBELINO 1

"SORTING"

SORTIERE GRÖSSE UND FARBEN
SORTING SIZES AND COLOURS



Ø 25 cm

30x
Ø 2 cm

18x
Ø 3 cm

10 KARTEN MIT
3 SCHWIERIGKEITSSTUFEN
10 CARDS WITH
3 DIFFICULTY LEVELS

ALS EINZEL- ODER
GRUPPENSPIEL (1-4 SPIELER)
AS SINGLE PLAYER OR GROUP
ACTIVITY (1-4 PLAYERS)

MIT AUFBEWAHRUNGSBEUTEL
FÜR DIE HOLZKUGELN
WITH COTTON BAG FOR THE
WOODEN MARBLES



21022

MARBELINO 1 „SORTING“

An die Kugeln, fertig, los! Bei diesem Sortierspiel gibt es die Möglichkeit alleine oder mit anderen gemeinsam zu spielen. Es gibt Kugeln in zwei verschiedenen Größen und eine Zange, die für beide Größen passt. Mit den Aufgabenkarten können Kinder lernen, die unterschiedlichen Größen, Mengen und Farben der Kugeln zu erkennen. Um die Feinmotorik zu trainieren, legen die Kinder die Kugeln mit der Holzzange in die Vertiefungen. Kinder können die Aufgabenkarten nutzen, das Würfelspiel oder frei und kreativ spielen.

Marbles ready, set, go! The sorting game proposes some sorting activities with coloured balls in 2 different sizes and can be also played as a dice game. It also trains fine motor skills when using the tongs suitable for both ball sizes. The wooden board has 6 circular slots identified by white areas inside, and by outer circles in 6 different colours. Kids can use the activity cards, play the dice game, or also use their creativity and do free play.

Boxgröße | Box size: 320 x 310 x 110 mm



SPIELBRETT UND
KUGELN AUS HOLZ
WOODEN GAME
BOARD AND BALLS

AUCH ALS WÜRFEL-
SPIEL SPIELBAR!
ALSO PLAYABLE AS
DICE GAME!



SCAN ME
Kids Video



MARBELINO 2

"PATTERN"



21023

MARBELINO 2 „PATTERN“

Dieses Sortierspiel mit vielen bunten Kugeln beinhaltet verschiedene Aufgaben mit unterschiedlichen Schwierigkeitsstufen zum Thema „Reihenfolgen und Muster“. Kinder können die unterschiedlichen Aufgaben lösen oder selbst kreative Muster legen. Alle Aufgaben können auch als Kommunikationsspiel gespielt werden, indem sich die Kinder gegenseitig die Aufgaben beschreiben. Das Holz-Spielbrett hat einen inneren und äußeren Bereich, der jeweils entweder für Muster- oder für Reihenfolgen-Aufgaben genutzt werden kann.

The pattern game allows kids to do many different activities with the coloured balls, mainly playing with sequences and patterns. Children can solve different tasks shown on the included cards or use their creativity during free play. All the activities can be played also as a communication game, where one player describes the card to another, who has to follow the instructions and put the balls in the right place. The wooden board has an inner and an outer part which can be used to do pattern and sequence activities.

Boxgröße | Box size: 270 x 260 x 100 mm

LEGE LOGISCHE MUSTER UND REIHEN
FOLLOW LOGICAL PATTERNS AND SEQUENCES



SCAN ME
Kids Video



Ø 25 cm

64x
Ø 2cm



BEST
SELLER



Federica Monzio Compagnoni

Spielzeugdesignerin und Spieleautorin, Italien
Toy and game designer, Italy

„Die Marbelino-Serie mit ihren bunten Kugeln und strukturierten Tafeln führt die Kinder auf spielerische Weise an das erste logische und mathematische Denken heran. Dank ihres einfachen und flexiblen Aufbaus sind die Marbelino-Spiele nicht nur lustig, sondern auch pädagogische Hilfsmittel, die Erzieher an ihre Bedürfnisse anpassen und auf vielfältige Weise einsetzen können, um die Entwicklung der Kinder zu fördern.“

“The Marbelino series, with its colourful balls and organized boards, introduces children to the first logical and mathematical thinking, in a playful way. Thanks to their simple and flexible configuration the Marbelino items are not only fun to play, but educational tools teachers can adapt to their needs and use in multiple ways, following kids’ development.”



20 AUFGABENKARTEN –
LÖSUNG AUF DER RÜCKSEITE
INCLUDING 20 TASK CARDS –
SOLUTION PRINTED ON
THE BACK



IDEAL AUCH FÜR VORSCHULE/
GRUNDSCHULE
ALSO IDEAL FOR PRESCHOOLS
AND PRIMARY SCHOOLS

HOLZSPIELBRETT UND
64 HOLZKUGELN MIT
AUFBEWAHRUNGSBEUTEL
WOODEN BOARD & 64 WOODEN
MARBLES WITH COTTON BAG





CLIMB

BALANCIER SPIEL
BALANCE GAME



XL

25582

CLIMB

Climb ist ein spannendes Geschicklichkeitsspiel, bei dem man allein oder mit Freunden die Kugeln mit Geschick und Feingefühl zur Spitze des Turms balanciert. Das Ziel des Spieles ist es, zuerst alle drei Kugeln mit Hilfe des Kugel-Lifters auf das obere Plateau zu befördern. Am besten ist es natürlich, wenn keine Kugel dabei herunterfällt oder durch eines der Labyrinth-Löcher verloren geht. Es gibt drei Hauptspielvarianten: Gruppenspiel mit bis zu 4 Spielern, kooperatives Gruppenspiel mit drei Kindern pro Gruppe, freies Balancieren unter Einbezug der Spielbasis (CLIMB Turm) allein oder in der Gruppe.

Climb is an exciting balancing game, where you have to balance the ball to the top of the tower either alone or as a team using finesse and dexterity. The aim of the game is to be the first player to guide all three balls of the same colour to the top plateau of the tower. Ideally no ball should fall down or get lost in the holes of the labyrinth on the way up. There are three main game variations: Group play with up to 4 players, cooperative group play with 3 children each per team or free play using the Climb Tower either alone or as a group.

Boxgröße | Box size: 410 × 400 × 425 mm

4+

2-6

21

FOB

!1



SCAN ME
Kids Video

MIT DEM KUGEL-LIFTER LASSEN SICH DIE KUGELN SICHER DURCH DAS LÖCHER-LABYRINTH STEuern
THE BALLS CAN BE SAFELY GUIDED THROUGH THE LABYRINTH WITH THE BALL-LIFTER

400 MM

Montiert geliefert
Delivery preassembled

EROBERE ALS ERSTER DEN CLIMB-TURM
BE THE FIRST TO CLIMB THE TOWER

16 KUGELN UND
4 KUGELLIFTER
16 BALLS AND
4 BALL-LIFTERS



DIE KUGELN LANDEN BESONDERS LEISE DURCH DEN INTEGRIERTEN FILZ-EINLEGER
THE BALLS WILL LAND QUIETLY DUE TO AN INTEGRATED FELT-INLAY

MASSIVE HOLZBAUTEILE
STURDY WOODEN GAME

VON VIER SEITEN BESPIELBAR
PLAYABLE ON ALL FOUR SIDES

3 MAGNETISCHE STARTFELDER
3 MAGNETIC STARTING POINTS





25581

XL

WOBBLING CITY

Ein spannendes Balancierspiel, bei dem du eine farbenfrohe Stadt allein oder zusammen mit deinen Freunden baust. Kannst du die wackelige Balancierscheibe während des Bauens im Gleichgewicht halten? Das Spielziel ist es, alle Häuser und Bäume auf der Scheibe zu positionieren, ohne dass etwas herunterfällt. Die beidseitig bedruckte Holzscheibe kann hierbei für verschiedene Spielmodalitäten sowie freies, kreatives Spielen genutzt werden.

Wobbling City is an amusing balance and skill game! Build the colourful city alone or with your friends. Will you manage to balance it on the wobbling plate? The aim of the game is to put all the houses and trees on the wobbling plate without making them fall. The gameboard is double-sided and it allows different game variations as well as free play.

Boxgröße | Box size: 460 × 465 × 100 mm



SCAN ME
Kids Video



420 MM

RÜCKSEITE | BACK



VORDERSEITE | FRONT



Ø
450 MM

33 HÄUSER & BÄUME AUS HOLZ
33 WOODEN HOUSES & TREES



XL BALANCIERSPIEL!
XL BALANCE GAME!

ALLE TEILE AUS HOLZ!
ALL PIECES MADE FROM WOOD!

TRAINIERT DIE FEINMOTORIK
TRAINS FINE MOTOR SKILLS

FREEPLAY

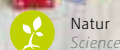
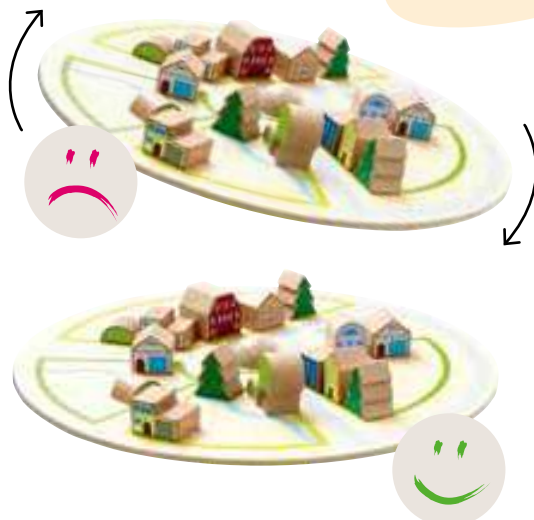

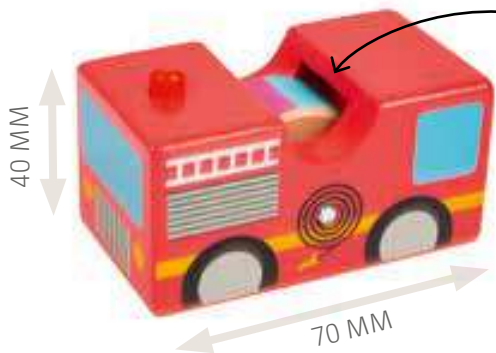

FEUERWEHRAUTO
AUS HOLZ – MIT DREH-
BAREM FARBRAD
WOODEN FIRETRUCK
– WITH A COLOURED
TURNING WHEEL

40 MM

70 MM



MIT 6
FEUER-FLAMMEN
AUS HOLZ
WITH 6 WOODEN
FLAMES



LERN- & INFOKARTE
LEARN- & INFOCARD

210 MM

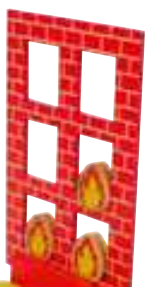

400 MM

400 MM



22890

FIRE ALARM

Hilfe das Hochhaus brennt! Zum Glück konnten alle Tiere und Menschen bereits in Sicherheit gebracht werden, aber ist das Haus noch zu retten? Das Team der Löschfreunde springt schnell ins Feuerwehrauto und macht sich auf den Weg zum Brand. Hoffentlich kommen sie rechtzeitig bevor das Haus vollständig abgebrannt ist!

Help – the building is on fire! Fortunately, all of the animals and people could be brought to safety, but can the building be saved? The firefighters have jumped into the fire engine and are on their way to the scene of the fire. Hopefully they will arrive before the building burns down!

Boxgröße | Box size: 378 × 275 × 65 mm



DAS DREHEN UND BEWEGEN DES AUTOS, SOWIE DAS PLATZIEREN DER FLAMMEN TRAINIERT DIE FEINMOTORIK
MOVING THE FIRE ENGINE AND PLACING THE FLAMES HELPS TO TRAIN FINE MOTOR SKILLS

KOOPERATIVES SPIEL ZUR FARBERKENNUNG
COOPERATIVE PLAY AND COLOUR RECOGNITION

LÖSCHT DEN BRAND GEMEINSAM!
EXTINGUISH THE FIRE TOGETHER!





SPLASH



22615

SPLASH

Die Tierfreunde der Arktis haben jede Menge Spaß und wollen alle mit einem Sprung ins Wasser zurück. Wer schafft das als Erster? Welcher Weg ist der Richtige? Nur wer gut beobachtet und konzentriert ist, kann gewinnen! „SPLASH – los geht es!“ Ein erstes Regelspiel für die Kleinsten. Es fördert spielerisch die Farbzuoordnung und Motorik.

The animal friends in the Arctic are having loads of fun playing and all want to jump back into the water with a huge splash. Who will be the first to jump? Which way is the quickest? Only the player who can observe and concentrate the best can win. A game with simple rules for the youngest players to train first colour recognition and fine motor skills. "SPLASH – Let's go!"

Boxgröße | Box size: 225 x 225 x 70 mm



IN PRAKTISCHER
AUFBEWAHRUNGSBOX
AUS HOLZ
IN PRACTICAL WOODEN
STORAGE BOX



20 TIERKARTEN, WÜRFEL,
STAB & EISSCHOLLE AUS HOLZ
20 WOODEN ANIMAL CARDS,
DICE, STICK & ICE FLOE



WER SPRINGT ALS ERSTER
INS WASSER?

BE THE FIRST TO JUMP
INTO THE WATER!



SPLASH!

225 MM





PUNAKAI



22860

PUNAKAI

Farbenfrohe Fische tummeln sich im bunten Korallenriff. Doch im weiten Meer lauern überall Gefahren, weshalb sich die Fische stets tarnen müssen – was am besten vor farblich gleichem Hintergrund funktioniert. Außerdem schwimmen die Fische immer im Schwarm und niemals allein. Wer schafft es zuerst, seine Fische passend abzulegen? 44 Fische aus Holz, bunt und hochwertig bedruckt

Bright fish swim around in the colourful coral reef. But there are dangers lurking everywhere in the vast ocean, which is why the fish always have to camouflage themselves. This works best against a background of the same colour. Additionally, the fish always swim in swarms and never alone. The first player to place all their fish correctly, wins the game! 44 wooden fish with colourful high-quality print

Boxgröße | Box size: 240 × 240 × 65 mm



DIE SPIELBOX IST TEIL DES SPIELS
BOX IS PART OF THE GAME!

DAS SPIEL FÖRdert VOR ALLEM DIE FARBKERNUNG & FEINMOTORIK
ESPECIALLY TRAINS COLOUR RECOGNITION AND FINE MOTOR SKILLS

ORDNE DIE FISCH
RICHTIG ZU!
MATCH THE FISH
CORRECTLY!



SCAN ME
Kids Video



240 MM

AUCH ALS XXL-SPIEL ERHÄLTICH (S. 96/97)
ALSO AVAILABLE AS XXL GAME (P. 96/97)



22800

CATCH THE NUMBER

Wer schafft es zuerst, genug Punkte zu sammeln, um das Rennen der Zahlen zu gewinnen? In diesem Spiel geht es darum als erster die Zielzahl zu sammeln. Hierbei sind Schnelligkeit und eine gute Auffassungsgabe gefragt. Doch Vorsicht, lasst euch eure Zahlen nicht von eurem Nachbarn abluhnen!

Who will be the first to collect enough points to win the numbers race? This game is all about being the first to collect the target number. Speed and good comprehension are needed, but be careful! Don't let your neighbour steal your numbers!

Boxgröße | Box size: 240 x 240 x 65 mm



4 SPIELPLÄNE INKLUSIVE
INCL. 4 GAME BOARDS



40 ZAHLEN AUS HOLZ
40 WOODEN NUMBERS

51 TEILE – 4 SPIEL-
PLÄNE INKLUSIVE
51 PIECES – INCL.
4 GAME BOARDS



KOMBINIERE DIE
RICHTIGEN ZAHLEN.
COMBINE THE RIGHT
NUMBERS.



SCAN ME
Kids Video



22390

BANDITTI

Warum liegt die Wurst im Schlafzimmer, der Schlüssel im Bad und das Geld in der Küche? Durch schlaue Fragen und logisches Kombinieren wird herausgefunden, wo die anderen Räuber ihre Beute versteckt haben. Denn nur, wer als Erster fünf Gegenstände der anderen Räuber ergaunern konnte, gewinnt das Spiel.

Why is the sausage in the bedroom, the key in the bathroom, and the money in the kitchen? Find out where the other robbers have hid their loot by asking clever questions and thinking logically. Because only the bandit who can steal five items from the other robbers wins the game.

Boxgröße | Box size: 378 x 275 x 65 mm



4 UNTERSCHIEDLICH
ILLUSTRIERTE HÄUSER
DIFFERENT ILLUSTRATIONS
IN EACH HOUSE



AUFGEPASST UND
RICHTIG KOMBINIERT!
PAY ATTENTION AND
COMBINE CLEVERLY!





SCHNELLES,
DYNAMISCHES
MERKSPIEL!
FAST, DYNAMIC
MEMO GAME!

10 HOLZCHIPS + 30 KARTEN
10 WOODEN-CHIPS + 30 CARDS

ZUSATZMATERIAL
ZUM DOWNLOAD
ADDITIONAL MATERIAL
FOR DOWNLOAD
WWW.BELEDUC.DE

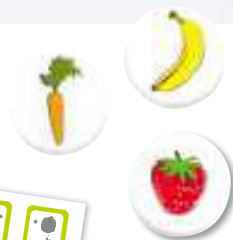

IN PRAKTISCHER AUFBE-
WAHRUNGSBOX AUS HOLZ
IN PRACTICAL WOODEN
STORAGE BOX



22613

MIAS'S GARDEN

Heute ist es endlich soweit! Mia, die kleine Erd-
beere, und ihre Obst- und Gemüsefreunde aus
dem Garten spielen mit euch Kindern verstecken.
Schon seit Tagen sind die Freunde ganz aufge-
regt, aber am allermeisten die kleine Mia und
sie ruft ganz schnell alle ihre Freunde zusam-
men. Seid ihr bereit? Dann kann es ja losgehen.
Wollen wir doch mal sehen, wer von euch am
schnellsten das gesuchte Obst oder Gemüse
entdeckt.

Today is finally the day! Mia the little straw-
berry and her fruit and vegetable friends leave
their garden to play hide and seek with all kids.
The friends have been very excited for days, especially
little Mia who quickly calls all her friends together.
Are you ready? Then let's get started. Let's see
which one of you will find the fruit or vegetable
you are looking for the quickest.

Boxgröße | Box size: 150 × 150 × 60 mm



SCAN ME
Kids Video



DIE SCHEIBEN SIND
DREHBAR
THE DISCS ARE
TURNABLE



25 KARTEN MIT LUSTIGEN
AKROBATISCHEN TIER-KUNSTSTÜCKEN
25 CARDS WITH FUNNY AND
ACROBATICAL ANIMAL TRICKS



WELCHES TIER
TURNT MIT WEM?
WHO'S DOING
GYMNASTICS WITH
WHOM?



22870

ACROBATICO

Hier tanzt die Maus dem Bären auf der Nase
rum! Vorhang auf für die tierischen Akrobaten:
Es wurde lange trainiert, doch vor Aufregung
rennen alle Tiere wie wild umher. Könnt ihr im
großen Durcheinander helfen, damit jeder seinen
Partner findet? Dann heißt es wieder: Manege frei
für bärenstarke Kunststücke!

You'll find the mouse dancing on the bear's nose
here! Raise the curtain for the animal acrobats:
They have been training for a long time, but all
the animals are running around like crazy with
excitement. Can you help everyone find their
partner amongst all the chaos? The time has
come: Clear the ring for bear-y impressive tricks!

Boxgröße | Box size: 320 × 225 × 45 mm





22900

EL GECKO

Der kleine Gecko Georg und seine Freunde wollen in der Mittagssonne ein Schläfchen machen. Dabei möchte jeder eine der begehrten Positionen auf dem kippeligen Felsen ergattern. Damit jeder ein Plätzchen findet, müssen alle ihr Gleichgewicht halten und dürfen nicht herunterfallen!

The small gecko George and his friends want to take a nap in the midday sun. In order to do so, they need to grab one of the popular spots on the precarious rock. To ensure that they can all find a spot, they need to stay balanced and mustn't fall off!

Boxgröße | Box size: 315 x 225 x 40 mm

4+



FOB



VIELE VERSCHIEDENE SPIEL-VARIANTEN – UNTERSCHIEDLICHE SCHWIERIGKEITEN
MANY DIFFERENT VARIATIONS – DIFFERENT LEVELS OF DIFFICULTY



SCAN ME
Kids Video



22830

FLOPPING

Fledermäuse wirbeln durch die Luft, um einen Platz in den zwölf Räumen der Burg zu finden. Mithilfe des Katapults können die unterschiedlichen Zimmer angesteuert werden, sodass jede Fledermaus ein lauschiges Plätzchen finden kann. Wer am Ende des Spiels mehr Räume erobern konnte, gewinnt das Spiel!

Bats flutter through the air to find a spot in the twelve rooms of the fortress. Different rooms can be targeted using the catapult so each bat can find a cosy spot. Whoever conquers the most rooms by the end of the game wins!

Boxgröße | Box size: 378 x 275 x 65 mm

4+



FOB



Übt feinmotorische Fertigkeiten beim Zielen mit Hilfe des Katapults.
Practice fine motor skills by aiming with the catapult.



Fledermäuse wirbeln durch die Luft.
Bats flutter through the air.

LASS DIE FLEDERMÄUSE FLIEGEN!
LET THE BATS FLY!



STAPELT DIE BUNTEN ECHSEN!
STACK THE COLOURFUL GECKOS!



FUN PARK



22612

FUN PARK

Die kleinen Parkbesucher haben einen aufregenden Tag vor sich. Mit der kleinen bunten Bimmelbahn, die fröhlich ihre Runden dreht, möchten sie den Park erkunden. Hier ist Merkfähigkeit gefragt! Denn nur wer den Überblick behält, kann den Kindern dabei helfen an ihren Lieblings-Ständen und -Attraktionen auszusteigen und genug Gewinnerplättchen für sich selbst sammeln.

The park's young visitors have an exciting day ahead of them. They want to explore the park aboard the small, colourful train. To win the game, you will need to pay close attention! The aim is to collect enough tiles to win the game by helping the children to disembark at their favourite booths and attractions.

Boxgröße | Box size: 385 × 385 × 60 mm



REISE DURCH DEN VERGNÜGUNGSPARK!
A TRIP THROUGH THE AMUSEMENT PARK!

FEINMOTORISCHE FÄHIGKEIT
BEIM DREHEN DES HOLZRINGES
FINE MOTOR SKILLS WHEN
TURNING THE WOODEN RING

ALLE TEILE AUS HOLZ!
ALL PARTS MADE FROM WOOD!

12 CHIPS & 20 SPIEL-PLÄTTCHEN!
12 CHIPS & 20 GAME TILES!

TIPP!



Ø
370 MM

DIE SPIELFLÄCHE
IST DREHBAR
THE GAME BOARD
IS ROTATABLE



SCAN ME
Kids Video



FAIRY LAND



22611

FAIRY LAND

Die kleinen Zauberelfen leben versteckt in tiefen Wäldern und weiten Wiesen. Kein Mensch bekommt sie je zu Gesicht. Doch hin und wieder kann man sie hören, wenn man konzentriert lauscht. Ist hier und dort ein leises Kichern und in regelmäßigen Abständen ein dumpfes „Plopp“ zu hören, dann spielen sie wahrscheinlich ihr Lieblingsspiel und lassen bunte Zauberbälle hüpfen und verschwinden. Doch nur der glückliche Elf, der seine Bälle bis zum Schluss behält, gewinnt das Spiel.

The little magic elves live hidden in deep forests and wide meadows. No one ever gets to see them. But now and then, you can hear them if you listen carefully. If there is a quiet giggle here and there and a muffled “plopp” can be heard at regular intervals, they are probably playing their favourite game, bouncing colourful magic balls and making them disappear. But only the lucky elf who keeps his balls until the end wins the game.

Boxgröße | Box size: 310 × 310 × 65 mm



HIER WIRD DIE SPIELBOX GENUTZT!
USE THE GAME BOX FOR PLAYING!

FÖRdert SPIELÜBERSICHT UND STRATEGISCHES SPIELEN
TRAINS GAME OVERVIEW AND STRATEGIC PLAYING

ZAUBERE DIE BUNTEN BÄLLE WEG!
LET'S PLAY MAGIC!



20 SOFTBÄLLE
+ 38 KARTEN!
20 SOFTBALLS
+ 38 CARDS!

310 MM



((PLOPP))



Karin Hetling

Spieleautorin & Förderschullehrerin, Deutschland
Game author & special education teacher, Germany

„Darf ich einmal einen Ball herunterdrücken?“ wurde ich von einem Kind gefragt, als wir gerade zu einer Testrunde „Fairyland“ in einem Café saßen. Klar durfte das Kind auch mal drücken und spielte gleich eine Runde mit. Und mir zeigte sich, wie hoch der Aufforderungscharakter bei dem Spiel ist! Der größte Spaß ist es, die Softbälle verschwinden zu lassen! Und ganz nebenbei wird noch Feinmotorik, Farbkenntnis und mathematisches Denken gefördert, so dass ich Fairyland sehr gerne in meiner Schule einsetze.

“Can I press down a ball once?” I was asked by a child when we were sitting in a cafe for a test round of “Fairyland”. Of course the child was allowed to press down and played a round with me. And it showed me how high the animating character is in the game! It is the greatest fun to make the softballs hide! And by the way, it promotes fine motor skills, color knowledge and mathematical thinking, so I love using Fairyland in my school.



SCAN ME
Kids Video





**AUF DIE PALME,
FERTIG, LOS!**
**ON THE PALM TREE,
READY GO!**

**3D-AUFBAU
3D-SETUP**

**ALLE TEILE AUS HOLZ GEFERTIGT
ALL GAME PARTS MADE OF WOOD**
**FÖRDERT FEINMOTORIK UND
FARBERKENNUNG
TRAINS FINE MOTOR SKILLS
AND COLOUR RECOGNITION**



**4 SÜSSE AFFEN UND 8 CLIPS
4 CUTE MONKEYS AND 8 CLIPS**



22400

MONKEY RALLYE

Die Affen haben Lust auf ein kleines Wettrennen: Alle starten gleichzeitig und versuchen jeweils ihre Palme als Erster zu erklimmen. Entscheidet den nächsten Spielzug mit Bedacht, denn es kann immer sein, dass der Affe auf dem Weg zu den Palmenblättern wieder ein Stückchen nach unten rutscht! Welcher Affe erreicht die versteckten Kokosnüsse am Schnellsten?

The monkeys want to run a short race: All of them start out at the same time and try to be the first one to climb their palm tree. Choose your next move carefully, because there's always a possibility that the monkey slips down a bit on his way to the palm leaves! Which monkey is the fastest to reach the hidden coconuts?

Boxgröße | Box size: 385 x 385 x 60 mm



MIT DREHBARER SPIELFLÄCHE | WITH ROTATABLE GAME BOARD
360°



**GROSSES MASSIVES HOLZSPIEL
LARGE, STURDY WOODEN GAME**

**MATCH! FARBE
VON FELD & KARTE
STIMMEN ÜBEREIN
MATCH! COLOUR
IN THE HOLE AND
ON THE CARD IS
MATCHING.**



**4 FIGUREN UND
1 WÜRFEL AUS HOLZ
4 FIGURES AND 1 DICE
MADE FROM WOOD**



22600

LITTLE VILLAGE

Wer lockt die kleinen Nager mit viel Käse, Geschick und der richtigen Taktik aus Ihrem Versteck? Die Ratten müssen raus aus der Stadt und so zieht jeder Rattenfänger los. Doch auch die Katze schleicht durch die Stadt und die Ratten suchen sich neuen Unterschlupf! Wenn man sich schon fast am Ziel wähnt, kann es sein, dass die Ratten ihre Position ändern oder eine Katze kommt und einige Ratten zurück in die Stadt jagt. Nur wer alle Ratten einfängt, gewinnt das Spiel!

The rats have to leave the village, so every rat catcher sets out into the city to catch them. But just when you think you've almost achieved your goal, the rats might change their position, or a cat may come and chase some of the rats back into town. Only the player who can catch all the rats get them safely out of town will win the game.

Boxgröße | Box size: 385 x 385 x 60 mm





22701 | 22700

HEXENKÜCHE | HAPPY MAGIC

Die kleinen Hexenküchenmeister suchen unter den Pilzen nach den gewürfelten Farbpunkten. Stimmen die Farbe unter dem Pilz und die Würfelfarbe überein, darf der Pilz in eigenen Kessel abgestellt werden. Derjenige, der seinen Hexenkessel zuerst mit 7 Fliegenpilzen füllen konnte, ist Hexenküchenmeister.

The little potion brewing experts search under mushrooms for dots in the same colour as the colour that comes up on the dice. If the colour under the mushroom is the same as that shown by the thrown dice, the player may put the mushroom into his or her own cauldron. The first player to fill his or her cauldron with 7 mushrooms is the champion potion brewer.

Boxgröße | Box size: 378 × 275 × 65 mm



DEUTSCHER TITEL
GERMAN TITLE

ENGLISCHER TITEL
ENGLISH TITLE



Findet die magischen Fliegenpilze!
Find the magic mushrooms!

28 hochwertige Holzpilze
28 high quality wooden mushrooms



22710



HAPPY FARM

Auf ihrem Weg über den Spielplan sammeln die Spieler Tiere ein und tauschen sie gegeneinander. Wer am Ende zwei Kühe hat, erhält den Traktor und gewinnt das Spiel.

On their way over the course the players collect animals and exchange them for others. Whoever has got two cows at the end receives the tractor and wins the game.

Boxgröße | Box size: 378 × 275 × 50 mm



WER TAUSCHT AM GESCHICKTESTEN SEINE TIERE EIN?

WHO SWAPS HIS ANIMALS CLEVEREST?



367 MM



SCAN ME
Kids Video





MIT ZWEI SCHWIERIGKEITSTUFEN
WITH TWO LEVELS OF DIFFICULTY



FANG SCHNELL
DIE MÄUSE EIN.
CATCH THE MICE QUICKLY.



22790

TEMPO TONI

In der Küche von Schloss Käseburg geht es rund. Toni, der Koch, hat vergessen, den Käse wieder in den Kühlschrank zu räumen und nun wimmelt es überall von kleinen Mäusen. Ihr müsst Toni helfen, damit die Mäuse nicht zu viel von dem leckeren Käse knabbern. Schiebt dafür euren Käse über den Spielplan und fangt die gesuchten Mäuse damit ein. Tempo Toni!

Things are getting a bit crazy at Castle Cheese. Toni, the chef, has forgotten to put the cheese back in the fridge and now the place is full of little mice, who really love to eat the cheese. Help Toni to scare away the mice so they won't nibble too much of the tasty cheese. Tempo Toni!

Boxgröße | Box size: 240 x 240 x 65 mm



KANNST DU DAS BILD
VERVOLLSTÄNDIGEN?
CAN YOU COMPLETE
THE PICTURE?

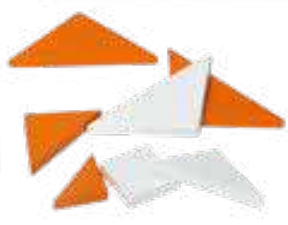

22571

LEGOLINO

Ein spannendes, kurzweiliges und interessantes Legepuzzle, das für ganz unterschiedliche Altersgruppen spielbar ist. Legolino beinhaltet 15 illustrierte Vorlagekarten, die unterschiedliche Schwierigkeitsgrade und somit Lernsteigerungen bieten.

An exciting, quick and interesting puzzle which is adaptable for different age groups. Legolino contains 15 illustrated template cards, which offer different difficulty levels, making learning advancements possible.

Boxgröße | Box size: 240 x 240 x 65 mm





22461

CANDY

Finde schnell das richtige Bonbon. „Greife zu“ und schnappe dir aus 41 verschiedenen Bonbons die richtige Farbkombination! Unser Farb-Spiel verbindet Merkfähigkeit und Reaktion mit ganz viel Spielspaß. Die Spieler würfeln mit drei Farbwürfeln. Je nach gewürfelter Farbkombination müssen sie so schnell wie möglich das dazu passende Bonbon finden. Drei unterschiedliche Spielvarianten legen fest, wer das Spiel gewinnt.

Find the right sweet quickly. Take your pick and find the right colour combination from 41 different sweets! Our colour game combines memory and reaction with lots of fun. The players throw three colour dice and need to quickly find the sweets that match the colour combination thrown. Three variations of playing determine the winner of the game.

Boxgröße | Box size: 240 × 240 × 65 mm



22481

RONDO VARIO

Kunterbunter Fädelspaß für die Kleinsten! Die Kinder müssen aus verschiedenen Holzformen in unterschiedlichen Farben die richtigen finden. Die zwei Würfel geben dabei die Kombination der Teile, die auf die Raupe gefädelt werden müssen, vor. Wer zuerst sechs Teile auffädeln konnte, gewinnt.

The children need to find the correct shape and colour among the wooden pieces. The two dice show the combination for the piece that needs to be threaded onto the caterpillar. Whoever gets six wooden pieces onto their caterpillar first wins.

Boxgröße | Box size: 240 × 240 × 65 mm



FINDE SCHNELL DIE RICHTIGEN BONBONS.

FIND THE RIGHT SWEETS QUICKLY.



KUNTERBUNTER FÄDELSPASS. COLOURFUL THREADING FUN.



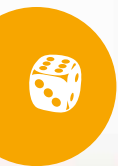

HOCHWERTIGE KORKPLATTE
HIGH-QUALITY CORK PLATES

INKL. MOTIV-VORLAGEN
INCL. MOTIF TEMPLATES

FÜR 2 KINDER GEEIGNET
SUITABLE FOR TWO CHILDREN



22380

MARTELLO

Mit Holzhammer und Nägeln werden die Formen auf die Korkplatten genagelt. Alle Teile können genauso einfach wieder entfernt werden. Eine Anleitung mit farbigen Beispielen hilft den Jüngsten und vereinfacht die ersten Versuche.

Use the wooden hammer and nails to affix the shapes to the cork plates. Removing all the pieces afterwards is just as easy. An instruction guide with coloured examples is included to help very young children try to make their first pictures.

Boxgröße | Box size: 240 × 240 × 65 mm



MIT ZAHLEN UND FORMEN | WITH NUMBERS AND SHAPES



22360

FISHING FEVER

Auf die Fische, fertig, los! Wer schafft es schneller die 3 Fische gleicher Farbe auf den Stab zu manövrieren? Oder stapelt so viele Fische wie möglich und schaut später auf der Fischunterseite, wer mehr Punkte ergattern konnte! Ein Angelspiel mit vielen Möglichkeiten!

To the fish, ready, go! Who can manage to move 3 fish of the same colour onto the rod faster? Or stack as many fish as you can and then later check the underside of the fish to see who got more points! A fishing game with lots of different ways to play!

Boxgröße | Box size: 400 × 120 × 120 mm



AUCH IN
XXL ERHÄLTICH
(S. 99)

ALSO AVAILABLE
IN XXL (P. 99)





22451

TORRETA

Nur wer geschickt den höchsten Turm baut, gewinnt das Spiel. Auch in Kombination mit Farb- und Zahlenwürfel spielbar. Die Kinder spielen mit dem Farb- oder Punktwürfel. Mit den gewürfelten Bausteinen werden Türme gebaut, aber nur wer geschickt stapelt und dabei den höchsten Turm baut, gewinnt das Spiel.

The children use either the dice with colours or the dice with dots. Depending on the colour or number of dots that come up when the dice is thrown, the children build towers and the winner is the player who stacks the bricks skilfully and produces the highest tower.

Boxgröße | Box size: 240 x 240 x 65 mm



SCAN ME
Kids Video



AUCH IN
XXL ERHÄLTlich
(S. 99)
ALSO AVAILABLE
IN XXL (P. 99)



LASS WACKELIGE
TÜRME WACHSEN.
LET WOBBLY
TOWERS GROW.



22471

SHAPY

Wer merkt sich die richtigen Formen? Die Spieler würfeln mit drei Formenwürfeln. Je nach gewürfelter Kombination der darauf abgebildeten Formen müssen sie so schnell wie möglich das entsprechende Plättchen finden. Unterschiedliche Varianten bieten viel Abwechslung.

The players throw three symbol dice. According to the combination of shapes shown on the dice, they need to quickly find the corresponding tile. Different variations of playing provide much variety.

Boxgröße | Box size: 240 x 240 x 65 mm



FINDE ALLE
RICHTIGEN FORMEN.
FIND ALL THE RIGHT
SHAPES.





PLATZ FÜR EINEN SCHATZ | SPACE FOR A TREASURE



22510

TROPICANO

Die kleinen Piraten möchten auf die Schatzinsel gelangen um den dort versteckten Schatz zu bergen. Schwimmen ist hier nicht möglich, da einige Haie im Meer lauern. Die Spieler würfeln reihum mit dem Symbolwürfel und bauen mit den gewürfelten Teilen nach und nach eine Brücke auf. Der Spieler, der zuerst eine vollständige Brücke zur kleinen Insel gebaut hat, darf sofort hinüberlaufen und den Schatz ausgraben.

The little pirates want to reach the island to dig up the treasure there. Swimming is not possible as sharks are lurking in the ocean. The players take turns to throw the symbol dice and gradually construct a bridge with the pieces thrown. The first player to finish building a complete bridge to the small island is allowed to cross it straight away and dig up the treasure.

Boxgröße | Box size: 385 × 385 × 80 mm



KOMPLETT AUS HOLZ
COMPLETELY FROM WOOD

345 MM



WO VERSTECKT SICH KATER MONTY?

WHERE IS MONTY THE CAT HIDING?



22411

FIND MONTY!

Wo versteckt sich Kater Monty? Ein Spiel für merkfähige Katerfinder, die immer genau wissen, wo sich der Kater zuletzt versteckt hat. Beschreibe Montys Versteck oder baue es mit Hilfe von Kissen, Decke und Bett nach! So wird nicht nur die räumliche Wahrnehmung, sondern auch die sprachliche Entwicklung gefördert.

A game for cat-finders with a good memory who always know where Monty the cat hid last. Describe his hiding place or reconstruct it using pillow, blanket and the bed! That way not only the spatial perception but also language development is supported.

Boxgröße | Box size: 240 × 240 × 65 mm



SCAN ME
Kids Video



22355

MECKI & CO.

Die Spieler füllen ihre Igel mit Stacheln, indem sie mit dem 3er oder 6er Würfel spielen. Der Spieler, dessen Igel als Erster alle 30 Stacheln auf seinem Rücken hat, gewinnt das Spiel.

The players are filling their hedgehogs with spines, by rolling the dice of 3 or 6 dots. The player, whose hedgehog is the first to have all 30 spines on his back, is the winner of the game.

Boxgröße | Box size: 385 × 385 × 60 mm

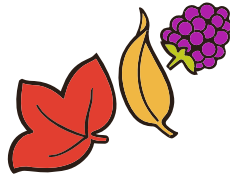

370 MM



22370

GOLDENER APFEL

Je nach gewürfelter Farbe bewegen die Spieler ihre Reiter über die bunten Felder zur Weide. Dort setzen sie sich auf die Pferde und reiten den Weg entlang zum „Goldenen Apfel“.

GOLDEN APPLE

According to the colour thrown, the players move their riders along the coloured fields to the meadow. There, they mount their horses and set off on the route along to the "Golden Apple".

Boxgröße | Box size: 385 × 385 × 60 mm





HOCHWERTIGER
HOLZRAHMEN
HIGH-QUALITY
WOODEN FRAME

265 MM



5 VORLAGEKARTEN:
BEIDSEITIG BEDRUCKT = 10 MOTIVE
5 TEMPLATE CARDS:
PRINTED ON BOTH SIDES = 10 MOTIFS



21120

FLEXIPAINTER

Die bunten Gummibänder geben Kindern die Möglichkeit besondere Kunstwerke entstehen zu lassen. Ob mit oder ohne Vorlagekarten – durch das Einspannen der Bänder werden feinmotorische Fertigkeiten trainiert und kreatives Gestalten gefördert.

The coloured rubber bands give children the opportunity to create special works of art. No matter whether these are with or without template cards – stretching the bands develops fine motor skills and promotes creative design.

Boxgröße | Box size: 285 × 270 × 30 mm



10 VORLAGEKARTEN
(BEIDSEITIG BEDRUCKT)
10 TASK CARDS
(PRINTED ON BOTH SIDES)

MAGNETSTIFT
MAGNETIC PEN

370 MM



21050

MAGNETSPIEL KUNTERBUNT

Mit dem Magnetspiel lassen sich durch die vielen verschiedenen bunten Steine tolle Bilder erschaffen. Beim Annähern mit dem magnetischen Stift werden die bunten Steine (5 Farben) angezogen und können zu kreativen Kunstwerken, wie Tiere, Autos und vieles mehr „kunterbunt“ zusammengestellt werden.

MAGNETBOARD BRIGHT COLOURS

With this magnetboard amazing pictures can be created with many different colourful plates. When the magnetic pen is close enough to the board, the plates (in 5 colours) can be picked up and moved across the board to design different creative works of art for example animals, cars, buildings and many more.

Boxgröße | Box size: 325 × 325 × 28 mm



SCAN ME
Kids Video



21040

MAGNETIC DRAWING BOARD

Lernen der Stifthaltung auf innovativste Weise! Metallkugeln lassen sich mithilfe des magnetischen Stifts zu tollen Bildern formen, die auch ganz schnell wieder weggewischt werden können.

Learn to hold a pen innovatively! Metal balls can be formed to cool pictures using the magnetic pen. Pictures can be removed easily again and again.

Produktgröße | Product size: 315 × 255 × 18 mm



21080

MAGNETIC DRAWING BOARD »LETTERS«

Buchstaben schreiben Lernen ohne Stift und Papier! Metallkugeln lassen sich mithilfe des magnetischen Stifts zu allen Großbuchstaben des Alphabets formen und zeigen Schreibanfängern so, auf welche Weise Buchstaben geschrieben werden.

Learning to write letters without pen and paper! Metall balls can be shaped into all upper case letters with the aid of the magnetic pen. This way write beginners can learn how letters are written.

Produktgröße | Product size: 315 × 255 × 10 mm



21090

MAGNETIC DRAWING BOARDS, 12 ER SET

Mit dem magischen Magnetboard lassen sich wie durch Zauberhand tolle Bilder erschaffen. Beim Annähern mit dem magnetischen Stift erscheinen die Kugeln sichtbar an der Oberfläche. Sie bleiben dort, bis ein neues Kunstwerk entstehen soll und die Kugeln dafür wieder mit Finger oder Stift zurück ins Board gedrückt werden.

SET OF 12 MAGNETIC DRAWING BOARDS

With the help of the magic pen, the hidden balls become visible and you can create beautiful works of art. For drawing new, creative pictures you can remove the balls by letting them disappear in the game board.

Produktgröße | Product size: 175 × 215 × 12 mm



21042
AUCH IN ROT ERHÄLTlich
ALSO AVAILABLE IN RED



LERNEN DER STIFTHALTUNG | LEARNING TO HOLD A PEN



22018
MAGNETSTIFT
MAGNETIC PEN



21090

MAGNETIC DRAWING BOARDS, 12 ER SET

Mit dem magischen Magnetboard lassen sich wie durch Zauberhand tolle Bilder erschaffen. Beim Annähern mit dem magnetischen Stift erscheinen die Kugeln sichtbar an der Oberfläche. Sie bleiben dort, bis ein neues Kunstwerk entstehen soll und die Kugeln dafür wieder mit Finger oder Stift zurück ins Board gedrückt werden.

SET OF 12 MAGNETIC DRAWING BOARDS

With the help of the magic pen, the hidden balls become visible and you can create beautiful works of art. For drawing new, creative pictures you can remove the balls by letting them disappear in the game board.

Produktgröße | Product size: 175 × 215 × 12 mm

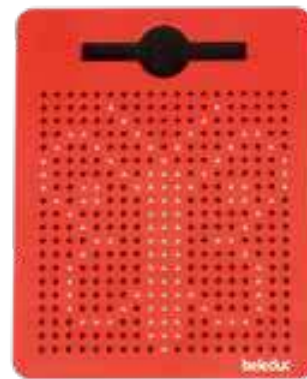

SCAN ME
Kids Video



AUCH EINZELN ERHÄLTlich
ALSO AVAILABLE SEPERATE

Vorlagekarten
zum Herunterladen unter
www.beleduc.de

Template Cards
to download on
www.beleduc.de

21091

MAGNETSPIEL, KLEIN MAGNETIC GAME, SMALL

Produktgröße | Product size: 175 × 215 × 12 mm





MIT MAGNETSTIFT
WITH MAGNETIC PEN



18 AUFGABENKARTEN
18 TASK CARDS

IN 3 SCHWIERIGKEITSSTUFEN
IN THREE DIFFICULTY LEVELS

LÖSUNGEN AUF DER RÜCKSEITE
SOLUTIONS ON THE BACK

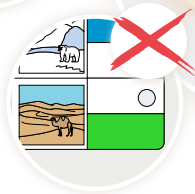

21070

LOGIPLAY

Logisches Kombinieren bedeutet Antworten auf die verschiedenen Aufgaben zu finden. Durch die Erklärung der Aufgabe auf jeder Karte wird schnell klar, wie die Aktivität gelöst wird und welche Kugeln ausgewählt werden müssen. Nachdem eine Aufgabenkarte gelöst wurde, wird die Karte umgedreht und das Kind kann seine Antworten selbst überprüfen.

Combining logically means to find answers for different tasks. By looking at the explanation on each card the child understands how to solve the problem and fills in the correct coloured ball. After finishing one task card the card will be turned over and the child can auto-check his answers.

Boxgröße | Box size: 320 × 225 × 45 mm



TIPP!

- 1 Vorlagekarte mit Motiv und Hintergrund
Task card with motif and background
- 2 Vorlagekarte mit weißen Flächen
Task card with white motifs
- 3 Vorlagekarte mit Punkteraster
Task card with dot matrix



21020

LOGIPIC

Jetzt wird es kreativ! LogiPic ist ein Magnetpiel zum Nachlegen verschiedener Vorlagekarten und zur Entfaltung der eigenen Phantasie. Seine handliche Größe eignet sich für Kinder und Erwachsene. Aufgrund der einfachen Handhabung ist das Produkt selbsterklärend und somit hervorragend zur selbstständigen Beschäftigung geeignet.

Now creativity starts! LogiPic is a magnet game with which different patterns on the task cards need to be copied on the board. Here phantasy can be unfolded to the fullest extent. The handy design makes the game suitable for both children and adults. Thanks to its easy use, the game is self-explanatory and perfectly suitable for independent play.

Boxgröße | Box size: 320 × 225 × 45 mm





LOGITURN



21021

LOGITURN

Drehe und ordne richtig zu. LogiTurn ist ein Zuordnungsspiel, das als Einzelspiel gedacht ist und viele Aufgaben aus verschiedenen Bildungsbereichen und Themen auf spielerische Art und Weise trainiert. Die Idee, die hinter LogiTurn steht, ist ein „analoges Tablet“, das es Kindern ermöglicht, verschiedene Aufgaben über einen „Bildschirm“ zu lösen, der nicht digital ist, aber dennoch ansprechend mit hohem Aufforderungscharakter. Das Spiel besteht aus dem Lösen der Aufgaben und dem Drehen kleiner Knöpfe. Ziel des Spiels ist es, die auf den Aktivitätskarten vorgeschlagenen Zuordnungen zu vervollständigen.

Turn and make the correct associations. LogiTurn is an association game for children from 4 years up, which proposes many activities from different educational areas and themes. They can be solved by one kid alone, or by several kids playing together. The idea that stands behind Logiturn is to have an "analogic tablet", which allows kids to do different tasks using a screen that is not digital, but still shows appealing and colourful pictures and amusing and educational activities. To solve the tasks, the children need to simply turn small knobs which promotes fine motor skills and trains hand-eye-coordination. The aim of the game is to complete the associations proposed on the activity cards.

Boxgröße | Box size: 320 × 225 × 45 mm



25 AUFGABENKARTEN
MIT SELBSTKONTROLLE
25 TASK CARDS
WITH SELF-CHECK

DIE AUFGABENKARTEN
SIND LEICHT ZU WECHSELN
TASK CARDS CAN BE
EASILY CHANGED

5 DREHBARE KNÖPFE
5 TURNABLE KNOBS



25 AUFGABENKARTEN MIT
2 SCHWIERIGKEITSLEVELS
25 TASK CARDS WITH
2 DIFFICULTY LEVEL

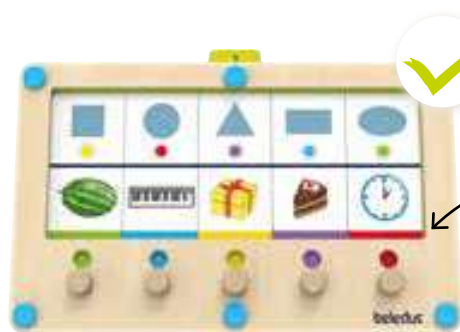
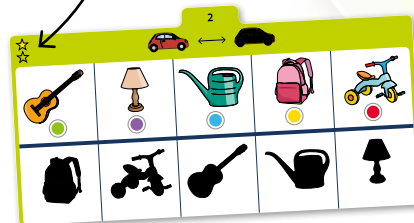
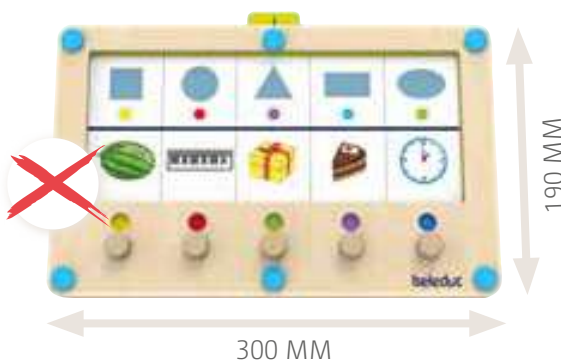

RÜCKSEITE MIT
FARBKENNZEICHNUNG
ZUR SELBSTKONTROLLE
BACKSIDE WITH
COLOURED AREA FOR
SELF CONTROL



SCAN ME
Kids Video



XXL PUNAKAI

LEGE DIE FISCHE PASSEND AN!
PLACE THE FISH CORRECTLY!

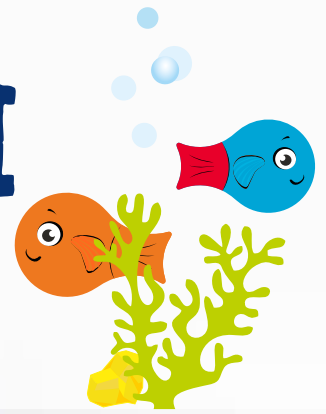

NEW!



Ø
800 MM

UNBEDINGT ANSCHAUEN! I HAVE A LOOK!

Kids Video



25583

XXL

XXL PUNAKAI

Viele bunte Fische sind im bunten Korallenriff. Doch im weiten Meer lauern überall Räuber, weshalb sich die Fische tarnen müssen, was am besten vor farblich gleichem Hintergrund funktioniert. Die Fische schwimmen immer im Schwarm und niemals alleine. Wer schafft es zuerst, seine Fische passend abzulegen?

The popular favourite now in XXL format! Colourful fish swim around in the colourful coral reef. But there are dangers lurking everywhere in the vast ocean, which is why the fish always have to camouflage themselves - which works best against a background of the same colour. In addition, the fish always swim in swarms and never alone.

Boxgröße | Box size: 820 x 125 x 125 mm

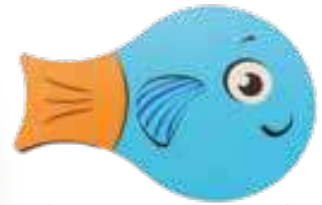

120 MM

DER BELIEBTE BESTSELLER IM XXL-FORMAT!
THE POPULAR BESTSELLER IN XXL FORMAT!



44 FARBENFROHE FISCH AUS HOLZ | 44 COLOURFUL FISH MADE OF WOOD

FARBEN ERKENNEN UND ZUORDNEN!
RECOGNISING AND MATCHING COLOURS!

MEHR ZUSATZMATERIAL ZUM DOWNLOAD
MORE ADDITIONAL MATERIAL FOR DOWNLOAD
www.beleduc.de

AUCH ALS DOMINO-VARIANTE SPIELBAR! | ALSO PLAYABLE AS DOMINO VARIANT

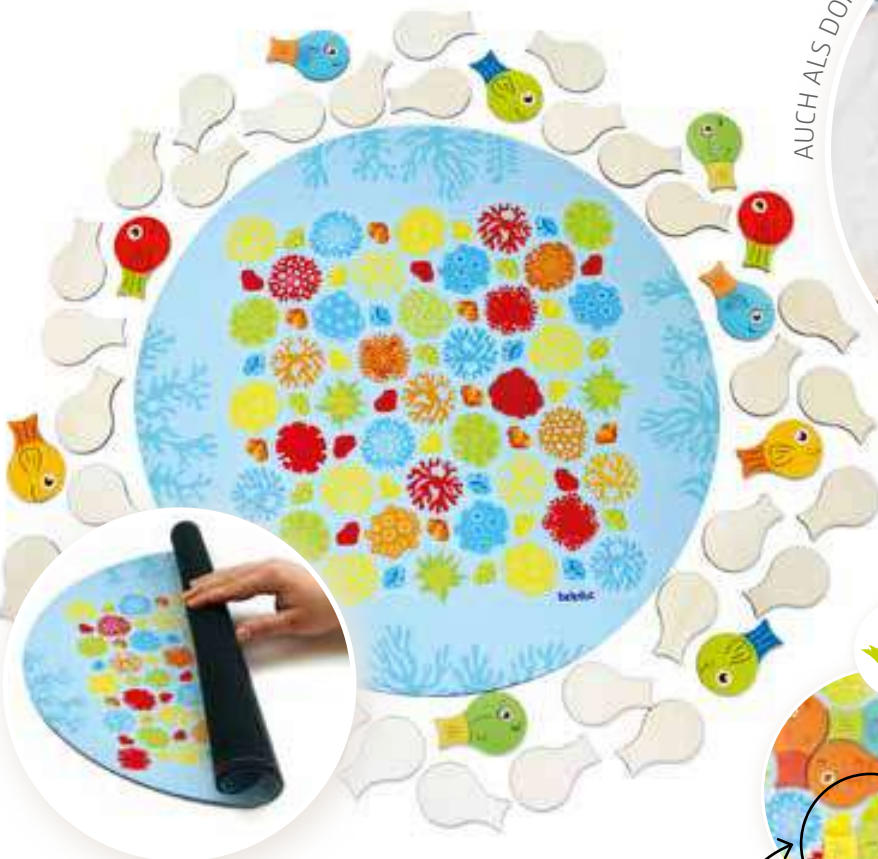

SPIELMATTE BESTEHT AUS EINER TEXTILEN OBERFLÄCHE UND GUMMIERTEM BODEN!
PLAY MAT CONSISTS OF A TEXTILE SURFACE AND RUBBERISED BOTTOM



22396 · **TASTARO**
 Ein edukatives Zuordnungsspiel zur Förderung der visuellen und taktilen Formerkennung. | An educational matching game that helps promote visual and tactile shape recognition.



22740 · **READ MY MIND**
 Mit Beobachtungsgabe und geschickten Fragen Sachen erraten. Guess things with powers of observation and clever questions.



XXL

25540 · **CASSADO**
 Ein rasantes Kugelspiel für Jung und Alt. An exciting ball game for young and old.



XXL

23654 · **OOPS!**
 Riesiges Holz-Brettspiel mit Spielfeldvertiefungen zum Tasten und sicherem Abstellen. Inklusive extra großer Spielfiguren. | Huge wooden board game with indentations on the playing field for touching and safe placement. Including extra large play figures.



XXL SPIELE – XXL GAMES



25520 · XXL HEXENKÜCHE | XXL WITCHES' KITCHEN

Die kleinen Hexenküchenmeister suchen unter den Pilzen nach den gewürfelten Farbpunkten. | The little potion brewing experts search under mushrooms for dots in the same colour as the colour that comes up on the dice.



25560 · XXL CANDY

Je nachdem, welche Kombination auf den drei Farbwürfeln erscheint, muss das dazu passende Bonbon gefunden werden. | Find the sweet with the right combination of colours that is shown on the coloured dices.



25550 · XXL RONDO VARIO

Fädeln, fertig, los! Wer zuerst sechs Teile in der gewürfelten Farbe auffädeln konnte, gewinnt. | Ready, thread, go! Whoever gets six pieces in the diced colour onto their caterpillar first wins.



25510 · XXL FISHING FEVER

Ein kniffliger Geschicklichkeitsspaß für drinnen und draußen! Mit Hilfe der Angeln werden die Fische „gefangen“ und auf ihrem jeweiligen Ständer abgelegt. | A fun but tricky game of skill! The fishes are “caught” and stored on the corresponding stands by help of the fishing rods.



LASS WACKELIGE TÜRME WACHSEN.

LET WOBBLY TOWERS GROW.



25512 · XXL TORRETA

Die Kinder spielen mit dem Farb- oder dem Punktwürfel. Mit den erwürfelten Bausteinen werden Türme gebaut. | The children use either the colour dice or the dice with dots. Depending on the colour or number of dots that come up when the dice is thrown, the children build towers.





BAUEN & EXPERIMENTIEREN

BUILDING & EXPERIMENTING

Fragen an die Welt stellen und durch Experimente beantworten!
Asking and answering questions by making experiments!





Let's play | Dieses Produkt
finden Sie auf Seite 106–107
Let's play | You can find this
product on page 106–107





LASST UNS FRÖBEL SPIELEN UND NEU ERLEBEN!

LET'S PLAY AND EXPERIENCE FRÖBEL AGAIN!

**EIN ZUKUNFTSMODELL
AUS DER VERGANGENHEIT**

**A MODEL FOR THE FUTURE
TAKEN FROM THE PAST!**

Gemeinsam mit einem Team von Experten auf dem Gebiet der Pädagogik und der mathematischen Bildung entstanden die beleduc Fröbel Sets und der Teacher Guide zu den Spielgaben 1-6.

Together with a team of experts in the field of pedagogy and mathematical education the beleduc Fröbel Sets and the Teacher Guide to the play gifts 1-6 were created.



Dr. paed. habil. Gerhard Friedrich ist Diplom-Pädagoge und unterrichtete als Lehrer die Fächer Mathematik, Technik, Pädagogik und Psychologie. Er ist Privatdozent für Allgemeine Didaktik an der Universität Bielefeld sowie Buch- und Spielautor: „**Mathematik sorgt für Ordnung in der Welt.**“

Dr. paed. habil. Gerhard Friedrich is an educator and teaches the subjects of mathematics, technology, education and psychology. He is a private tutor for general didactics at the University of Bielefeld and author of books and games: „**Mathematics create order in the world.**“



Anne Schomber, Erzieherin und Leiterin der Kindertagesstätte „Zauberwald“ in Grünberg/Hessen: „**Wir müssen Kinder mehr Zeit und Raum zum Entdecken und Erforschen geben.**“

Anne Schomber, educator and head of the kindergarten „Zauberwald“ in Grünberg/Germany: „**We have to give children more time and space to discover and explore.**“

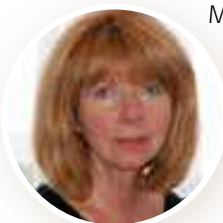

Margitta Rockstein, Pädagogin, ehemalige Leiterin Friedrich-Fröbel-Museum Bad Blankenburg: „**Mit Fröbel fängt alles an.**“

Margitta Rockstein, pedagogue, former director Friedrich-Fröbel-Museum, Bad Blankenburg/Germany: „**Everything begins with Fröbel.**“

„Spiel ist nicht Spielerei.
Es hat hohen Ernst und tiefe Bedeutung.“

„A game is not a plaything.
It has high seriousness and meaning.“



Friedrich Fröbel war einer der bedeutendsten Elementarpädagogen des 19. Jahrhunderts. Bekannt in der ganzen Welt ist er als Gründer des ersten Kindergartens in Deutschland. Er hat die

Spielgaben erfunden. Er wollte Kinder nicht etwa

von außen einfach belehren, sondern erkannte, dass das aktive kindliche Spiel der ureigene Weg der Kinder ist, sich die Welt anzueignen.

Friedrich Fröbel was one of the most important elementary pedagogues of the 19th and 20th century. He is known all over the world as the founder of the first kindergarten in Germany. He invented the play gifts. He didn't want to simply teach the children from the outside, but recognised that active childlike play is the children's very own way of learning about the world.



NEU

und einzigartig bei beleduc!

beleduc präsentiert die 6 Spielgaben nach Friedrich Fröbel. Alle Spielgaben und Informationen zu Fröbel und seiner Pädagogik werden ausführlich in dem mitgelieferten und informativen Teacher Guide erklärt. Zu jeder Spielgabe (3-6) liegt ein Booklet mit kreativen Vorlagekarten bei.

Lernen mit Herz, Hand und Verstand!

NEW

and unique by beleduc!

beleduc presents the 6 play gifts according to Friedrich Fröbel. All play gifts and information about Fröbel and his pedagogy are described in detail in the informative Teacher Guide that comes with the set. A booklet with creative template cards is provided for each play gift (3-6) in set 2.

Learning with heart, hand and mind.

**EXKLUSIV BEI BELEDUC!
EXCLUSIVE TO BELEDUC!**

160 TEILE | PIECES

SET 1

GABE 1 & 2

Starten Sie mit der Gabe 1 und zeigen Sie den Kindern die bunten Wollbälle. Je nach Alter der Kinder können Sie die Bälle entweder selbst pendeln, hüpfen und kreisen lassen, um den Kleinsten das Entdecken erster Bewegung zu ermöglichen. Weiter geht es mit Gabe 2. Lassen Sie die Kinder die einzelnen Körper anfassen. Entdecken Sie gemeinsam die Unterschiede der Körper. Mit den geometrischen Körpern lassen sich viele spannende Experimente machen.

GIFT 1 & 2

Start with play gift 1 and show the children the colourful wool balls. Depending on the age of the children, they can either swing, bounce or circle the balls themselves to enable the little ones to discover their first movements. Continue with play gift 2 and let the children touch the individual bodies. Discover the differences between the bodies together. Many exciting experiments can be done with the geometric bodies.



Für Gabe 3-6 gibt es je einen Aufsteller mit Vorlagekarten. For each gifts 3-6 there is one display with template cards.



Jedes Booklet hat den Farbcode der jeweiligen Gabe. Each booklet has the colour code of the respective gift.



Hier finden Sie alle enthaltenen Teile im Überblick sowie ein Einräumen-Schema. Here you will find an overview of all the parts and a scheme how to put it back in the box.



120 SEITEN
TEACHER GUIDE
120 PAGES
TEACHER GUIDE



40 MOTIV-VORLAGEN
40 MOTIF TEMPLATES

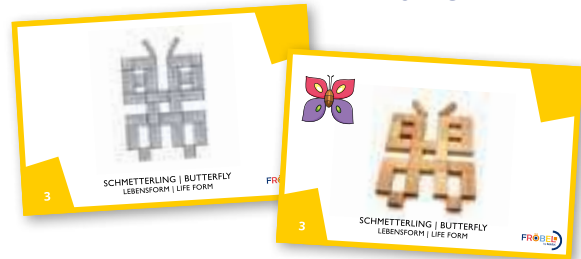

SET 2

GABE 3 | 4 | 5 | 5B | 6

Beginnen Sie hier mit Gabe 3. Nehmen Sie die Holzbox sowie das beiliegende Booklet aus der Box und stellen beides auf den Tisch. Jetzt können Sie anhand des Booklets Schritt für Schritt die Kinder auf das Spielen mit der Gabe vorbereiten.

GIFT 3 | 4 | 5 | 5B | 6

Starting with play gift 3, take the wooden box and the booklet out of the box and place it on the table. Now you can use the booklet to prepare children step by step for playing with the play gift.



FRÖBEL SET 1

ERSTES „BEWEGEN“ WAHRNEHMEN
BEIM PENDELN DES BALLES*
FIRST PERCEPTION OF "MOVEMENT"
WHEN PEDALLING THE BALL*



MIT
TEACHERGUIDE
WITH
TEACHERGUIDE



19 TLG. | PCS.

24300

FRÖBEL SET 1

Mit der „Spielgabe“ 1, den 6 Wollbällen, wird das kindliche Interesse durch seine Beweglichkeit geweckt. Mit dem Ball kann das Kind in die Welt der Bewegungen hineinfinden und es kann durch den Nachahmungstrieb inspiriert, die eigene Geschicklichkeit entwickeln. Die 2. „Spielgabe“ ist wahrscheinlich die bekannteste unter allen, was vor allem daran liegen dürfte, weil sie eine Kugel, eine Walze – heute sprechen wir eher von Zylinder – und einen Würfel enthält. Für Kinder bedeuten diese Bausteine neue Erfahrungen, denn sie laden zum Experimentieren ein.

According to Fröbel, a child's first toy is the ball. With play gift 1, the 6 woolen balls, the child's interest is inspired by its mobility. With the ball the child can find its own way into the world of movement and it can develop its own skills inspired by the instinct to imitate. The second gift is the best known of all, which is mainly because it contains a ball, a roller – today we speak of a cylinder – and a cube. For children these building blocks mean new experiences because they invite them to experiment.

Boxgröße | Box size: 400 x 300 x 130 mm



KUGEL, WÄLZE UND WÜRFEL AUF DER SCHIEFEN EBENE | BALL, ROLLER AND CUBE ON THE INCLINED PLANE

3+ FOB

NEW!

MIT FRÖBEL FÄNGT ALLES AN!
EVERYTHING BEGINS WITH FRÖBEL!
DAS GREIFEN KOMMT VOR DEM BEGREIFEN!
GRASPING COMES FROM COMPREHENDING!

SEID EINFACH KREATIV!
JUST BE CREATIVE!



HANDGEFERTIGTE BÄLLE AUS WOLLE
HANDMADE BALLS
MADE OF WOOL



DREH-EXPERIMENT MIT WÜRFEL UND STAB | ROTATION EXPERIMENT WITH CUBE AND ROD



UNBEDINGT ANSCHAUEN!
I HAVE A LOOK!
Kids Video

*nur in Begleitung eines Erwachsenen
*Only in the presence of an adult



FRÖBEL SET 2



24301

141 TLG. | PCS.

FRÖBEL SET 2

Der Begriff „Spielgabe“ bedeutet, dass es sich bei den Fröbelschen Gaben um Spielmaterialien handelt, die wir den Kindern „geben“. Die Baukästen enthalten von einfachen Körpern wie den Würfeln bis hin zu Viertelwürfeln und Dreiecksprismen verschiedene Formen, die aufeinander in ihrer Schwierigkeit aufbauen. Insgesamt gibt es fünf verschiedene Baukästen. Diese sind generell so angelegt, dass sie das Kind durch ihre elementaren Formen zum Spielen, Experimentieren und Konstruieren anregen. Mit den Spielgaben 3 bis 6 lassen sich neben Lebensformen, auch Schönheits- und Erkenntnisformen konstruieren. Um die pädagogischen Aspekte aus Fröbels Zeiten in das 21. Jahrhundert zu transportieren, können die Kinder Materialien aus der heutigen Zeit verwenden, um die Spielgaben kreativ zu ergänzen.

The term „play gift“ means that the Fröbel gifts are play materials which we „give“ to children. The construction sets contain various shapes that build on another in different levels of difficulty, from simple solids such as cubes to quarter cubes and triangular prisms. There are a total of five different building sets. These are generally designed to encourage the child to play, experiment and construct through their elementary forms. The play gifts 3 to 6 can be used to construct forms of life, forms of cognition and forms of beauty. In order to transfer the educational aspects from Fröbel's time into the 21st century, the children can use materials from today to complement creative play gifts.

Boxgröße | Box size: 400 x 300 x 130 mm



IDEAL ALS EINZELBESCHÄFTIGUNG
ODER DAS SPIEL IN DER GRUPPE
IDEAL AS AN INDIVIDUAL ACTIVITY
OR PLAY IN A GROUP

VOM EINFACHEN ZUM KOMPLEXEREN
FROM THE SIMPLE TO THE MORE COMPLEX

MIT DEN VORLAGEN-KARTEN BAUEN
ODER EINFACH KREATIV SEIN
BUILD WITH THE TEMPLATE CARDS
OR SIMPLY BE CREATIVE

MIT UMFANGREICHEM
ZUSATZMATERIAL FÜR
EINE PROJEKTWOCHE
WITH ADDITIONAL
MATERIAL FOR A
PROJECT WEEK
WWW.BELEDUC.DE

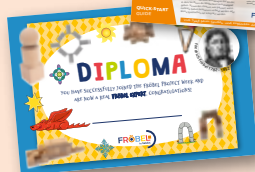

EIN ZUKUNFTSMODELL
AUS DER VERGANGENHEIT
A FUTURE MODEL
FROM THE PAST



MIT TEACHER GUIDE
UND BOOKLET
WITH TEACHERGUIDE
AND BOOKLET





LET'S PLAY

Spielen erste Melodien einfach und mit Spaß!

Musical fun – play simple first melodies!



INKLUSIVE LIEDERBUCH
MIT 16 MELODIEN
INCLUDING SONGBOOK
WITH 16 SONGS





XL

21024

LET'S PLAY – KLANGKOFFER

Spielen erste Melodien einfach und mit Spaß! Mit „Let's Play“ werden Kinder spielerisch an Musik herangeführt, sie lernen Töne bewusst wahrzunehmen, Rhythmen zu spielen und erste Melodien zu kennen. Jedes Kind kann hier nach einer kurzen Einweisung sofort beginnen, ohne Noten und Tonleitern im Detail zu kennen. Es entstehen erste Melodien und Lieder. Musik und Rhythmik fördern schon früh die Wahrnehmung und die Kreativität von Kindern. Durch Musizieren können diverse Fähigkeiten der Kinder, wie zum Beispiel die kognitive und soziale Kompetenz nachhaltig positiv beeinflusst werden.

LET'S PLAY – MELODY BOX

Play first melodies easily and with fun! With "Let's Play", children are introduced to music in a playful way, they learn to be aware of tones, to play rhythms and to know their first melodies. Every child can start immediately after a short introduction, without knowing notes and scales in detail. The first melodies and songs are created. Music and rhythm support children's perception and creativity at an early age. Making music can have a lasting positive influence on various abilities of children, such as cognitive and social skills.

Boxgröße | Box size: 400 x 300 x 60 mm



Or Dobkowski

Physiker, Instrumentenbauer, Israel |
physicist, instrument maker

& Dor Adamstein

Unternehmer, Holzbearbeiter, Israel |
Entrepreneur, woodworker, Israel

Dor & Or entwarfen dieses Produkt mit dem Ziel jedem die Möglichkeit zu geben, Musik zu erleben und Melodien zu spielen. Eine Melodie zu spielen ist eine magische Erfahrung, die jeder machen sollte!

Dor & Or designed this new product with the goal of allowing anyone to experience music and play melodies for the first time. Playing a melody is a magical experience that anyone should have!



JEDER KANN ES SPIELEN!
EVERYONE CAN PLAY IT!

HOCHWERTIGE HOLZBOX MIT 39 ALUMINIUM-KLANGSTÄBEN
HIGH-QUALITY WOODEN BOX WITH 39 SOUND PIPES

DIE KLANKÖRPER KÖNNEN IN FREIER REIHENFOLGE ODER NACH EINER VORLAGE BEFESTIGT WERDEN
THE SOUNDPIECES CAN BE FIXED EITHER IN RANDOM ORDER OR ACCORDING TO A TEMPLATE





XXL EISENBAHN SET

Viel los am Bahnhof und auf den Gleisen!

There is a lot going on at the station and on the tracks!

NEW!



KRAN MIT MAGNETISCHER
WINDE ZUM HEBEN
SCHWERER LADUNG
CRANE WITH MAGNETIC
WINCH FOR LIFTING HEAVY
LOADS



RAILWAY



92 TLG. | PCS.

24201

XXL EISENBAHN SET

Mit dem XXL Eisenbahn-Set können mehrere Kinder gleichzeitig spielen. Das umfangreiche Eisenbahn-Set besteht aus robusten Holzschienen. Figuren, Bäume und Verkehrsschilder, aber auch verschiedenste Züge, ein Bahnhof, eine Bahn-schranke, Brücken und Tunnel gehören dazu. Die Fahrgäste werden ans Ziel transportiert und mit-hilfe eines Krans kann Ware direkt vom Waggon abgeladen werden. Die Schranken des Bahnüber-gangs können geöffnet und geschlossen werden für noch mehr Spielspaß. Perfekt für das Spiel in der großen Gruppe!

XXL RAILWAY SET

Several children can play at the same time with the XXL railway set. The large railway set consists of solid wooden rails. Figures and traffic signs, but also various trains, a station, a railway barrier, bridges and tunnels are part of it. The passengers are transported to their destination and goods can be unloaded directly from the wagon with the help of a crane. The barriers of the railway crossing can be opened and closed for even more play fun. Perfect for playing in a group!

Boxgröße | Box size: 470 x 340 x 240 mm



Baue deine eigene Welt!
Build your own world!



SPIELFIGUREN PASSEN IN DIE WAGGONS | PLAY FIGURES FIT INTO THE WAGGONS

IDEAL FÜR DIE GANZE GRUPPE!
PERFECT FOR THE WHOLE GROUP!
ES KÖNNEN ÜBER 5 M SCHIENENNITZ GEBAUT WERDEN!
OVER 5M TRACK CAN BE BUILT!
4 VERSCHIEDENE EISENBAHN-SETS,
3 UNTERSCHIEDLICHE BAHNHÖFE U.V.M.
4 DIFFERENT RAILWAY SETS,
3 DIFFERENT STATIONS AND MUCH MORE





QUADRILLA

LASST DIE KUGELN ROLLEN!
LET THE MARBLES ROLL!



256 TLG. | PCS.

24210

QUADRILLA (XXL SET)

Die Quadrilla Kugelbahn ist ein hochwertiges Holzspielzeug, das durch sein Baukastensystem die Kreativität der Kinder fördert. Quadrilla ist die erste Kugelbahn der Welt, bei der die Murmeln auf horizontalen Schienen laufen. Allein durch unterschiedliche Fallwege und Beschleuniger im Quader bekommt die Murmel ihren Schwung. Spannend ist vorallem, dass die Quader unterschiedliche Funktionen haben: mal fällt die Kugel senkrecht durch ein Loch, mal läuft sie nach links oder rechts weiter.

The Quadrilla marble run is a high-quality wooden toy, with many different building possibilities due to its modular structure which fosters creativity. It is the world's first marble run where marbles are rolling on horizontal tracks. The marbles gather momentum by rolling through the different holes in the connecting cubes. These cubes make the quadrilla exciting and versatile, since different openings at the bottom and to the left or right side guide each marble.

Boxgröße | Box size: 470 x 340 x 240 mm



in cooperation
with Hape

150 QUADRILLA BAUTEILE +
100 MURMELN
150 QUADRILLA BUILDING
PIECES + 100 MARBLES

SCHRITT-FÜR-SCHRITT ANLEITUNG
STEP BY STEP INSTRUCTIONS

MIT PRAKTISCHER
AUFBEWAHRUNGSBOX
IN PRACTICAL STORAGE BOX

6 Vorlage-
Karten mit 8
Konstruktionen

6 template cards
with 8 ideas to
start building

DIE ERSTE KUGELBAHN DER WELT MIT
HORIZONTALER SCHIENEN!
THE WORLD'S FIRST MARBLE RUN FEATURING
MARBLES THAT RUN ON HORIZONTAL TRACKS

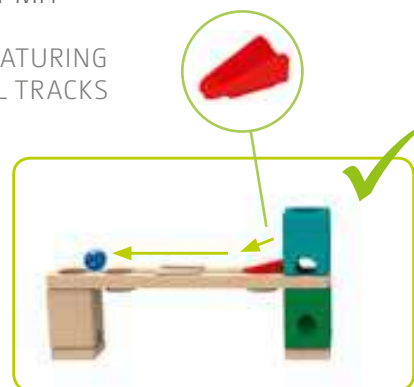
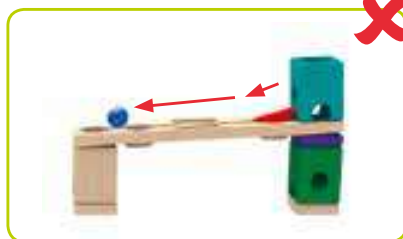

3 VERSCHIEDENE SCHWIERIGKEITSSTUFEN
3 LEVELS OF DIFFICULTY

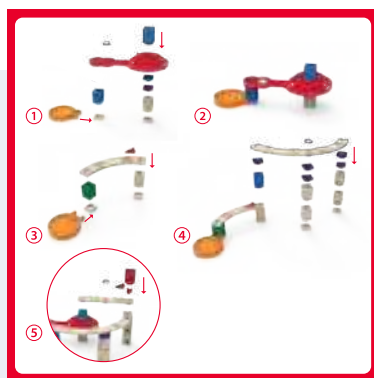



500 TLG. | PCS.

FLEXISTIX



24200

FLEXISTIX (XXL SET)

Die bunten Bambusstäbe mit flexiblen Verbindern laden die Kinder zum endlosen kreativen Bauen ein. 20 Vorlagekarten geben Anhaltspunkte, wie das Stecksystem genutzt werden kann und erste Inspirationen für unterschiedlichste Bauwerke. Mit den Stäben können geometrische Formen, sowie tolle große Projekte realisiert werden. Schnell lernen die Kinder, wie die unterschiedlichen Teile zusammengesteckt werden und können eigene, große Konstruktionen erschaffen.

The colourfull bamboo sticks with flexible connectors invite children to build creatively. 20 template cards can be used as a building aid on how different structures can be assembled. Smaller geometrical forms as well as larger projects can be realised easily, and children learn very quickly how to connect the different parts to create their own amazing building structures.

Boxgröße | Box size: 385 x 295 x 195 mm

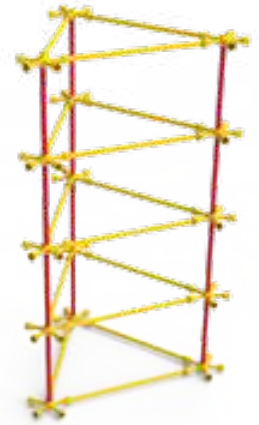

IN PRAKTISCHER AUFBEWAHRUNGSBOX
IN PRACTICAL STORAGE BOX
SCHRITT-FÜR-SCHRITT ANLEITUNGEN
STEP BY STEP INSTRUCTIONS



in cooperation with Hape

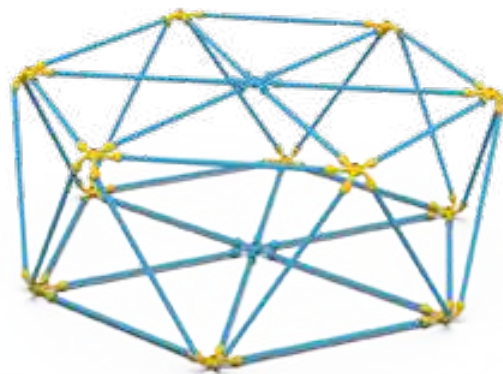

20 Vorlagekarten inklusive
20 template cards included

3 VERSCHIEDENE SCHWIERIGKEITSSTUFEN
3 LEVELS OF DIFFICULTY

383 STÄBE IN 6 VERSCHIEDENEN LÄNGEN + 97 VERBINDETEILE
383 STICKS IN 6 DIFFERENT LENGTHS + 97 CONNECTORS

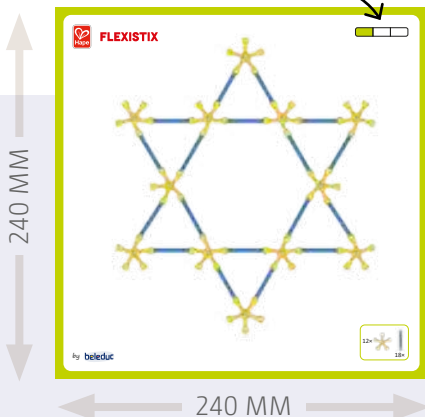



JUNIOR INVENTOR

JUNIOR INVENTOR



24220

201 TLG. | PCS.



IDEAL FÜR DAS GRUPPENSPIEL
GROUP OF CHILDREN CAN
PLAY AT THE SAME TIME

185 BAUTEILE + VORLAGEKARTEN
185 PARTS + EXPERIMENT CARDS



JETZT WIRD
EXPERIMENTIERT!
START EXPERIMENTING
NOW!

JUNIOR INVENTOR (XXL SET)

Kinder sind von Natur aus neugierig und wollen die Welt um sich herum entdecken. Die Junior Inventor Werkbank wurde an diese Bedürfnisse angepasst und bietet den Kindern einen spielerischen Zugang zu naturwissenschaftlichen Experimenten. 15 Vorlagekarten mit tollen Versuchen zu physikalischen Phänomenen und mechanischen Funktionsweisen können erforscht und weiterentwickelt werden. Es geht nicht darum starre Strukturen nachzubauen, sondern vielmehr, um von der Umwelt zu lernen und neue Dinge zu entdecken.

Children are naturally interested in experimenting and inventing. Our new inventor kindergarten set offers everything young explorers need to playfully discover mechanic phenomena and relations. 15 template cards with amazing experiments on physical and mechanical phenomena can be explored and developed further. The focus is not on simply recreating the template cards, but on discovering the underlying principles and try own experiments as well.

Boxgröße | Box size: 740 x 150 x 500 mm

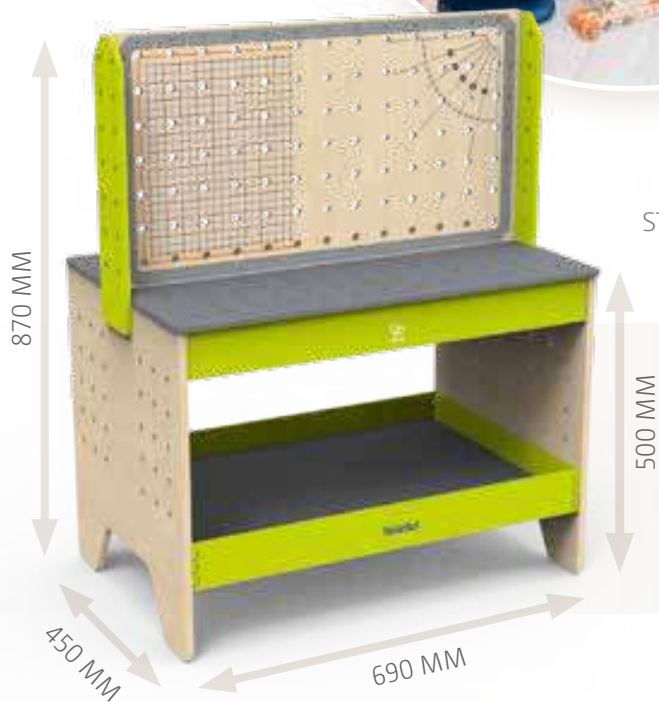

Dieses Set bietet Experimente zu

- KRAFTÜBERTRAGUNG · Hebelwirkung, Umlenkrolle, Zahnrad
- MAGNETISMUS
- OPTIK / visuelle Effekte
- FREIES SPIEL · handwerkliches Geschick mit Schrauben, Muttern und Schraubenziehern

This set offers experiments on

- TRANSMISSION · Leverage, Idler pulley, Gear wheels
- MAGNETISM
- OPTIC / visual effects
- FREE PLAY · Improve DIY skills with screws, nuts and screwdrivers

3 VERSCHIEDENE SCHWIERIGKEITSTUFEN
3 LEVELS OF DIFFICULTY

15 Experimente-Karten
15 experiment cards

in cooperation with Hape

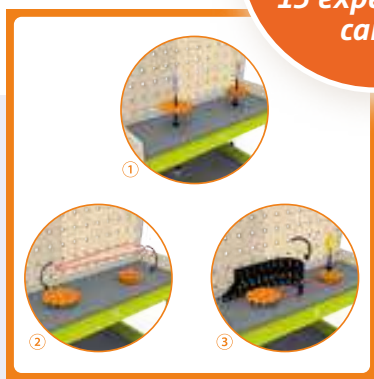



23607

RASSELBANDE

Mit diesem Soundmemo können Kinder gleiche Töne erkennen! Die Boxen sind mit unterschiedlichen Inhalten gefüllt und immer 2 passen zusammen.

SOUND BOX

With this sound memo, children can recognise the same sounds! The boxes are filled with different contents and always 2 fit together.

Boxgröße | Box size: 325 x 250 x 90 mm



23608

GEWICHTEBOX

Mit dem Gewichtememo können Kinder 2 gleich schwere Gewichte erfühlen. Wer findet die Paare?

WEIGHT BOX

With the weight memo, children can find 2 weights of the same weight. Who can find the pairs?

Boxgröße | Box size: 220 x 180 x 70 mm



23614

TANDEM-TAFELN

Förderung der grundlegenden Fähigkeiten zum Lesen- und Schreibenlernen durch Schulung der Auge-Hand-Koordination, der Feinmotorik sowie der Konzentration. Gute für Menschen mit körperlichen Einschränkungen.

TANDEM BOARDS

Encouragement of the basic ability to read and write by training hand-eye-coordination, fine motor skills and the ability to concentrate. Good for people with physical limitations.

Boxgröße | Box size: 540 x 360 x 110 mm



INKL. MASSIVER HOLZBOX ZUR AUFBEWAHRUNG
INCL. SOLID WOODEN BOX FOR STORAGE



475 MM



22 Vorlagekarten mit
2 Schwierigkeitsstufen.
22 template cards with
two difficulty levels.



280 MM



DECKEL UND BOXUNTERSEITE MIT
MAGNETISCHER SPIELFLÄCHE
SLIDING LID AND BOTTOM SIDE OF THE BOX
WITH MAGNETIC PLAYING SURFACE



24040

TANGEO

Die unterschiedlichen magnetischen Holzteile lassen sich durch viele Kombinationsmöglichkeiten zu neuen Formen anordnen. Abgeleitet vom chinesischen Tangram, entstehen durch kleine Handgriffe immer wieder neue Bilder, wobei die Vorlagekarten als Inspiration genutzt werden können. Die Kinder lernen ganz spielerisch geometrische Formen und deren Zusammenspiel kennen und schulen dabei Feinmotorik und Konzentrationsfähigkeit.

The various magnetic wooden pieces can be arranged into new shapes through many different possible combinations. Derived from Chinese Tangram, countless new pictures can be created with just a few movements, whereby the template cards can be used for inspiration. By playing, children learn about geometric shapes and their relationships, and in doing so train their fine motor skills and ability to concentrate.

Boxgröße | Box size: 280 x 275 x 65 mm



Selbstkontrolle auf
der Rückseite der Karten
Self-check on the back
of the cards

LEVEL 1
Einstiegsvariante
Beginner version



LEVEL 2
Fortgeschrittenvariante
mit Magnetwand
Advanced version with
magnetic board



LEVEL 3
Fortgeschrittenvariante
mit Spiegelwand
Advanced version with
mirror board

DANEHEN, DAHINTER
ODER DAVOR...
NEXT TO, BEHIND
OR IN FRONT...



21006

TOPOLOGO »VISIO«

„Daneben“, „Dahinter“ oder „Davor“ – mit ToPoLoGo „Visio“ können zweidimensionale Abbildungen spielerisch dreidimensional nachgebaut und räumliche Positionen nachempfunden werden. Die Spielkarten in drei Schwierigkeitsgraden zeigen Figuren und Szenarien unterschiedlicher Anordnung, die es auf der Rasterplatte oder an der Magnet- bzw. Spiegelwand nachzubauen gilt. Hier sind vor allem räumliches Denken und Vorstellungskraft gefragt.

“Next to”, “behind” or “in front” – with ToPoLoGo “Visio” two-dimensional images can be copied three-dimensionally, and spatial positions can be understood easily. The cards are assigned to three levels of difficulty and show sceneries and figures in different positions, which need to be copied on the grid board – depending on the game variation also using the magnetic or mirror board. Spatial sense and imagination are trained in particular.

Boxgröße | Box size: 248 x 248 x 120 mm



FLYING COLOURS



HIGHLIGHT! ABNEHMBARE UND ABWASCHBARE SCHUTZWANNE
REMOVABLE AND WASHABLE PROTECTIVE TRAY



A 68500

FLYING COLOURS

Mit der Farbenschleuder lassen sich auf einfache Art und Weise ausdrucksstarke und dynamische Bilder zaubern. Vor oder beim Drehvorgang wird einfach Farbe auf das Papier gegeben und die Fliehkraft lässt tolle Muster entstehen.

The colour centrifuge gives children a simple way of conjuring up expressive, dynamic works of art. Paint is simply applied to the paper before or during the spinning process, and the centrifugal force creates super patterns.

Größe | Size: 690 x 500 x 130 mm

AUCH IN CREATIVE WORLD (S. 218)
 ALSO IN CREATIVE WORLD (P. 218)



B 68501

20 x PLASTIKFLÄSCHCHEN + 5 x SCHABER SET OF 20 BOTTLES + 5 SCRAPERS

Größe | Size:
 150 x 45 x 45 mm (Flaschen | bottles)
 115 x 18 x 10mm (Schaber | scrapers)





POLY-M

Kreativer Bauspaß mit bunten Bausteinen.
Creative building fun with coloured building blocks.



POLY-M FÜR DIE KLEINSTEN

POLY-M FOR THE YOUNGEST

VORTEILE

ADVANTAGES



VERTRAUEN

- Made in Germany seit 1980
- Geprüfte Materialien
- Umweltschonende Herstellung
- Sorgfältige Kontrolle / TÜV Richtlinien
- Sicher für Kinder ab 12 Monate

RESPONSIBILITY

- Made in Germany since 1980
- Tested materials
- Environmentally friendly production
- Thorough inspections / TÜV guidelines
- Safe for children of 12 months and older



PRODUKTEIGENSCHAFTEN

- Hygienisch, da waschbar (Waschmaschine bei 40°)
- Für Mädchen und Jungen gleichermaßen interessant
- Weiches, flexibles Material
- Angenehme Haptik, abgerundete Ecken
- Extra große Steine, maximale Sicherheit für kleine Kinderhände
- Besonders gute Qualität – langlebig und robust
- Leiser als die meisten anderen Baumaterialien
- Spielspaß für Kinder ab 12M+

PRODUCT CHARACTERISTICS

- Hygienic – machine-washable (at 40°)
- Equally interesting for girls and boys
- Soft, flexible material
- Pleasant feel – round corners
- Extra large bricks for maximum safety and small children's hands
- Especially high quality – long-lasting and robust
- Quieter than most other building materials
- Play fun for children of 12+ months



BAUEIGENSCHAFTEN

- Leichtes Stecken und Lösen da vakuumfrei – Luftöffnung in jedem Stein
- Kein Verkanten der Steine – die abgerundeten Zapfen gleiten ineinander
- Kreatives Bauen (waagrecht, senkrecht, dreidimensional und sogar rundes Bauen) ist möglich
- Kompatibel mit allen Steinen und Zubehör von Poly-M
- Große multifunktionale Bausteine
- Mit ergänzenden Anleitungen und Vorlagekarten

BUILDING CHARACTERISTICS

- Easy building and deconstruction because all bricks are vacuum-free – small opening in each block
- No jamming – the bricks glide onto each other easily due to the rounded nubs
- Creative building (horizontal, vertical, three-dimensional and also circular structures)
- Compatible with all blocks and other equipment of Poly-M
- Large multifunctional building bricks
- With complementary instructions and template cards



FÖRDERBEREICHE

- Erlernen und Benennen der Farben
- Erkennen und Umsetzen verschiedener Formen
- Schulung der Feinmotorik
- Förderung von Kreativität & Fantasie

DEVELOPMENT AREAS:

- Learning and naming colours
- Recognising and building different shapes
- Training fine-motor skills
- Promoting creativity & fantasy





BASIC BAUSTEINE AB 1 JAHR

- Große, multifunktionelle Bausteine
- Einfaches Zusammenstecken und Bauen in verschiedene Richtungen (waagrecht, senkrecht, dreidimensional, rund)
- Sicher für die Kinderkrippe

Förderung von: Farben und Formen, Feinmotorik, Kreativität

BASIC BUILDING BRICKS FROM 1 YEAR

- Large and multifunctional building bricks
- Easy assembly and building in different directions: horizontal, vertical, three-dimensional circular
- Safe for nursery school

Development of: Colours and shapes, Fine motor skills, Creativity



EXTRA GROSSE BAUSTEINE FÜR DIE KLEINSTEN
LARGER BUILDING BLOCKS FOR THE SMALLEST CHILDREN

12 VORMONTIERTE AUTOS ZUM KREATIVEN GESTALTEN
12 PRE-ASSEMBLED CARS FOR CREATIVE DESIGNS

INKLUSIVE 12 BAUERNHOFTIERE
WITH 12 FARM ANIMALS INCLUDED



500 TLG. | PCS.

20015

FREISPIELSET »FIRST BLOCKS«

Großes Set – vielfältige Möglichkeiten. Das Set bietet sich perfekt für das gemeinsame Spiel im Kindergarten an.

FREEPLAY SET »FIRST BLOCKS«

Big set – wide variety. This set offers the perfect solution for social play in the kindergarten.



SETS FÜR 12M+

SETS FOR 12M+



118 TLG. | PCS.

20005

FIRST BLOCKS

Kleine Kinder werden große Baukünstler und können ganz schnell fantasievolle Tiere und Konstruktionen entstehen lassen!

Even youngest children become great builders that can create fantasy animals and other constructions!

Multibox M: 380 × 280 × 190 mm

12
M+

118

Alle Sets
inklusive Bau-
anleitungskarte
All sets template
card included



218 TLG. | PCS.

20010

FIRST BLOCKS CLASS-SET

Große und handliche Bausteine schaffen schnelle Bauerfolge und fördern das kreative Spiel.

Large and easy-to-handle building bricks provide quick building successes and thus stimulate creative play.

Multibox L: 380 × 280 × 270 mm

12
M+

218



300 TLG. | PCS.

20020

TWINI BIG BLOCKS

Stein auf Stein können die extra großen Bausteine gesteckt werden. Aufgrund ihrer Größe sind sie besonders gut für kleine Kinderhände geeignet.

The extra large building blocks can be stacked on top of each other. They are especially well suited for small children's hands due to their size.

12
M+

300



170 MM



KREATIVE BAUSTEINE AB 3 JAHREN

- Multifunktionelle Bausteine
- Bauen in verschiedene Richtungen (waagrecht, senkrecht, dreidimensional, rund)
- Geometrische Formen, Erlernen von Statik und Technik

Förderung von: Farben und Formen, Feinmotorik, Kreativität & Fantasie

CREATIVE BUILDING BRICKS FROM 3 YEARS

- Multifunctional building bricks
- Building in different directions: horizontal, vertical, three-dimensional, circular
- Geometrical shapes, first experiences in structural engineering/technology

Development of: Colours and shapes, Fine motor skills, Creativity



190 TLG. | PCS.

20305

KREATIVSET

Diese Bausteine bieten den Kindern erste Erfahrungen mit Statik und Technik zu machen.

CREATIVE SET

These building bricks provide the children with first experiences in structural engineering and technology.



*Inklusive
Bauanleitungsheft*
*Building
instruction
included*



**BEST
SELLER**



400 TLG. | PCS.

20240

GRUPPENSET

Grenzenlose Möglichkeiten bieten diese 400 Bausteine für die Kinder.

GROUP SET

400 building bricks offer unlimited possibilities for children.





MEINE WELT MY WORLD



Kreatives Freispiel

Tom und seine Frau Anna sind mit ihren 2 Kindern auf einen Erlebnisbauernhof gefahren! Während Sohn Andy auf einem Pferd reitet, kümmert sich seine Mutter um die kleine Lisa. Die anderen Kinder schauen auch schon gespannt, welche Tiere es noch zu entdecken gibt!

Creative Freeplay

Tom and his wife Anna went to an adventure farm together with their 2 children! While their son Andy is riding a horse, his mother is caring for baby Lisa. The other kids are looking around curiously which other animals can be discovered on the farm!

Inklusive
Bauanleitungsheft
Building
instruction
included



550 TLG. | PCS.

20220 · JUMBO
Polybag



9 TIERE | ANIMALS



Inklusive
Bauanleitungsheft
Building
instruction
included

20505 · BAUERNHOFTIERE | FARM ANIMALS





ERGÄNZUNGSSETS & ZUBEHÖR

ADDITIONAL ARTICLES

Mit diesen Artikeln können die bestehenden Sets ergänzt und erweitert werden, da alle Poly-M Bausteine kompatibel sind.

These articles can expand or be added to the existing sets as all Poly-M building bricks are compatible.

20800
MEGA-BAUPLATTEN
MEGA CONSTRUCTION
PLATES
Größe | Size: 380 x 280 x 18 mm



2ER SET
SET OF 2

24 M+ 2



20205 · **CLASSIC**
3+ 180 !1

1ER, 2ER & 3ER STEINE | BUILDING
BRICKS WITH 1, 2 AND 3 NUBS



20802
GRUNDPLATTEN
BASE PLATES
Größe | Size: 135 x 55 x 18 mm

24 M+ 10



20801
GRUNDPLATTEN MIT KOPPLUNG
BASE PLATES WITH COUPLINGS
Größe | Size: 210 x 57 x 18 mm

24 M+ 4



20804
RADSÄTZE
WHEEL SETS
Größe | Size: 105 x 37 x 37 mm

24 M+ 12



MULTIBOX S
20900: Rot | Red
20901: Blau | Blue
Größe | Size: 380 x 280 x 100 mm

2



MULTIBOX M
20904: Blau | Blue
Größe | Size: 380 x 280 x 190 mm

2



MULTIBOX L
20906: Rot | Red
20907: Blau | Blue
20908: Grün | Green
Größe | Size: 380 x 280 x 270 mm

2

POLY-M

THEME PARK



Inklusive
Bauanleitungsheft
Building
instruction
included



150 TLG. | PCS.

20110 · **STARTER**
Multibox M: 380 × 280 × 190 mm

24 M+ 150

104
TEILE | PCS



20700 · **HAPPY FLOWERS**

3+ 104



Inklusive
Bauanleitungsheft
Building
instruction
included

20705 · **MOSAIC**
Boxgröße | Box Size: 380 × 280 × 100 mm

3+ 125 1



11 FIGUREN | FIGURES

20500 · **FREUNDE AUS ALLER WELT
FRIENDS FROM ALL OVER THE WORLD**

18 M+ 47



WAND- & RAUMELEMENTE

WALL- & ROOM ELEMENTS

Erlebnisspielplätze für Kinder an den Wänden.
Adventure playgrounds for kids on the walls.





WANDSPIELOBJEKT »RAUPE«

Die fünf Einzelelemente ergeben eine außergewöhnliche Wandgestaltung und bieten mehreren Kindern verschiedene Spielmöglichkeiten. Die klaren Designs verdeutlichen die Spielideen und haben einen hohen Aufforderungscharakter. Gefördert werden Motorik, Kreativität und Kommunikation.

WALL TOY »CATERPILLAR«

The five individual elements present an exceptional wall decoration and offer children different possibilities to play. Clear designs with a high stimulative nature point out the various options to play. Motor activity, creativity and communication are fostered in particular.

Größe | Size: 450 × 480 mm
(23630: Größe | Size: 540 × 480 mm)

3+ FOB



MIT MAGNETSTIFT
WITH MAGNETIC PEN



23632 · WAAGE | BALANCE

Mit Hilfe des Magnetstiftes werden die Kugeln auf die Waage befördert.

With the help of the magnetic pen the balls are carried onto the pair of scales.



FÖRdert MOTORIK,
KREATIVITÄT UND
KOMMUNIKATION
DEVELOPS MOTOR
SKILLS, CREATIVITY AND
COMMUNICATION SKILLS



1900 MM



23630 · KOPF | HEAD

Die unterschiedlichen Elemente gleiten an den Motorikschleifen entlang und schulen die Auge-Hand-Koordination sowie die Motorik.

The different elements are gliding over the play wires and train hand-eye-coordination and fine motor skills.



23631 · DREHLABYRINTH | TURNING AROUND LABYRINTH

Ein Magnetstift hält die Kugeln und hilft beim Transport durch das Räder-Labyrinth.

Balls can be transported through the wheel labyrinth by the help of the magnetic stick.



23633 · KREISEL | PEGTOP

Wird der orange Kreis gedreht, bewegen sich ebenso alle anderen Kreise. Je nach Geschwindigkeit entstehen die unterschiedlichsten Bilder und erzeugen besondere visuelle Reize.

By turning the orange wheel, all other wheels are turning, too. Depending on the speed, special visual effects will arise.



23634 · UHR | CLOCK

Eine Uhr für den spielerischen Umgang mit der Zeit. Die kleinen Rädchen zeigen die vier verschiedenen Jahreszeiten und vier unterschiedliche Tageszeiten.

A clock that offers a playful access to the topic "time". The small wheels show the four different seasons and four different times of a day.



4 Jahreszeiten
4 seasons



23610



TRAINS THE CHILDREN'S MOTOR SKILLS

TRAINIERT DIE MOTORISCHEN FÄHIGKEITEN DER KINDER

23612

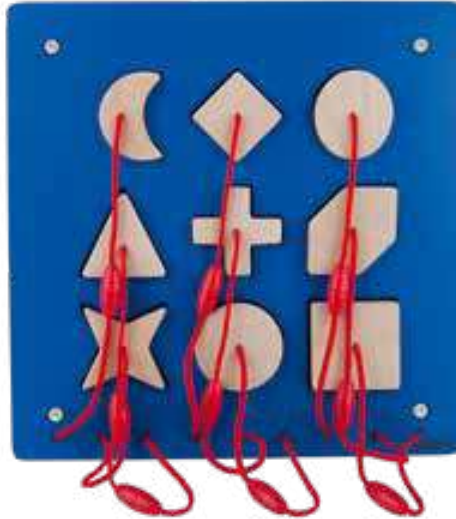

23622 · WELLE | WAVE



23621 · SCHMETTERLING | BUTTERFLY



23623 · BERGE | MOUNTAINS



23610

WANDELEMENT »LABYRINTH«

Mit viel Geschick und guter Beobachtungsgabe gilt es, die Scheibe auf dem richtigen Weg vom Ausgangs- zum Endpunkt zu befördern.

WALL ELEMENT »LABYRINTH«

With much skill and good observation the disk needs to be moved from the starting point to the endpoint.

Größe | Size: 400 x 400 x 30 mm



23612

WANDELEMENT »STECKFORMEN«

Dieses Wandelement fördert spielerisch das Erkennen und Zuordnen von Negativ- und Positivformen.

WALL ELEMENT »SHAPES«

This wall element encourages recognition and matching of negative and positive forms in a playful way.

Größe | Size: 400 x 400 x 30 mm



Unsere innovativen Wandelemente für Kinder ab 3 Jahren trainieren die Muskulatur, unterstützen die motorischen Fähigkeiten und verbessern das Koordinationsvermögen.

Our innovative wall elements for children 3 years and over train musculature, support motor skills and improve co-ordination abilities.

Größe | Size: 600 x 500 x 30 mm



SEITLICHER GRIFF ZUM HALTEN
SIDE HANDLE FOR SECURE HOLD



RÜCKENSCHONEND!
BACK-FRIENDLY!

STUFE KANN
EINGEKlapPT
WERDEN!
STEP CAN BE FOLDED!

68000 · ANZIEHHILFE

ErzieherInnen können mit der Anziehhilfe eine bequeme Sitzhaltung einnehmen und den Kindern auf diese einfache Art und Weise Schuhe sowie Jacken anziehen. Für die Kinder ist ein seitlicher Griff angebracht, um einen sicheren Stand zu gewährleisten.

SMART BENCH

Teachers can have a comfortable sitting position and are able to assist children as they put on jackets and shoes with the help of the Smart Bench. It also has a side handle that offers a secure hold for the child.

FOB Größe | Size: 830 × 600 × 780 mm

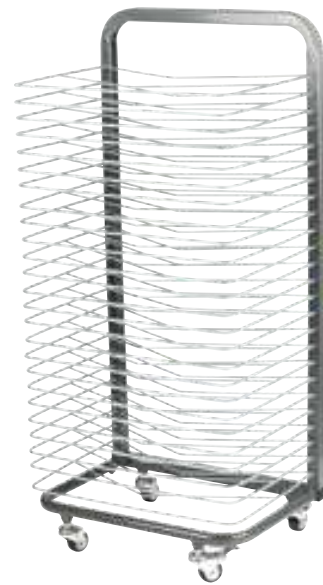

68120 · TROCKENWAGEN

Der Trockenwagen hält mit seinen 25 Lagen Platz für 25 Blätter im DIN A3- oder 50 im DIN A4-Format bereit. Mit den vier praktischen und zwei feststellbaren Rädern kann er im Raum flexibel verschoben werden und sorgt für einen festen Stand.

DRYING SHELF

The Drying Shelf has 25 layers and holds 25 sheets in DIN A3 format or 50 sheets in DIN A4 format. Due to four practical wheels, two of which are lockable, it can be flexibly moved in a room while having a secure stand.

FOB Größe | Size: 460 × 330 × 980 mm



Für 30 Paar
Schuhe!
Suitable for
30 pairs
of shoes!

68030 · STIEFELWAGEN

Auf dem Stiefelwagen haben bis zu 30 Stiefel- oder Schuhpaare Platz. Die Metallwanne ermöglicht das Auffangen von Schmutz und Wasser.

BOOT HANGER

The Boot Hanger holds 30 pairs of shoes or boots. The metal tub catches water and dirt.

FOB Größe | Size: 1110 × 400 × 980 mm



VON BEIDEN
SEITEN
NUTZBAR!
USEABLE FROM
BOTH SIDES!

Für zwei
Kinder geeignet!
Suitable for
two children!

68010 · SCHUHAUSZIEHER

Der Schuhauszieher unterstützt die Kinder beim selbstständigen Ausziehen von Schuhen und Stiefeln. Er ist von beiden Seiten nutzbar, sodass zwei Kinder gleichzeitig ihre Schuhe ausziehen können.

BOOT TAKER

The Boot Taker helps children take off their shoes and boots on their own. It is useable from both sides, so that two kids can take off their shoes at the same time.

FOB Größe | Size: 400 × 390 × 600 mm



ROLLENSPIEL ROLEPLAY

In fantastische neue Rollen schlüpfen.
Slipping into fantastic new roles.





Doctor Station | Dieses
Produkt finden Sie auf Seite 136/137
Doctor Station | You can find this
product on page 136/137





XXL PUPPENHAUS

Gleich einziehen und mit dem Dekorieren beginnen!
Move in right away and start decorating!

NEW!



Kids Video



DOLLHOUSE



44 TLG. | PCS.

24235

XXL PUPPENHAUS KINDERGARTEN SET

Gleich einziehen und mit dem Dekorieren beginnen! Das mehrstöckige Haus steht bereit für lustige Rollenspiele. Das Haus besteht aus sechs unterschiedlichen Zimmern, versetzbaren Treppen, einem Solarpanel auf dem Dach und einem großen bespielbaren Außenbereich.

XXL DOLLHOUSE KINDERGARTEN SET

Move in right away and start decorating! The multi-floor house is ready for funny role-playing games. The house consists of six different rooms, movable stairs, a solar panel on the roof and a large playable outdoor area.

Größe | Size: 900 x 600 x 734 mm

Boxgröße | Box size: 770 x 120 x 780 mm



MIT AUSSENBEREICH DURCH XL SPIELMATTE FÜR NOCH MEHR SPIELSPASS! WITH OUTDOOR AREA THROUGH XL PLAY MAT FOR EVEN MORE PLAY FUN



TEXTIL
TEXTILE

VIELE DETAILREICHE BESTANDTEILE!
MANY DETAILED COMPONENTS!

HIER KANN DAS EINRICHTEN DIREKT BEGINNEN
UND DIE PUPPEN KÖNNEN EINZIEHEN!
MOVE IN RIGHT AWAY AND START DECORATING!

MIT ABNEHMBAREN DACH | WITH ATTACHABLE ROOF



VOLL AUSGESTATTET
DIREKT LOSSPIELEN!

PLAY DIRECTLY
FULLY EQUIPPED!



In cooperation with Hape

Auto nicht inklusive
Car is not included
(E3475)



Kinderzimmer
children's room
Bad | bathroom
Schlafzimmer | bedroom
Küche | kitchen
Wohnzimmer
living room
Garten | garden





XXL CITY-PARKHAUS

Viele Spielmöglichkeiten für ein Rollenspiel!
Many different roleplay possibilities!



XXL CITY-PARKHOUSE

*OHNE FAHRZEUGE
WITHOUT VEHICLES



24230

XXL CITY-PARKHAUS

Egal ob parken, tanken, waschen, reparieren – das XXL City-Parkhaus von beleduc steckt voller Ideen und ist von allen Seiten bespielbar. Auf drei Ebenen können Autos in der Garage geparkt werden oder die Rampen in einem Rutsch hinunterflitzen oder es geht direkt von der Anfahrtsstraße auf einen der eingezeichneten Parkplätze. Der Aufzug, der über einen Seilzug bedient wird, befördert die Fahrzeuge auf die verschiedenen Parkhousebenen. Der Helikopterlandeplatz auf dem Dach des Aufzuges macht den Spielspaß komplett und die angesteckte, vordere Spielebene erhöht den Spielmehrwert und den Aktionsradius der Spielautos.

XXL CITY-PARKHOUSE

Whether you want to park, refuel, wash or repair your car – the XXL City-Parkhouse by beleduc makes it all possible and can be accessed from all sides. Three levels offer spaces to park your cars or cruise down different ramps. The lift, which is operated with a pulley, transports vehicles to the different parking levels. The helicopter landing zone on the roof of the lift completes the playing fun and the easily attachable street in front of the car park offers more play value and enlarges the play area for the cars.

Boxgröße | Box size: 730 x 220 x 545 mm



BIS ZU 5 KINDER
FINDEN PLATZ
UP TO 5 CHILDREN CAN
PLAY SIMULTANEOUSLY

MASSIVE HOLZBAUTEILE
MASSIVE HOLZBAUTEILE
**3 SPIELEBENEN VON ALLEN
SEITEN BESPIELBAR**
3 LEVELS ACCESSIBLE
FROM ALL SIDES

360°
FAHRZEUGAUFZUG MIT
DREHSCHRAUBE
LIFT FOR CARS OPERATED
BY ROTATING KNOB

TOLLE THEMEN-AUFDRUCKE
AUF JEDER EBENE
GREAT THEMED PRINTS
ON EVERY LEVEL



VERBESSERTE
BAUWEISE
IMPROVED
CONSTRUCTION

GRÖSSE | SIZE
915 x 700 x 600 MM



PLATZSPAREND ZU
VERSTAUEN DURCH GETEILTE
BASISPLATTEN
BASE PLATE IN 2 PARTS FOR
SPACE-SAVING STORAGE

OHNE FAHRZEUGE
WITHOUT VEHICLES



UNBEDINGT ANSCHAUEN!
I HAVE A LOOK!

Kids Video



4 IN 1 HAUSHALTS-CENTER

Kochen/Backen, Waschen, Bügeln + Hochsitz für die Puppe!
Cooking/baking, washing, ironing + high seat for the doll!

NEW!



**IM SET ENTHALTEN
INCLUDED IN THE SET**

- 3 Rezeptkarten · 3 Wäsche-Tipp-Karten · 1 Schürze · 1 Topfhandschuh · 1 Geschirrtuch · 1 Wäschekorb · 1 Bügeleisen · 1 Topf, 1 Pfanne, 1 Löffel, 1 Schneebesen · 4 Teller · Salz- und Pfefferstreuer · 2 Mülleimer aus Filz
- 3 recipe cards · 3 laundry tip cards · 1 apron · 1 oven glove · 1 dish towel · 1 laundry basket · 1 iron · 1 pot, 1 pan, 1 whisk, 1 spoon · 4 plates · Salt and pepper shakers · 2 felt bins



Kids Video

HOUSKEEPING CENTER



20 TLG. | PCS.

24236

HAUSHALTS-CENTER 4 IN 1

Kochen/backen, waschen, bügeln und vieles mehr kann am neuen mobilen Haushalts Center erledigt werden! An jeder Seite gibt es was zu entdecken: Kochecke mit Herdplatten und Backofen und tollen Rezeptkarten, herausziehbarer Hochstuhl und alles um die Puppe zu versorgen. Bügel- und Waschecke mit Bügeleisen und herausziehbarem Bügelbrett und Waschbecken. Mit zwei textilen Mülleimern, um für Ordnung zu sorgen. Hier sind der Kreativität keine Grenzen gesetzt und mehrere Kinder können zusammen spielen!

HOUSEKEEPING CENTER 4 IN 1

Cooking/baking, washing, ironing and much more can be done at the new mobile house-keeping centre! There's something to discover on every side: cooking corner with hot plates and oven and great recipe cards, pull-out high chair and everything to feed the doll. Ironing and washing corner with iron and pull-out ironing board and sink. With two textile bins to keep things tidy. There are no limits to creativity here and several children can play together!

Größe | Size: 800 x 680 x 480 mm



3 REZEPT- UND 3 WÄSCHE-TIPP-KARTEN ZUM EINSTECKEN
3 RECIPE AND LAUNDRY TIP CARDS TO INSERT

20 Teile
20 Pieces



MOBIL

LEICHT ZU ROLLEN
EASY TO ROLL

480 MM

800 MM

680 MM



MIT TOLLEN ACCESSOIRES
WITH GREAT ACCESSORIES



Mehr Zubehör
auf Seite 138
More accessories
on page 138

Lieferung ohne Dekoration. Änderungen vorbehalten.
Delivery without decoration. Changes reserved.





3 IN 1 DOCTOR STATION

*Kinderarzt, Tierarzt, Optiker und vieles mehr!
Paediatrician, Vet, Optician and much more!*



IM SET ENTHALTEN INCLUDED IN THE SET

- 6 Röntgenfolien · 3 Spielkarten /6 Motive · 1 Textil-Unterlage für den Tisch · 3 große Aktions-Charts (Kinder/Tiere) · 2 kleine Aktions-Charts
- 6 x-ray foils · 3 playing cards/6 motifs
- 1 textile underlay for the table
 - 3 large action charts (children/animals)
 - 2 small action charts

Lieferung ohne Dekoration.
Änderungen vorbehalten.
Delivery without decoration.
Changes reserved.



15 TLG. | PCS.

24232

DOCTOR STATION 3 IN 1

Die „Doctor Station“ lässt den Kindern viel Freiraum für kreatives und freies Rollenspiel. In welcher Rolle schlüpfst du? Ideal für den Kindergarten. Es kann von beiden Seiten bespielt werden und bietet zahlreiche Möglichkeiten, wie zum Beispiel Durchführung von Sehtests, Größe messen und Röntgenbilder anschauen. Die Kinder können sowohl Kinderarzt, als auch Tierarzt spielen, da die Karten ausgewechselt werden können. Hierbei können Plüschtiere und Puppen als Patienten genommen werden.

DOCTOR STATION 3 IN 1

The "Doctor Station" gives the children a lot of freedom for creative and free role play. Which role do you play? Ideal for the kindergarten. It can be played on from both sides and offers numerous possibilities, such as carrying out eye tests, measuring height and looking at x-rays. The children can play both paediatrician and vet, as the cards can be exchanged. Plush animals and dolls can be taken as patients.

Größe | Size: 1100 x 400 x 1120 mm

Boxgröße | Box size: 1200 x 580 x 110 mm



Kids Video

GEWICHTSSKALA ZUM EINSTELLEN | WEIGHTING SCALE WITH SLIDING SQUARES FOR MEASUREMENT



10 SPIELTHEMEN IN EINEM PRODUKT
10 THEMES IN ONE PRODUCT



RÖNTGENGERÄT ZUM DREHEN – BEIDSEITIG BESPIELBAR
X-RAY SCANNER: ROTATE IT BOTH SIDES FOR ROLE PLAY

MIT WECHSELBAREN KARTEN | WITH REMOVABLE CARDS



BEIDSEITIG BESPIELBAR | PLAYABLE ON BOTH SIDES



MIT DARSTELLUNG DER KÖRPER-ORGANE UND ERNÄHRUNGSPYRAMIDE
WITH ILLUSTRATION OF THE BODY ORGANS AND NUTRITION PYRAMID





PERFEKTE ERGÄNZUNG
ZUR DOCTOR STATION!
PERFECT COMPLEMENT
TO DOCTOR STATION!

7 Teile
7 Pieces



In cooperation with Hape

MIT MAGNETISCHEM GEMÜSE
WITH MAGNETIC VEGETABLES
KLETTVERSCHLÜSSE ZUM SCHNEIDEN
VELCRO FASTENERS FOR CUTTING
GEMÜSE, MESSER UND EIN SCHNEIDE-
BRETT, EIERKARTON
VEGETABLE, KNIFE AND A CUTTING
BOARD, EGG CARTON

Passend zum
Hauhalts-Center
Seite 135

Fits to the house-
keeping centre
on page 135



100 MM

140 MM

25 Teile
25 Pieces



MAGNET



NEW!



24233

DOKTOR-SET

Das Doktor-Set ergänzt die beleduc Doctor Station perfekt und stellt den Kindern alle Utensilien zur Verfügung, die sie für ein tolles Rollenspiel benötigen. Hat der kleine Teddy Schnupfen oder ist die Puppe hingefallen? Kein Problem. Mit dem Doktorkoffer können kleine Doktoren ihre Patienten sofort behandeln. Die realistisch anmutenden Instrumente wie Stethoskop, Fieberthermometer und weitere medizinische Utensilien kommen sogleich zum Einsatz. Mit diesem Arztkoffer gibt es nur noch glückliche Patienten.

DOCTOR ON CALL

The doctor set perfectly complements the beleduc Doctor's Table and provides children with all the utensils they need for realistic role play. Does the teddy have a cold or has the doll fallen down? No problem. With the doctor set, little doctors can treat their patients immediately. The instruments such as stethoscope, fever thermometer and other medical utensils look realistic and can be used immediately. With this doctor's set, there will only be happy patients.

Größe | Size: 210 x 80 x 150 mm



24237

KOCHGRUNDLAGEN + GEMÜSE, XL SET

Mit dem Kochgrundlagen und Gemüse Set macht gesunde Ernährung Spaß! Gemüse schneiden, Kartoffeln schälen und den Käse reiben – so macht das Zubereiten leckerer Gerichte Spaß! Das Gemüse wird von Klettverschlüssen oder Magneten zusammengehalten und lässt sich zerteilen. Der Eierkarton enthält 6 Eier – 3 hartgekochte Eier und 3 Spiegeleier, so macht Kochen Spaß!

COOKING ESSENTIALS + VEGETABLES, XL SET

With the cooking essentials and vegetables set tasty eating is fun! Cut the vegetables, peel the potatoes and grate the cheese - this is how preparing healthy meals is fun! The vegetables are kept together by Velcro fasteners or magnets and can be cut up. The egg box contains 6 eggs - 3 hard-boiled eggs and 3 fried eggs, so cooking is fun!

Boxgröße | Box size: 520 x 290 x 390 mm



DIE ORIGINAL HANDPUPPEN VON BELEDUC

THE ORIGINAL HANDPUPPETS BY BELEDUC



Die Handpuppen bieten den Kindern eine besondere Erfahrung, da sie selbst aktiv eine Geschichte mitgestalten können.

- Handpuppen sind ein effektives Mittel, die Aufmerksamkeit der Kinder zu halten
- Eignen sich perfekt für den Kommunikationsaufbau
- Fördern sprachliche, sozial-emotionale, kognitive und physische Bereiche

The handpuppets offer a special experience to the children since they allow them to actively participate in creating a story.

- Handpuppets are an effective tool to hold children's attention
- Perfectly suited for setting up communication.
- Promote linguistic, social-emotional, cognitive and physical skills

“ *In* fantastische neue **ROLLEN** schlüpfen! ”

für 35 Handpuppen, drehbar
for 35 handpuppets, rotating



70007 · HANDPUPPEN-DISPLAY
HANDPUPPET DISPLAY



40036 · BIENE | BEE



40034 · MARIENKÄFER
LADYBIRD



40280 · SCHMETTERLING
BUTTERFLY



40032 · RAUPE | CATERPILLAR



40277 · FROSCH | FROG



40255 · SPINNE | SPIDER



HANDPUPPEN

Die Handpuppen bieten den Kindern eine besondere Erfahrung, da sie selbst aktiv eine Geschichte mitgestalten können. Handpuppen sind ein effektives Mittel, die Aufmerksamkeit der Kinder zu halten und eignen sich perfekt für den Kommunikationsaufbau.

HANDPUPPETS

The handpuppets offer a special experience to the children since they can actively participate in the story. Handpuppets are an effective tool to hold children's attention and are perfectly suited for setting up communication.

3+ FOB

TIPP!

DETAILREICHE UMSETZUNG
VERY DETAILED REALISATION

NEUES MODERNES DESIGN
NEW MODERN DESIGN

KUSCHELIG-WEICHE QUALITÄT
CUDDLY-SOFT QUALITY

PÄDAGOGISCH WERTVOLL
PEDAGOGICALLY VALUABLE





40115 · ENTE | DUCK



40126 · HAHN | ROOSTER



40112 · HUHN | CHICKEN



40120 · SCHAF | SHEEP



40121 · PFERD | HORSE



40111 · KUH | COW



40124 · HASE | RABBIT



40113 · SCHWEIN | PIG



40030 · MAUS | MOUSE



40116 · HUND | DOG



40122 · KATZE | CAT



40110 · SCHILDKRÖTE | TURTLE



40038 · PANDA



40131 · PAPAGEI · PARROT



40123 · AFFE | MONKEY



40125 · BÄR | BEAR



40129 · KROKODIL
CROCODILE



40105 · T-REX



40118 · EULE | OWL



40250 · ISEL | HEDGEHOG



40114 · FUCHS | FOX



40130 · EICHHÖRNCHEN
SQUIRREL



40275 · KÄNGURU | KANGAROO



40128 · ELEFANT | ELEPHANT



40117 · TIGER



40119 · GIRAFFE



40127 · LÖWE | LION



MOM & BABY



MUTTER-KIND-HANDPUPPEN

Wenn die Muttertiere ihre Babys tragen und versorgen, können tolle Geschichten im kreativen Spiel entstehen. Für Kinder sind Handpuppen wirklich lebendig. Sie lachen herzlich über freche Fingerpuppen, lieben ihre Handpuppe und tauchen völlig ein in die Welt der Fantasie und erzählen Geschichten.

MOM & BABY HANDPUPPETS

When the mothers are carrying and caring for their babies, great stories can develop in creative play. Handpuppets are real to the children. They laugh about the cheeky fingerpuppets, love their handpuppets and submerge themselves in a world of fantasy and tell stories.

Größe | Size: 300 mm (Mutter | Mother)
150 mm (Baby)



FÖRDERN FANTASIE, SPRACHE UND SELBSTBEWUSSTSEIN DER KINDER
PROMOTES PHANTASY, LANGUAGE SKILLS AND THE CHILDREN'S SELF-CONFIDENCE

FÜR ERWACHSENEN- UND KINDERHÄNDE
FOR ADULT AND CHILDREN'S HANDS

KINDERGARTENQUALITÄT
KINDERGARTEN QUALITY



40450 · KÄNGURU | KANGAROO
»KANGA & JUJU«

40440 · AFFE | MONKEY
»CHEETA & BIBI«

40460 · KATZE | CAT
»CARA & MIMI«



XL AKTIONS-THEATER

MARKTSTAND/EISSTAND | MARKET STAND/ICE CREAM STAND



VORHANG AUF!
CURTAIN UP!

PRAKTISCHE
AUFBEWAHRUNGS-
TASCHE AUF DER
RÜCKSEITE
PRACTICAL STORAGE
NET ON THE REAR
SIDE



DEKORATION EINFACH
AN DEN HOLZKNÖPFEN
ZU BEFESTIGEN
EASY TO FIX THE
DECORATION ON THE
WOODEN KNOBS

BESCHREIBBARE
KREIDETAFLER
WRITABLE CHALK-
BOARD



24231

XL AKTIONS-THEATER

Mit dem Aktions-Theater aus Stoff und Holz können Kinder ihre kleinen Theaterstücke aufführen und in immer wieder neue Rollen schlüpfen. Das Theater ist mit einem roten Vorhang und einer großen Tafel ausgestattet, auf der Kinder notieren können, zu welcher Aufführung sie einladen, wann sie stattfinden wird und wann sie in der Hauptrolle auftreten werden, sowie eine praktische Aufbewahrungstasche für die Handpuppen auf der Rückseite. Das Aktions-Theater ist super-stabil und wird zerlegt geliefert (leichte Montage).

XL ACTION THEATRE

With our action theatre made from wood and textile, children can take on many different roles and perform them in their own play. The theatre includes a red curtains as well as a chalkboard on the front where the children can invite their audience to their performance, let them know when it takes place and what play they will star in. Furthermore, on the rear side there is practical storage net for the handpuppets and accessories. The Action Theatre is very stable and is delivered disassembled.

Größe | Size: 750 x 410 x 1200 mm



SCAN ME
Kids Video

VIELE KREATIVE
GESTALTUNGSMÖGLICHKEITEN
RUND UM DAS THEMA
MANY CREATIVE DESIGN OPTIONS
EXTREM STANDFESTE UND
STABILE KONSTRUKTION
EXTREMELY STABLE UND
DURABLE CONSTRUCTION



KINDER AUF DER BÜHNE | KIDS ON STAGE



Lieferung ohne Dekoration. Delivery without decoration.

STORY HANDPUPPETS



GESCHICHTEN-HANDPUPPEN

Alle treffen sich an einem schönen Sommertag, um gemeinsam zu picknicken. Dazu hat jeder etwas mitgebracht. Alle haben auch noch Freunde aus ihrer Umgebung eingeladen und zusammen haben sie einen tollen Nachmittag.

STORY HANDPUPPETS

All meet up on a nice summer day to have a picnic together. Everyone brought something. The group also invited friends and they spend a great afternoon together.



40411 MILA MOUSE AND FRIENDS

- 1 Maushandpuppe (fest am Käse),
- 2 Mäuse Fingerpuppen
- 1 mouse handpuppet (attached to the cheese),
- 2 mice fingerpuppets

Größe | Size: 260 x 260 x 330 mm



40421 MIKE MOLE AND FRIENDS

- 1 Maulwurfhandpuppe (fest an Erdhaufen),
- 2 Fingerpuppen (Regenwurm, Käfer)
- 1 mole handpuppet (attached to the molehill),
- 2 fingerpuppets (1 earthworm, 1 beetle)

Größe | Size: Ø 220 x 330 mm



40431 OTIS OWL AND FRIENDS

- 1 Eulenhandpuppe (fest am Baum),
- 2 Fingerpuppen (Glühwürmchen, Maus)
- 1 handpuppet owl (attached to the tree),
- 2 fingerpuppets (firefly, mouse)

Größe | Size: 150 x 170 x 330 mm



VERSENKBARE HAUPTFIGUR
INCL. 2 FINGERPUPPEN
RETRACTABLE MAIN FIGURE
INCL. 2 FINGERPUPPETS
HAND-WASCHBAR
HAND-WASHABLE
KINDERGARTEN-QUALITÄT
KINDERGARTEN QUALITY

Spiel unter Aufsicht eines Erwachsenen.
Play game only under adult supervision.



Kids Video

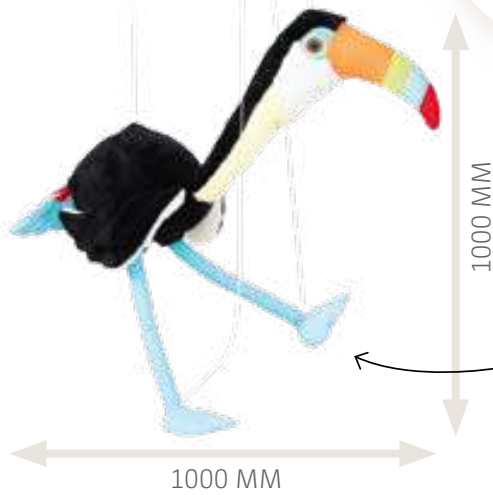

TOLLE DETAILS | GREAT DETAILS



42060

MARIONETTE „TUKAN TONI“

TONI, die freundliche Marionette hört den Abenteuern der Kinder gerne zu, tröstet sie, kuschelt und tanzt mit ihnen. Er ist der ideale Freund und Partner für Pädagogen, um das Unsichtbare sichtbar zu machen. Puppen fördern die nonverbale Kommunikation und erleichtern es Kindern, sich selbst zu öffnen. Toni ist auch das perfekte Maskottchen, kommt zu jedem Stuhlkreis zum Einsatz und kann jeden Kindertag aufhellen. Auch bei allen Geburtstagen und weiteren Feierlichkeiten ist er mit dabei. Die Marionette ist durch das Holzkreuz einfach zu bewegen und wird so „zum Leben erweckt“. Die Kinder werden Toni lieben. Der Tukan ist sehr detailreich gearbeitet, tolle kuschelige Qualität und fröhlich bunt.

STRING PUPPET „TOUCAN TONI“

Friendly Toni listens to the children's adventures, comforts them, cuddles and dances with them. He is the ideal tool for educators to make the invisible visible. Puppets promote non-verbal communication and make it easier for children to open up about themselves. Toni is also the perfect mascot and can brighten up every child's day. Children will love their new friend Toni. Skillfully using a string puppet takes some patience and practice. The toucan is very detailed and colourfully designed from high-quality materials for long-lasting playing fun.

Größe | Size: 1.000 × 1.000 mm



40318

PUPPETSHOW

8-teilig, ohne Display, Display einzeln erhältlich

Set of 8 puppets, without display, display available separately

Größe Puppen | Size puppets: 260 × 320 mm

Größe Krokodil | Size crocodile: 410 × 230 mm





24401

BUGGY

Der „Stabile“, mit dem nicht nur Puppen und Teddybären befördert werden können.

The “solid one”, not only suitable for carrying dolls and teddy bears.

Größe | Size: 420 x 360 x 600 mm

24 M+ FOB



EINEN WEITEREN BUGGY FINDEN SIE AUF SEITE 208

YOU CAN FIND ANOTHER BUGGY ON PAGE 208

STABILE STAHLACHSE
STURDY STEEL AXLE



BESONDERS GUTE REIFENQUALITÄT
EXCEPTIONALLY GOOD TYRE QUALITY

SUPER STABIL UND MASSIV AUS HOLZ
SUPER STURDY AND LONG-LASTING

BIS 100 KG BELASTBAR!
DURABLE UP TO 100 KG!



42045

OSCAR

Der Igel Oscar möchte gern, dass ihr mehr über ihn erfahrt. Was frisst Oscar gern, wo lebt er und wann ist er aktiv? Ganz nebenbei könnt ihr aber auch seine bunten Stacheln abnehmen und anheften, die braunen Stacheln herausziehen und wieder hineinstecken, seine Geräusche erklingen lassen oder auch einfach nur mit ihm kuscheln.

Oscar the hedgehog invites you to learn more about him. What does Oscar like to eat, where does he live, and when is he out and about? And while you are learning about him you can also take off the coloured spines and fix them on again, pull out and push in the brown spines, activate the sounds he makes – or just cuddle him.

Größe | Size: ø 665 x 310 mm

24 M+ 1+ 15 FOB

Praxis-
Begleitbuch
rund um den Igel

Practical Guide Book
all around the
hedgehog



STICKEREI AM BAUCH ZEIGT
IGEL-SPEISEPLAN
EMBROIDERY ON UNDERSIDE
SHOWS HEDGEHOG-MENU





SAND & BEWEGUNG

SAND & MOVEMENT

Erlebnisse, Spiel & Spaß im Außenbereich.
Open-air Adventures, Fun and Games.





BEWEGUNG

Laufen, Werfen, Zielen, Springen...Kinder haben einen natürlichen Bewegungsdrang, den sie mit oder ohne Hilfsmittel ausüben wollen. Durch einfache Abläufe und Übungen werden Körperbewusstsein, Koordinationsvermögen, Gleichgewichtssinn und Raumerfahrung geschult. Wichtig ist, dass den Kindern Spaß an Bewegung vermittelt wird und sie so ausdauernd aktiv sind.

MOVEMENT

Running, throwing, taking aim, jumping... children have a natural urge to move, which they want to realize with or without any tools. With the help of easy exercises children learn about body awareness, coordination ability, sense of balance and space. It is important that children experience the joy to move so they can stay persistent in their activity.



Stepping Stones | Diesen Artikel finden Sie auf Seite 154/155
Stepping Stones | You can find this product on page 154/155



PUNKTE WERFEN | POINT-THROWING



67110

JUMP & THROW

Die zehn bunten Ringe können beliebig zu einem gewünschten Parcours angeordnet werden und sind für viele Spielarten zu verwenden. Ob nacheinander, im Kreis angeordnet, dicht beieinander oder weiter auseinander positioniert – die Hüpfstrecke kann überall aufgebaut werden. Drei Wurfsäckchen ergänzen das Produkt und ermöglichen noch mehr Vielfalt und Spielspaß.

The ten colourful rings can be arranged to form any chosen course and can be used in many variations. Whether positioned one after the other, in a circle, close together or further apart – the jumping track can be set up anywhere. Three bean bags complete the product and allow for even more fun & versatility.

Netzgröße | Size of net: 320 x 320 x 25 mm



INKL. ANLEITUNG MIT VIELEN SPIELIDEEN
INCL. MANY GAME INSTRUCTIONS

INDOOR UND OUTDOOR NUTZBAR
FOR INDOOR AND OUTDOOR USE

INKL. 3 WURFSÄCKCHEN
INCL. 3 BEAN BAGS



24-SEITIGES ANLEITUNGS-
HEFT MIT 8 SPIELIDEEN
INCL. MANY GAME INSTRUCTIONS

WEICHE SOFT-GRIFFE UND BÄLLE
SOFT HANDHOLDS AND BALLS

INDOOR UND OUTDOOR NUTZBAR
FOR INDOOR AND OUTDOOR USE

3 BÄLLE INKLUSIVE
INCL. 3 BALLS

Ø
310 MM



67080

NET BALL

Die beiden Handtrampoline können für ein lustiges Rückschlagspiel genauso wie für eine Einzelbeschäftigung genutzt werden.

The two hand trampolines can be used as a funny game throwing the ball back and forth as well as for individual playing.

Netzgröße | Size of net: 310 x 340 x 40 mm



BALANCE BOARD 2 IN 1



*Balance und Koordination sind gefragt!
Balance and coordination are required!*

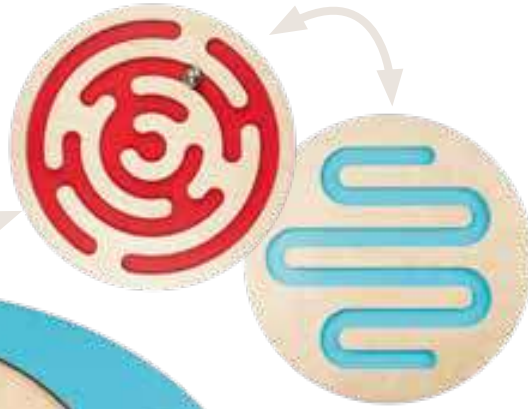

DIE INNERE PLATTE
IST HERAUSNEHMBAR!
THE INNER DISC
IS REMOVABLE!

BESONDERS ANSPRECHENDES DESIGN
VERY APPEALING DESIGN

HOCHWERTIG AUS HOLZ GEFERTIGT
HIGH-QUALITY MADE FROM WOOD

ES KÖNNEN GLEICHZEITIG 2-3 KINDER SPIELEN
2-3 CHILDREN CAN PLAY SIMULTANEOUSLY

← 495 MM →



67130

BALANCE BOARD

Das Balance Board kombiniert Spiel, Spaß und Bewegung. Durch geschickte Gewichtsverlagerung werden die Kugeln durch unterschiedliche Bahnen entlang geführt. Die abnehmbare Spielscheibe kann ebenso mit den Händen gesteuert werden und sorgt für neue Herausforderungen und zusätzlichen Spielspaß.

The balance board combines playing, fun and exercise. By skillfully shifting your weight, the balls are guided along different tracks. The removable game disc can also be controlled with your hands, providing new challenges and more fun.

Größe | Size: 495 × 370 × 55 mm





**4ER SET
SET OF 4**



67050

BÄLLE, 4ER SET SET OF 4 BALLS

Durch ihre griffige Oberfläche lassen sich diese Bälle besonders gut von Kinderhänden greifen.

Due to their maximum grip surface children can easily grab them with their hands.

Größe | Size: Ø 250 mm, Ø 210 mm,
Ø 170 mm, Ø 120 mm

Ø
230 MM



53120

AUFBLASBARER »SUPER-SOFTBALL« INFLATING »SUPER SOFT BALL«

Ideal für alle Ballspiele und Übungen geeignet.
Perfect for all ball games and exercises.

Größe | Size: Ø 230 mm



BÄLLE

Die kleinen und großen Bälle sind perfekt für kleine Kinderhände in der Gruppe, im Garten oder Sandkasten geeignet.

BALLS

These little helpers fit perfectly to small childrens hands by playing in the group, in the garden or in the sandbox.

3+ !1



Ø
100 MM

40721

MASSAGEBÄLLE, 25ER SET SET OF 25 MASSAGE BALLS

Inkl. Pumpe. | Incl. pump.

Größe | Size: Ø 100 mm



**5ER SET
SET OF 5**

+ POSTER UND BEGLEITHEFT MIT
VIELEN ÜBUNGEN ZUM NACHMACHEN
+ POSTER AND ACCOMPANYING BOOKLET
WITH MANY EXERCISES TO IMITATE

FÜR DIE UNTERSCHIEDLICHEN AUFGABEN
KANN DIE LUFT MITTELS EINGEBAUTEM
VENTIL REGULIERT WERDEN
FOR THE DIFFERENT TASKS THE AIR CAN
BE REGULATED WITH AN INTEGRATED VALVE



500g

700g

900g

1100g

1300g



67061

MULTI MOVES

Sandbälle mit unterschiedlichen Gewichten laden Kinder zum Schätzen, Balancieren, Massieren und Werfen ein. So wird spielerisch die Motorik und Koordination gefördert.

Sand balls with different weights invite children to estimate, balance, massage and to throw them. This helps to foster motoric skills and coordination in a playful way.

Größe | Size: Ø 95 mm

3+ 1+ 6



67200

MAGIC DRIVING CAR

Dieses Fahrzeug sieht nicht nur toll aus, es macht auch unglaublich viel Spaß! Kinder entdecken eine andere Art der Fortbewegung mit dem Antrieb durch die Lenkbewegung. Das neue Auto überzeugt durch seine kompakte und somit wendige Form. Durch die Bewegung des Lenkrads nach rechts und links bewegt sich das Magic Driving Car vorwärts. Wird das Lenkrad um 180 Grad gedreht, geht es rückwärts weiter. Der Fahrzeug-Korpus ist geschlossen und somit sehr stabil. Die hochwertigen Rollen haben einen Durchmesser von 90mm.

Our magic driving car is not only an eye-catcher but also provides amazing driving fun! This car convinces due to its compact and agile form. It moves forward when turning the steering wheel left and right and can also drive backwards by turning the wheel 180 degrees. The corpus is closed and therefore very stable. The high-quality wheels have a diameter of 90 mm.

Größe | Size: 690 x 290 x 370 mm



3+

HOCHWERTIGE GUMMIREIFEN | HIGH-QUALITY TIRES



Überraschend andere Art der Fortbewegung!

Surprising different kind of movement

SPASS & KOORDINATION IN EINEM
COMBINES FUN AND COORDINATION

VÖLLIG NEUES FAHRERLEBNIS
NEW, INNOVATIVE WAY OF DRIVING



SCAN ME
Kids Video



SELBSTÄNDIGE FORTBEWEGUNG DURCH LENKBEWEGUNG
USE WHEEL MOVEMENT TO CREATE DRIVING FORCE

ROBUSTER UND GESCHLOSSENER KORPUS
ROBUST AND CLOSED BASE

690 MM

370 MM



STEPPING STONES

Für kleine und große Hüpfher!
Jumping fun for everyone!

TIPP!



INKLUSIVE UMFANGREICHER SPIELANLEITUNG
(26 SEITEN) MIT SPIELIDEEN
INCLUDING COMPREHENSIVE INSTRUCTIONS
(26 PAGES) WITH DIFFERENT GAME IDEAS





13 TLG. | PCS.

67140

STEPPING STONES - SET

Den Spieleklassiker „Hüpfkästchen“ lieben alle Kinder und besonders viel Spaß machen die „Stepping Stones“, denn hier warten viele Klassiker aber auch viele neue Ideen. Die Hüpfmatten, in den 2 tollen Farben sind qualitativ besonders strapazierfähig und sowohl für drinnen und draußen geeignet. Sogar in Kombination mit Zahlen. Während die Kleinen fröhlich auf der Matte herumhopsen, auf einem Bein springen, balancieren und vieles mehr, werden dabei spielerisch die motorischen Fähigkeiten des Kindes gefördert. Die bunten Sitzkissen ermuntern Kinder sich zu bewegen und sorgen für zusätzlichen Spaß, wenn es im Bewegungsparcours so richtig rund geht. Inklusive 26-seitigem Anleitungsheft.

All children enjoy fun movement games and can playfully train their motor skills when balancing and jumping around. Our exciting "Stepping Stones" set comes with 6 high-quality air cushions and 6 robust rubber mats including instructions (26 pages) with many game ideas. The aircushions and non-slip rubber mats in different colours motivate the children to move. The set is very durable and can be used indoors and outdoors. Additional numbers on the mats offer many different game possibilities and add another fun element to the parcourse.

Größe | Size: 340 x 340 x 370 mm



67150

BALANCIER-/SITZKISSEN - EINZELN

In 3 Farben (orange, grün, blau) , gemischt gepackt.

SEAT CUSHIONS - SINGLE

In 3 colours (orange, green, blue) mixed packed.

Größe | Size: 340 x 340 x 60 mm

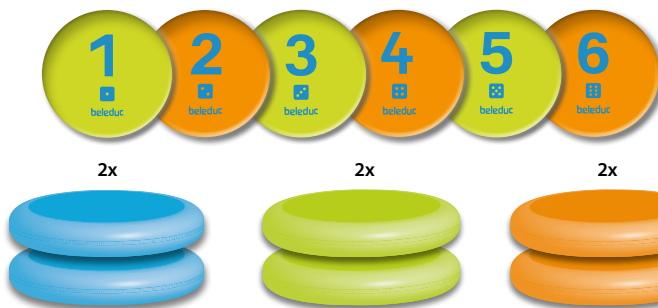

SET

6 Luft-Kissen
6 air cushions



NOPPEN REGEN DIE SENSORISCHEN NERVEN DER FUSSSOHLEN AN
BUMPS STIMULATE THE SENSORY NERVES ON THE SOLES

VERSCHIEDENE NUTZUNGSMÖGLICHKEITEN:
SITZUNTERLAGE, GLEICHGEWICHTSTRaining,
STÄRKUNG DER RÜCKEN- UND FUSS-
MUSKULATUR, KOORDINATIONSTRaining
DIFFERENT FUNCTIONS:
SEAT CUSHION, BALANCE TRAINING,
STRENGTHENS BACK AND FOOT MUSCLES,
COORDINATION TRAINING



FÜR DIE GRUPPE GEEIGNET!

INDOOR- & OUTDOOR

SUITABLE FOR GROUP PLAY!

INDOOR- & OUTDOOR

6 RUTSCHFESTE GUMMIMATTEN
6 NON-SLIP RUBBER MATS

6 WEICHE SITZKISSEN
6 SOFT CUSHIONS

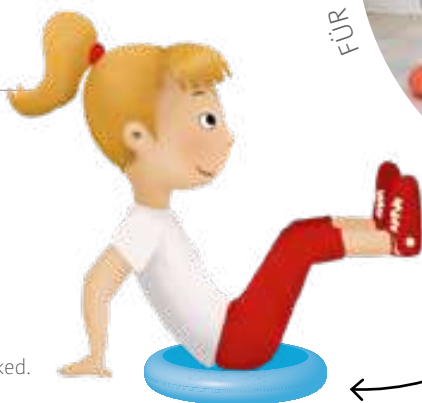

Katrin Schulte

Physiotherapeutin, Deutschland
Physiotherapist, Germany

„Großartig auch im Therapiebereich getestet!
Ideal auch für Absprungübungen, Vorgabe von individuellen Schrittlängen und Konzentrationsübungen durch Bewegungsabfolgen. Einfach im Handling, nutzbar auch auf schrägen Ebenen - viele Interpretationsspielräume.“

„Tested and approved for therapeutic use as well.
Ideal also for jumping exercises, specification of individual stride lengths and training concentration through motion sequences. Easy to use even on slanting surfaces - this item offers much room for interpretation.“



- Maximal Luft, ca. 15-16 cm Höhe; Anspruchsvolles Balancieren
Maximum air, height appr. 15-16 cm; For ambitious balancers
- Mehr Luft, ca. 7-8 cm Höhe; Balancieren für Geübte
More air, height appr. 7-8 cm; Advanced balancing
- Wenig Luft, ca. 5-6 cm Höhe; Leichtes Balancieren
Little air, height appr. 5-6 cm; Balancing for beginners



**BEST
SELLER**

100 kg



*Fahrzeug mit
robuster Stahlachse*

*Truck with sturdy
steel axle*



66000

GROSSER TRUCK

Der Große Truck begeistert Groß und Klein! Die Kleinsten können diesen tollen Truck als Lauflernwagen verwenden. Für die Größeren ist er ein toller Gefährte im Sandkasten. Der große und stabile Truck kann problemlos mit bis zu 100 kg beladen werden.

GIANT TRUCK

The Giant Truck inspires both young and old. The youngest children can use this great truck as a walker. For older children it is a fantastic companion in the sandbox. The big and solid truck can be loaded with 100 kilograms of weight without any problems.

Größe | Size: 620 × 390 × 360 mm

24
M+

FOB





66010

DUMPER

Der große Dumper bringt Baustellenatmosphäre für vielfältige Sandspiele. Dank seiner stabilen Stahlachsen und seines beständigen Kunststoffmaterials ist eine Belastung von bis zu 50 kg möglich. Das Entladen der Sandfuhr wird dank der 90°-Kippfunktion zum Kinderspiel.

The big Dumper brings a construction site atmosphere for various playing activities in the sand. Thanks to its hardened steel spindles and firm plastic material, loadings up to 100 kilograms can be transported. The 90° dumping function makes unloading sand loads a mere child's play.

Größe | Size: 650 × 415 × 400 mm

18 M+ FOB

Fahrzeug mit robuster Stahlachse
Truck with sturdy steel axle



50 kg

90° KIPPFUNKTION
90° DUMPING FUNCTION





BELEDUC SAND SETS



32 TLG. | PCS.

92258

1 SAND SET „STABIL“ | “STABLE”

Unser Sand-Set „Stabil“ umfasst die wichtigsten Sandprodukte für höchste Beanspruchung im Kindergarten. | Our Sand Set „Stable“ includes the most important sand products for the highest usage in kindergartens.

- 4 Sandschaufeln | sand shovels, 55 cm
- 4 starke Schaufeln | strong shovels, 40 cm
- 8 Siebe | sieves
- 8 Eimer | buckets
- 8 Mehlschaufeln | flour shovels



- Beste Kindergarten Qualität
 - Robust und langlebig
 - 5 Jahre Garantie
-
- Best kindergarten quality
 - Robust and long-lasting
 - 5 years warranty

25 TLG. | PCS.



92259

2 SAND SET „SPEZIAL“ | “SPECIAL”

Das Sand-Set „Spezial“ bietet außergewöhnliche Möglichkeiten. Walze den Sand, erschaffe Straßen, grabe mit der Power-Klaue, experimentiere mit den neuen Regenschaukeln und entdecke die einzigartige Sand- und Wassermühle mit der einstellbaren Trichteröffnung.

The Sand Set „Special“ offers extraordinary possibilities. Roll the sand, create roads, dig with the power claw, experiment with the new rain shovels and discover the unique sand and water mill with the adjustable funnel opening.

- 2 Monsterbagger | monster diggers
- 2 Sand- & Wassermühlen | sand & water mills
- 8 Power-Krallen | power claws
- 8 Regenschaukeln | rain shovels
- 5 Strukturröller | structure rollers

50 TLG. | PCS.



92280

3 SAND SET „FORMEN UND BAUEN“ | “FORMING & BUILDING”

Die 50 beliebtesten Accessoires für Kreativität im Sand! Klassische Formen, Baumeister Zubehör sowie Backstube und Eisdiele unterstützen die gestalterische Freiheit als auch das Rollenspiel!

The 50 most popular accessories for creativity in the sand! Classic shapes, master builder accessories for creativity in the sand! Classic shapes, master builder accessories, bakery and ice cream shop support creative freedom as well as role play!

- 10 tlg. Backstuben Set | 10 pcs. Bakery set
- 16 tlg. Eisdiele Set | 16 pcs. Ice cream shop set
- 6 tlg. Maurermeister Set | 6 pcs. Master bricklayer set
- 8 Förmchen Fahrzeuge | 8 moulds vehicles
- 10 Förmchen Meerestiere | 10 moulds sea animals



5 Jahre Garantie
5-YEAR WARRANTY

UV Beständig
NO BLEACHING

Phthalatfrei
PHTHALATE-FREE



107 TLG. | PCS.

92303

SAND SET „GLÜCKLICHE BAUMEISTER“ | “HAPPY BUILDERS”

Set „Spezial“, „Stabil“ und „Formen & Bauen“ | Set „Special“, „Stable“ and „Forming & Building“

- 8 Spaten/spades
- 8 Siebe/sieves
- 2 Monsterbagger/monster diggers
- 8 Power-Krallen/power claws
- 5 Strukturroller/structure rollers
- 16 tlg. Eisdielen-Set/16 pcs. Ice cream shop set
- 8 Förmchen Fahrzeuge/molds vehicles
- 8 Mehlschaufeln/flour shovels
- 8 Eimer/buckets
- 2 Sand- & Wassermühlen/sand- & water mills
- 8 Regenschaukeln/rain shovels
- 10 tlg. Backstuben-Set/10 pcs. Bakery set
- 6 tlg. Baumeister-Set/6 pcs. Builder set
- 10 Förmchen Meerestiere/molds sea animals





SANDSPIELZEUG

Mit unseren hilfreichen Sandfahrzeugen wird es einfacher kleine Türme zu bauen oder tiefe Löcher zu graben. Die Stahlachsen sorgen für extra Stabilität und die leisen EVA-Reifen hinterlassen tolle Spuren in Sand und Schnee.

SANDTOYS

Digging and roadwork fun with our sandtoys. The steel axles ensure extra stability and the quiet EVA tyres leave real tracks in the sand and in the snow.

18
M+

FOB



66030 • KIPPLASTER | TRUCK

Der Kipplaster ermöglicht es Sand und Schnee schneller zu transportieren. Er besteht aus stabilem UV-beständigen Kunststoff.

The truck enables children to transport sand or snow in an easy way. The truck is made of durable UV resistant plastic.

Größe | Size: 310 × 210 × 195 mm



66080 • RADLADER | LOADER

Mit seiner beweglichen Schaufel wird das Schaufeln von Sand kinderleicht. Die Stahlachsen sorgen für extra Stabilität.

With its movable shovel, sand digging becomes a mere child's play. The steel axles ensure extra stability.

Größe | Size: 420 × 180 × 280 mm



66100 • SANDBAGGER | DOZER

Mithilfe der großen Schaufel, können größere Mengen an Sand ganz einfach geschoben und zur gewünschten Stelle transportiert werden.

With the big shovel of the Dozer, large amounts of sand can be easily moved and transported to the desired spot.

Größe | Size: 370 × 255 × 195 mm



66110 • SANDWALZE | ROLLER

Die Sandwalze hilft dabei, Sandflächen zu ebnet. Auf diese Weise können Kinder viele neue kreative Ideen entwickeln.

The Roller helps to flatten sand areas. In this way the children can develop many new creative ideas.

Größe | Size: 350 × 255 × 185 mm



66060

MULTISCHAUFEL

Die stabile Schaufel eignet sich nicht nur für das Graben im Sand, sondern auch zum Schneeschaufeln im Winter. 3 Farben, gemischt gepackt.

MULTI SHOVEL

The durable shovel is not only ideal for digging in the sand, but also for shovelling snow in the winter. 3 colours, mixed packed.

Größe | Size: 150 x 80 x 715 mm



DAS ORIGINAL VON BELEDUC
THE BELEDUC ORIGINAL



EXTREM STABIL
EXTREMELY STURDY

WEITERE
INTERESSANTE
PRODUKTE AUF
SEITE 215
—
MORE INTERESTING
PRODUCTS ON
PAGE 215

MIT FUNKTION ALS SPATEN
WITH FUNCTION AS A SPADE



5 JAHRE GARANTIE
5-YEAR WARRANTY

KEIN AUSBLEICHEN
NO BLEACHING

PHTHALATFREI
PHTHALATE-FREE



66090

EIMER, TRANSPARENT

Der transparente Eimer verfügt über ein Fassungsvermögen von 1,5 l. Er lädt nicht nur zum Sandturmchen bauen ein, sondern führt Kinder ebenfalls spielerisch an das Erkunden und Entdecken von Wassermengen und -volumina heran.

BUCKET, TRANSPARENT

The transparent bucket has a capacity of 1.5 l. It does not only invite children to build sandcastles, but also introduces them to exploring and discovering water amounts and capacities in a playful way.

Größe | Size: Ø 160 × 165 mm



66040

SANDSCHAUFEL

Die stabile Sandschaufel verfügt über einen handlich geformten Griff. Auf diese Weise macht das Graben im Sand und das Bauen von Sandburgen noch mehr Spaß. 3 Farben, gemischt gepackt.

SAND SHOVEL

The durable sand shovel has an ergonomic handle. In this way, digging in the sand and building sand castles is even more fun now! 3 colours, mixed packed

Größe | Size: 240 × 80 × 80 mm

66070

EIMER

Der Eimer ist dickwandig und dennoch sehr flexibel. Mit einer Skala bis zu 1,25 l und einem Ausguss bietet er nicht nur Spaß im Sandkasten, sondern eignet sich auch für Wasserspiele. 2 Farben, gemischt gepackt.

BUCKET

The bucket is thick-walled and yet very flexible. With a scale up to 1.25 l and a pouring spout it offers not only fun in the sand, but is also suitable for water games. 2 colours, mixed packed.

Größe | Size: Ø 160 × 140 mm





66020

TRAKTOR MIT ANHÄNGER

Der Traktor mit Anhänger ist ein toller Begleiter für den Sandkasten. Der Anhänger ist abnehmbar und verfügt über eine Kippfunktion, die das Be- und Entladen von Sand erleichtert. Sowohl Traktor als auch Anhänger bestehen aus stabilem UV-beständigen Kunststoff. Die Stahlachsen sorgen für extra Stabilität und die leisen EVA-Reifen hinterlassen tolle Spuren in Sand und Schnee.

TRACTOR WITH TRAILOR

The Tractor with Trailer is a great companion for the sandbox. The trailer is removable and has a tilt function, which facilitates loading and unloading the sand. Both Tractor and Trailer are made of durable UV resistant plastic. The steel axles ensure extra stability and the quiet EVA tyres leave real tracks in the sand and in the snow.



Größe | Size: 550 x 160 x 155 mm



66050

STRUKTURROLLER, 5ER SET

Mit den Strukturrollern ist es möglich, Straßen zu formen oder Sandburgen mit Mustern zu verzieren. So lassen sie den Kindern viel Freiraum für Kreativität.

SET OF 5 TRACK ROLLERS

With the Set of 5 Track Rollers it is possible to form streets or embellish sandcastles with patterns. Thus, children can enjoy much room for creativity.

Größe je | Size each: 145 x 180 x 80 mm



TOPLINE



Bewegung & Spaß in der freien Natur!

Movement & fun in the great outdoors!

Die beleduc TopLine bestehend aus den Fahrzeugen von TopTrike und den neuen Outdoor-Produkten von TopPlay für das kreative Rollenspiel.

Das 'draußen Spielen' ist wichtiger denn je und bei den neuen TopPlay Produkten liegt unser Fokus genau dort. Mit Kindern die Natur entdecken und sich an der frischen Luft bewegen. Im Freien macht Spielen und Lernen noch mehr Spaß und es entstehen häufig neue Spielideen, ganz frei und kreativ. Bewegung macht Spaß und ist wichtig für gesunde und aktive Kinder. Mit den innovativen Fahrzeugen der TopTrike Linie fördern wir auf spielerische Weise die Motorik und integrieren Sport und Spiel in den Alltag.

The beleduc TopLine consists of the vehicles from TopTrike and the new outdoor products from TopPlay for creative role play.

'Playing outside' is more important than ever and with the new TopPlay products this is our focus.

Discovering nature with children and being active in the fresh air. Playing and learning is even more fun outdoors and new play ideas often come up, quite freely and creatively. Movement is fun and important for healthy and active children. With the innovative vehicles of the TopTrike line, we promote motor skills in a playful way and integrate sports and play into everyday life.

Kinder bestmöglich fördern heißt heute: Anreize, Ideen und kreative Produkte erschaffen, die Spielen und Lernen optimal miteinander verknüpfen und dabei riesig viel Spaß machen.

Supporting children in the best possible way today means: Creating incentives, ideas and creative products that combine playing and learning in the best possible way and are a lot of fun at the same time.

*Neue Ansätze
am Puls der Zeit!*

*New concepts
on the pulse
of time!*





Innovationen im Bereich Rollenspiel und Fahrzeuge Innovations in role play and vehicles

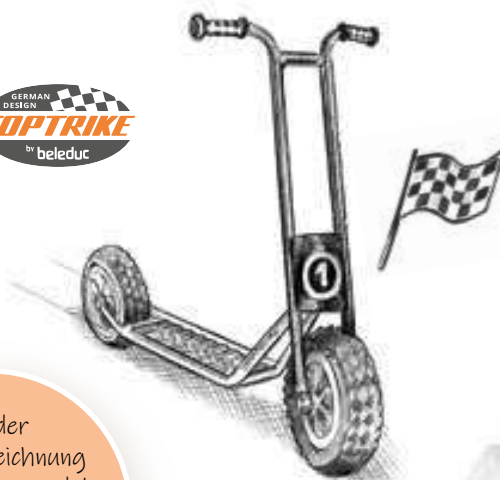

Von der
ersten Zeichnung
zum fertigen Produkt
From the first
sketch to the final
product



„Für mich ist es wichtig, dass ein Spielzeug immer einen klaren Aufforderungscharakter hat und selbsterklärend ist. Ganz besonders freut es mich, wenn Kinder auf natürliche Weise dazu animiert werden, sich draußen in der freien Natur zu bewegen und ihre Fantasie dazu benutzen, neue Spielmöglichkeiten zu entdecken.“



Ansgar Honkomp, Senior Designer beleduc

“For me it’s important that a toy always has a clear challenge character and is self-explanatory. I am very happy when children are naturally encouraged to move outside in nature and use their imagination to discover new ways to play.”



TOPTRIKE

Mit den tollen TopTrikes ist Fahrspaß garantiert!
Driving fun is guaranteed with great TopTrikes!





NEW!

Maxi-Roller XL | Diese Neuheit
finden Sie auf Seite 186/187
Maxi Roller XL | You can find this
novelty on page 186/187



KINDERFAHRZEUGEXPERTE SEIT MEHR ALS 25 JAHREN

THE EXPERT FOR CHILDREN'S VEHICLES FOR OVER 25 YEARS



Wir unterstützen Kinder gezielt dabei, ihren Bewegungsdrang mit unseren Fahrzeugen auszuleben. Dabei werden ganz nebenbei motorische Fähigkeiten und das Durchhaltevermögen der Kinder gefördert.

By using our vehicles we support the children's urge to move. Incidentally the child develops motor skills and endurance.



Prof. Dr. Harald Lange, Deutschland / Germany

„Wir haben ein Qualitätssiegel zur Bestimmung des Bewegungs-, Lern- und Spielwerts von Bewegungsgeräten entwickelt, um Sportlern, Eltern, Lehrern, Trainern und anderen Anwendern eine ebenso handhabbare wie treffsichere Orientierung für die Auswahl, den Kauf und die Anwendung anzubieten.“

“We have developed a quality seal to measure the movement, educational and play value of our movement items. This gives parents, teachers, trainers, athletes and other users a practical and precise help for making choices regarding purchasing and usage.”



Das Qualitätssiegel „Bewegte Innovation“ zeichnet Produkte mit hoher bewegungspädagogischer Qualität und hohem Innovationsgehalt aus.

The quality seal “Bewegte Innovation” (= “Moving Innovation”) is awarded to items with high pedagogical quality regarding movement and innovation.

HIGHLIGHT!



DIE BELEDUC TOPTRIKE GARANTIE UND QUALITÄTSMERKMALE AUF EINEN BLICK:



OUR TOPTRIKE GUARANTEES AND QUALITY FEATURES AT A GLANCE:

- **Entwickelt mit einem Team aus führenden Pädagogen, Ingenieuren und Produktdesignern**
Developed with a team of leading pedagogues, engineers and product designers
- **Wissenschaftlich getestet**
Scientifically proven
- **Einfache Montage**
Easy assembling
- **Lenkeinschlag und Anschlagdämpfer verhindern Einklemmen der Finger**
Limited steering angle and stop damper avoid trapping of fingers
- **Robuster, pulverbeschichteter Rahmen gegen Rost und Stöße resistent**
Solid, powder-coated frame resistant to rust and impacts
- **Langer, stabiler und wetterfester Kunststoff Sitz passend für verschiedene Altersgruppen**
Long, solid and weather-proof plastic seat suitable for different age groups

- **Umfassender Ersatzteil-Service**
Broad spare part service
- **5 Jahre Garantie auf den Rahmen**
5 years warranty on steel frame
- **1 Jahr Garantie auf alle beweglichen Teile**
1 year warranty on all moving parts
- **Für Kinder von 3 – 10 Jahren**
For children aged 3 – 10 years
- **Bis 50 kg**
Up to 50 kg

Eine Übersicht der Ersatzteile finden Sie auf S. 253–257.
Find an overview of the Spare Parts on P. 253–257.

Räder mit geschlossenem, dauergeschmierten Industriekugellager für leichtes Fahren
Wheels with sealed, permanently greased industrial bearings for an easy-going ride



Hochwertige, massive Achse aus gehärtetem Stahl
High-quality axle made of solid hardened steel

Spezialpedale mit Gumminoppen verhindern ein Abrutschen der Füße
Special pedals with rubber nubs avoid slipping off of the feet



Robuste Handgriffe mit Gumminoppen für soliden Halt
Solid handle with rubber nubs for a good grip



Starker Metallrahmen mit 22 mm Durchmesser
Heavy steel frames with a diameter of 22 mm

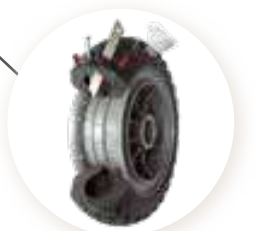

Durchgeschäumte EVA-Reifen für lange Lebensdauer und leises Fahren
EVA-foamed tyres for long life durability and quiet cruising



für die Kleinsten
for the youngest



64300

LITTLE DRIVER

Das erste Rutsch-Fahrzeug für die Kleinsten. Hiermit erlernen Kinder ab 12 Monaten die ersten Bewegungsabläufe und verbessern die motorischen Fähigkeiten und schaffen somit die Grundlage für komplexe Abläufe und erfolgreiches Lernen.

With this ride-on bike children aged 12 months and older can practice first motor sequences and thus improve their motor skills. This builds the base for the successful learning of more complex motion sequences.

Größe | Size: 540 × 210 × 370 mm
Boxgröße | Box size: 540 × 220 × 310 mm

12
M+

FOB

3,9kg

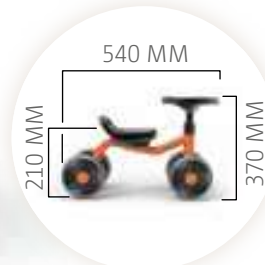

64310

LITTLE CRUISER

Mit dem kleinen Dreirad kann direkt losgefahren werden. Hier üben die Kleinsten die Koordination beim Treten und gleichzeitigen Lenken. Der integrierte Griff im Sitz ermöglicht ein einfaches Handling.

Ride along with our "Little Cruiser"! This trike is perfect for small children to learn to coordinate pedalling and steering at the same time. The seat has an integrated handle which makes it easier to carry and store.

Größe | Size: 660 × 410 × 500 mm
Boxgröße | Box size: 560 × 200 × 455 mm

18
M+

FOB

4,3kg



TIPP!



ABRIEBFESTE RÄDER
ABRASION RESISTANT
WHEELS





64320

LITTLE BALANCER

Das Laufrad für die Kleinsten – damit geht es los. Hier können Kinder schon sehr früh ihren Körperschwerpunkt entdecken und das Gleichgewicht trainieren. Der verstellbare Sitz ist individuell auf die Kinder einstellbar. Laufräder sind die ideale Vorstufe zum Fahrradfahren.

Hop onto the walking bike "Little Balancer" for the youngest. With this bike young children can discover their body's centre of gravity and train their balance. The seat can be individually adjusted for each child. Walking bikes are the ideal preparation for riding a bike.

Größe | Size: 730 x 440 x 495 mm
Boxgröße | Box size: 660 x 150 x 310 mm



RÄDER LAUFEN LEICHT
DURCH GERINGEN ABRIEB
ABRASION-RESISTANT
WHEELS FOR LITTLE
FRICTIONAL RESISTANCE



INNOVATIVER SITZ MIT
INTEGRIERTEM GRIFF
INNOVATIVE SEAT DESIGN
WITH INTEGRATED HANDLE



VERSTELLBARER SITZ
ADJUSTABLE SEAT

BEWÄHRTER
TOPTRIKE GRIFF
TRIED AND TESTED
TOPTRIKE HANDLE



KATEGORISIERUNG DER FAHRZEUGE

CLASSIFICATION OF VEHICLES

Die nachfolgende Tabelle gibt Ihnen einen anschaulichen Überblick über die Fahrzeuge der verschiedenen Kategorien, ergänzt um Informationen zu Anzahl und Alter der Kinder.

The following chart presents all our categories of vehicles in a clear overview, supplemented by information on age and number of riders.

Art.Nr. item no.	Produkt Product	U3 Under 3	Kindergarten	Schule School	Fahrer No. of drivers	Seitenzahl Page
Rutschräder · Ride-on vehicles						
64100	Rutschrad „Quaddy“ · Quaddy	•			1	173
64300	Rutschrad „Little Driver“	•	•		1	170
Dreiräder ohne Pedalen · Tricycles without pedals						
64240	LaufRAD „Little Drifter“ · Little Drifter	•			1	173
Dreiräder mit Pedalen · Tricycles with pedals						
64050	Kleines Dreirad · Small Trike	•			1	174
64120	Dreirad „Rider“ · Rider			•	1	179
64130	Chopper		•	•	1	179
64290	Drift Rider		•	•	1	178
64310	Dreirad „Little Cruiser“	•	•		1	170
Dreiräder mit mehreren Sitzvarianten · Tricycles with several seating positions						
64060	Dreirad „Rookie“ · Rookie		•	•	1–2	179
64080	Dreirad „Express“ · Express Trike		•	•	1–2	188
64170	Dreirad „Seitenwagen“ · Side Car		•	•	1–2	182
64070	Dreirad „Taxi“ · Taxi		•		1–3	188
64140	Dreirad „Doppeltaxi“ · Pillion Taxi		•	•	1–3	182
64180	Rikscha · Rickshaw		•	•	1–3	189
LaufRäder · Walking Bikes						
64030	LaufRAD „Little Walker“ · Little Walker	•			1	179
64040	LaufRAD „Walker“ · Walker		•		1	189
64320	LaufRAD „Little Balancer“	•	•		1	171
Kinderspielfahrzeuge · Play Bikes						
64200	Lernfahrrad „Top Bike“ · Top Bike		•	•	1	188
64380	Quad		•	•	1	177
64270	Speed Star, Small		•	•	1	183
64280	Speed Star, Big			•	1	183
64330	Step'n Roll, Small		•	•	1	180-181
64340	Step'n Roll, Big		•	•	1	180-181
64116	Wheelie 4er Set · Set of 4 NEW		•		1	176
Roller · Scooters						
64190	Krippenroller · Mini Rolly	•			1	175
64000	Roller „Bengy“ · Scooter “Bengy”		•		1	185
64010	Roller, groß · Scooter, big			•	1	185
64020	Roller, klein · Scooter, small		•	•	1	184
64390	Roller Maxi NEW			•	1	186-187



64100

RUTSCHRAD »QUADDY«

Das Rutschrad „Quaddy“ ermöglicht schon den ganz Kleinen die erste Fortbewegung auf vier Rädern. Kinder lernen mit diesem Rutschrad, sich mit den Beinen abzudrücken um vorwärts zu kommen und gleichzeitig zu lenken. Ein sicherer Stand ist durch die vier Räder gewährleistet.

QUADDY

“Quaddy” gives the youngest children the opportunity to move on four wheels. With “Quaddy”, the children learn to push themselves of with their legs, in order to move forward and steer simultaneously. A secure footing is guaranteed by the four wheels.

Größe | Size: 530 x 320 x 350 mm

Boxgröße | Box size: 565 x 335 x 280 mm

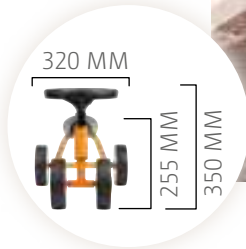

64240

LAUFRAD »LITTLE DRIFTER«

Das Laufrad „Little Drifter“ bietet mit seinen drei Rädern nicht nur sicheren Fahrkomfort, sondern auch einen sicheren Stand. Problemlos kann eine Ruhepause eingelegt werden, um sich eine neue „Rennroute“ auszugucken.

LITTLE DRIFTER

With its three wheels, “Little Drifter” not only offers a safe driving comfort, but a secure footing as well. Without any problems, you can take a break and figure out a new racing route.

Größe | Size: 800 x 410 x 500 mm

Boxgröße | Box size: 590 x 430 x 290 mm

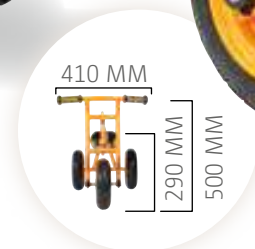



FAHRSPASS AUCH FÜR DIE KLEINSTEN! | DRIVING FUN EVEN FOR THE YOUNGEST!

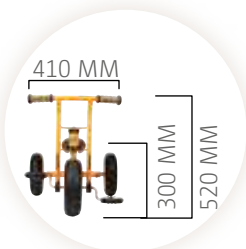

64050

KLEINES DREIRAD

Jetzt können die Kleinsten losstrampeln! Das kleine Dreirad bietet einen tollen Einstieg in das Treten von Pedalen. Kinder können mit diesem Fahrzeug die Koordination von Treten und Lenken optimieren.

SMALL TRIKE

Now, it is time for the youngest children to pedal away! The "Small Trike" provides a great introduction to pedalling. The children can improve the coordination of pedalling and steering with this vehicle.

Größe | Size: 750 × 440 × 520 mm

Boxgröße | Box size: 540 × 490 × 280 mm



64350

BUGGY

Der Buggy von beleduc ist das perfekte Gefährt für alle geliebten Puppen und Kuscheltiere und auch Kinder. Ideal für alle Mutter-Kind Rollenspiele. Durch die hohe Stabilität (bis 50 kg) können sich die Kinder gegenseitig auf dem Spielplatz und Außengelände fahren. Durch die hinteren mitlenkenden Rollen ist der Buggy unglaublich wendig und meistert auch enge Kurven. Das bringt in der Nutzung Fahrspaß für den Fahrer sowie für den Schiebenden. Bei kleinen, engen Kurven bieten die ausgestellten Griffe Halt und der Geschobene hat den Eindruck den Buggy selbst zu steuern.

The Buggy by beleduc is the best transportation for all loved dolls and cuddly toys. Ideal for mother-child-role play which children love. Due to its durability (up to 50 kg) children can also drive each other around on the playground. Our Buggy is very agile due to the rotatable backwheels and small turns are no problem. Amazing playing fun for both driver and passenger is guaranteed. In smaller, tight turns the handles on the sides offer great stability and the one being pushed feels as if they are directing the Buggy themselves.

Größe | Size: 600 × 630 × 475 mm

Boxgröße | Box size: 890 × 550 × 275 mm



AUCH IN TOPPLAY (S. 210)
ALSO IN TOPPLAY (P. 210)

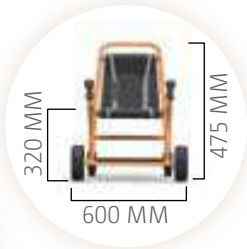

EXTREM WENDIGE HINTERRÄDER
EXTREMELY FLEXIBLE BACKWHEELS

VIELSEITIG UND WENDIG!
VERSATILE AND AGILE!



64030

LAUFRAD »LITTLE WALKER«

Das Laufrad „Little Walker“ ist ein toller Begleiter für die Kleinsten. Mit diesem Gefährt können Kinder ihren Körperschwerpunkt entdecken und lernen, das Gleichgewicht auszubalancieren.

LITTLE WALKER

Our “Little Walker” is a great companion for the youngest children. With this vehicle, the children can find their body’s centre of gravity and learn to coordinate their balance.

Größe | Size: 760 × 410 × 500 mm

Boxgröße | Box size: 555 × 420 × 280 mm

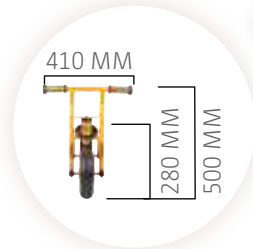

64190

KRIPPENROLLER

Mit dem Krippenroller kommen schon die Kleinsten richtig in Fahrt. Das Umfallen des Rollers wird durch zwei Räder an seinem hinteren Ende verhindert. Somit bietet er einen festen Stand für kleine Kinder, die eventuell noch nicht so gut die Balance halten können.

MINI ROLLY

With “Mini Rolly” even the youngest kids get into gear! Two wheels at the end of the roller prevent it from tipping over. Therefore, “Mini Rolly” offers a stable footing for the smallest children, who might not yet be able to keep their balance.

Größe | Size: 680 × 265 × 580 mm

Boxgröße | Box size: 560 × 175 × 420 mm

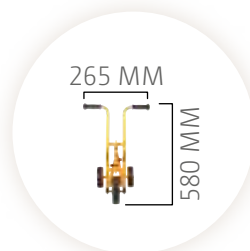



IDEAL FÜR DAS SPIEL DRINNEN UND DRAUSSEN!
IDEAL FOR INDOOR AND OUTDOOR PLAY!

SLALOM & PARCOURS | SLALOM & COURSE



4ER SET
SET OF 4

64116

WHEELIE, 4ER SET

Auf die Plätze fertig los ... Dieses Spielrad macht jede Menge Spaß und begeistert alle Kinder! Es motiviert zu viel Bewegung - egal ob drinnen oder draußen. Das Wheelie regt außerdem die Fantasie an und wird zum Rollenspiel-Highlight, wenn jedes Hindernis und die engsten Kurven im Parcours genommen werden. Es trainiert das Gleichgewicht, die Koordination und fördert die Kommunikationsfähigkeit und eignet sich ideal für die erste spielerische Verkehrserziehung.

Ready, steady, go ... This wheelie is a lot of fun and inspires all children! It motivates to a lot of movement whether indoors or outdoors. The Wheelie also stimulates the imagination and becomes a role-playing highlight when taking every obstacle and the tightest curves in the course. It trains balance, coordination and promotes communication skills and is ideal for the first traffic education.

Größe | Size: 720 x 210 x 210 mm
Boxgröße | Box size:
460 x 460 x 780 mm (4er Set | Set of 4)

NEW!



WETTRENNEN | COMPETITION



VERKEHRSERZIEHUNG | TRAFFIC EDUCATION

3+ FOB 2 kg



UNBEDINGT ANSCHAUEN!
HAVE A LOOK!



Kids Video

5 JAHRE
GARANTIE
5 YEARS
WARRANTY



720 MM

DIE KOSTENGÜNSTIGSTE UND PLATZSPARENDE
ALTERNATIVE FÜR VIEL SPASS IN DER GRUPPE
THE LOW-COST AND SPACE-
SAVING ALTERNATIVE FOR LOTS OF FUN IN THE GROUP

MOTORIK-SPIEL | MOTOR SKILLS-GAME

ALLEINE ODER IM TEAM
(WETTRENNEN, SLALOM, PARCOURS)
ALONE OR IN A TEAM
(RACE, SLALOM, PARCOURS)

INDOOR
&
OUTDOOR!



64380

QUAD – MIT ALLRAD-LENKUNG

Das neue TopTrike Quad bietet Kindern eine neue Möglichkeit der Bewegung. Es fördert die Bewegung und motiviert Kinder, sich draußen an der frischen Luft aufzuhalten. Das Besondere: Enger Wendekreis, neue Art der Fortbewegung. Das Quad, mit seinen vier XL Reifen wurde so konzipiert, dass die Kurven extrem eng gefahren werden können. Die Direktübertragung und Ergonomie macht das Fahren lernen für jedes Kind ganz einfach.

QUAD – WITH ALL-WHEEL-STEERING

The new TopTrike Quad offers children a new way to move. It promotes the sense of balance and motivates the children to move outside in the fresh air. The special feature: Tight turning circle, new way of moving around. The quad with its four XL wheels was designed that the curves can be driven extremely tightly. Direct transmission and ergonomics make learning to drive easy for every child.

Größe | Size: 680 × 1170 × 620 mm



IMMER UNTER KONTROLLE, DA LENKER UND PEDALEN UNABHÄNGIG VONEINANDER FUNKTIONIEREN
ALWAYS UNDER CONTROL BECAUSE HANDLEBARS AND PEDALS WORK INDEPENDENTLY OF EACH OTHER.



XL REIFEN
XL WHEELS



COOL DESIGN MIT 4 GROSSEN RÄDERN | COOL DESIGN WITH 4 LARGE WHEELS

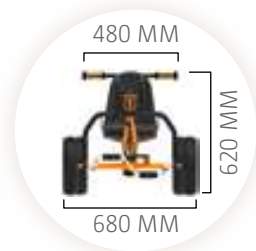

NEW!

AUF VIER RÄDERN UND MIT PEDAL-ACHSE STABIL & SICHER UNTERWEGS
ON FOUR WHEELS AND WITH PEDAL AXLE STABLE AND SAFE ON THE ROAD

FÄHRT VORWÄRTS UND RÜCKWÄRTS
MOVES FORWARDS AND BACKWARDS

WÄCHST DANK DES VERSTELLBAREN SITZES MIT
GROWS WITH THE CHILD DUE TO THE ADJUSTABLE SEAT



ALLRAD-LENKUNG – EXTREM ENG FAHRBARE KURVEN | ALL-WHEEL STEERING – CURVES CAN BE DRIVEN EXTREMELY TIGHTLY



SOWOHL VORDER- ALS AUCH HINTERACHSE LENKEN MIT
STEERING WITH BOTH FRONT AND REAR AXLE

Änderungen vorbehalten. Liefertermin Herbst 2023. | Changes reserved. Delivery date autumn 2023.





Unser beleduc-Tipp

DRIFT RIDER



64290

DRIFT RIDER

Mit seinen beweglichen Hinterrädern ermöglicht der neue Driftrider außergewöhnliche Fahreigenschaften. Wie ein Dreirad kann er zielgenau gesteuert werden. Durch Körperspannung und Gewichtsverlagerung können Kurven mittles "driften" oder das Fahrzeug auf der Stelle gewendet werden. Ein riesiger Fahrspaß ist garantiert!

The Drift Rider enables exceptional driving characteristics due to its moveable back wheels. He can be navigated precisely like a tricycle. Through body tension and shifting your weight curves can be "drifted" or the rider can be turned on the spot. Huge driving fun is guaranteed.

Größe | Size: 1200 × 520 × 670 mm
Boxgröße | Box size: 970 × 560 × 375 mm

5+

FOB

11 kg



VERSTELLBARER SITZ

ADJUSTABLE SEAT



**BEWEGLICHE HINTERRÄDER
FÜR NEUE FAHREIGENSCHAFTEN**
MOVEABLE BACK WHEELS FOR
NEW DRIVING CHARACTERISTICS

Our beleduc-tip

DRIFT RIDER



64130

CHOPPER

Entspannt cruisen! Dieses tolle Gefährt bietet ein besonderes Fahrgefühl dank seines tiefen Sitzes mit Lehne und der hohen Lenkvorrichtung.

Relaxed cruising! This great "Chopper" offers a unique riding experience with its low seat and backrest and high handles.

Größe | Size: 960 x 590 x 660 mm
Boxgröße | Box size: 760 x 530 x 360 mm



VERSTELLBARER SITZ
ADJUSTABLE SEAT



64120

DREIRAD »RIDER« | RIDER

Einzigartig für alle Terrains! Dieses Trike bietet mit seinem niedrigen Sitz und der beidseitigen Lenkvorrichtung in Höhe des Sitzes einen speziellen Fahrkomfort.

Unique for all terrains! This trike offers driving comfort with its low seat and the steering mechanism on both sides, which is the same height as the seat.

Größe | Size: 930 x 620 x 340 mm
Boxgröße | Box size: 780 x 610 x 350 mm



64060

DREIRAD »ROOKIE« | ROOKIE

Das Dreirad „Rookie“ ist der perfekte Gefährte für Kindergarten- und Vorschulkinder. Mit seinem langen und bequemen Sitz können längere Strecken problemlos geradelt werden. Eine Pause im Sitzen zum Beobachten und Entdecken ist durch die drei Räder ebenfalls möglich.

Our "Rookie" is the perfect companion for kindergarten and pre-school children. With its long and comfortable seat, larger distances can be managed easily. During a break, observing and discovering while sitting is no problem, thanks to the three wheels.

Größe | Size: 930 x 550 x 640 mm
Boxgröße | Box size: 690 x 480 x 415 mm

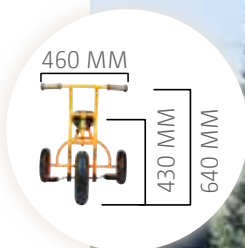



STEP'N ROLL

*Die völlig innovative, neue Antriebsart!
A novel innovative way of driving!*

TIPP!





64330

STEP'N ROLL SMALL

Mit dem STEP'N ROLL unterstützt beleduc gezielt Kinder, ihren Bewegungsdrang auszuleben. Die für ein Kinderfahrzeug völlig neuartige Antriebsart ist ein absolutes Novum. Die Trittbewegung ähnelt der eines Crosstrainers und ist selbsterklärend. Man kann mit dem Fahrzeug nicht nur vorwärts, sondern auch rückwärts sicher fahren! Das Fahrzeug fördert im hohen Maße den Gleichgewichtssinn sowie die gesamte Körperkoordination.

With the Step'n'Roll beleduc wants to motivate children to move freely. The innovative way to drive the Step'n'Roll is completely novel for children's toys and a totally unique selling point in the market. The movement is similar to training on a cross-trainer and self-explanatory once a child starts using the vehicle. With our Step'n'Roll children can safely drive forwards as well as backwards. This trike especially trains balance as well as body coordination!

Größe | Size: 530 x 870 x 740 mm

Boxgröße | Box size: 760 x 570 x 320 mm



VERBESSERTE BAUWEISE
IMPROVED CONSTRUCTION

4+

TopTrike
STEP'N ROLL SMALL

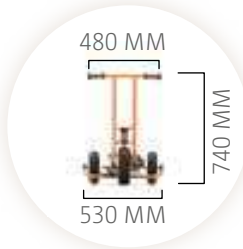

FÄHRT VORWÄRTS
UND RÜCKWÄRTS
DRIVES FORWARDS
& BACKWARDS

TRAINIERT DIE
GESAMTE KOORDINATION
TRAINS COORDINATION
HOLISTICALLY

64340

STEP'N ROLL BIG

Mit dem Step'n Roll BIG unterstützt beleduc gezielt Schulkinder, ihren Bewegungsdrang auszuleben. Die Antriebsart ist außergewöhnlich und neu. Die Trittbewegung ähnelt der eines Crosstrainers und ist selbsterklärend. Hier kann nicht nur vorwärts, sondern auch rückwärts gefahren werden. Die Schulung der Motorik und Sicherheit beim Fahren stehen hierbei im Vordergrund. Mit einer hohen Lenkstange und einer Belastbarkeit von bis zu 50 kg ist der Step'n Roll BIG perfekt für größere Kinder geeignet.

With the Step'n'Roll beleduc wants to motivate children to move freely. The innovative way to drive the Step'n'Roll is completely novel and a totally unique selling point in the market. The movement is similar to training on a cross-trainer and self-explanatory once a child starts using the vehicle. Here children can safely drive forwards as well as backwards. This trike especially trains balance as well as body coordination and safety if our main priority. Due to its high handlebar and a capacity of carrying up to 50 kg, the Step'n Roll BIG is perfect for bigger children.

Größe | Size: 530 x 870 x 820 mm

Boxgröße | Box size: 785 x 585 x 300 mm

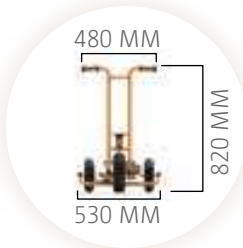

UP & DOWN



UNBEDINGT ANSCHAUEN!
I HAVE A LOOK!
Kids Video



6+

TopTrike
STEP'N ROLL BIG



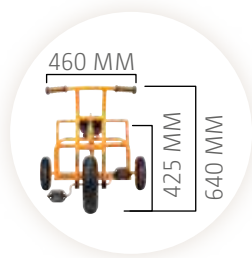

64140

DREIRAD »DOPPELTAXI«

Das Dreirad „Doppeltaxi“ bietet Platz für bis zu drei Kinder. Ein Kind kann dieses robuste Gefährt fahren und bis zu zwei Kinder können eine Fahrt, auf der Bankvorrichtung hinter dem Fahrer, genießen.

PILLION TAXI

The tricycle “Pillion Taxi” offers room for up to three children. One child can drive the sturdy vehicle and up to two kids can enjoy the ride while sitting on the back seat.

Größe | Size: 1130 × 680 × 640 mm
Boxgröße | Box size: 950 × 540 × 450 mm



64170

DREIRAD »SEITENWAGEN«

Seite an Seite die Fahrt mit dem Dreirad genießen! Das Dreirad „Seitenwagen“ eignet sich für zwei Kinder. Der Mitfahrer kann zudem die Aussicht nach vorn genießen.

SIDE CAR

Enjoying the ride side by side with the “Side Car”! The tricycle is suitable for two children. The passenger can also enjoy the view ahead.

Größe | Size: 910 × 800 × 640 mm
Boxgröße | Box size: 705 × 725 × 440 mm





SPEED STAR

Durch seine besondere Form bietet der Speed Star ein ganz neues Fahrgefühl. Durch gezielte Hin- und Her-Bewegungen der Füße, kann das Fahrzeug zielgenau gesteuert werden. Der bequeme Sitz bietet in Verbindung mit den innovativen Griffen einen sicheren Halt.

Due to its special construction the Speed Star offers a totally new driving experience. Through precise left and right movements of the feet the vehicle can be navigated accurately. The comfortable and ergonomically formed seat in combination with the innovative handles ensure your safety.



Small



760 MM

IN 2 GRÖSSEN | IN 2 SIZES

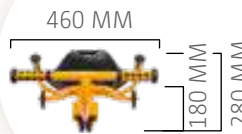

64270 · »SPEED STAR« SMALL

Größe | Size: 760 × 460 × 280 mm

Boxgröße | Box size: 750 × 460 × 280 mm

4-6

FOB

5,85 kg

GROSSER FAHRSPASS!
HUGE DRIVING PLEASURE!

FÜR GANZHEITLICHE BEWEGUNGSKOORDINATION UND KÖRPERBEHERRSCHUNG
DEVELOPS HOLISTIC COORDINATION OF MOVEMENT AND BODY CONTROL

SPEED STAR BIG

FÜR ÄLTERE UND GRÖßERE KINDER GEEIGNET
SUITABLE FOR OLDER AND BIGGER CHILDREN

DER STAR AUF ALLEN SCHULHÖFEN
THE STAR ON EVERY PLAYGROUND

TIPP!

Big



850 MM

64280 · »SPEED STAR« BIG

Größe | Size: 850 × 460 × 280 mm

Boxgröße | Box size: 880 × 315 × 520 mm

7-10 FOB 6 kg

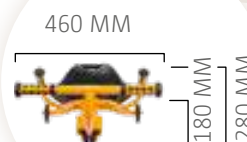



ROLLER

Für unglaubliche Fahrerlebnisse!
For amazing riding adventures!



64020

ROLLER, KLEIN

Der kleine Roller steht seinem „großen Bruder“ in nichts nach. Auch er verfügt über ein rutschfestes Trittbrett, EVA-Reifen und eine Bremse.

SCOOTER, SMALL

The small scooter is just as good as its "big brother". It is equipped with an anti slip running board, EVA tyres and a brake, as well.

Größe | Size: 1070 × 470 × 720 mm

Boxgröße | Box size: 810 × 210 × 520 mm





64000

ROLLER »BENGY«

Das breite, halbmondförmige Antirutschbrett sowie die drei Räder und eine Bremse sorgen für einen festen Stand und riesigen Fahrspaß. „Bengy“ bietet einen guten Einstieg ins Rollerfahren.

SCOOTER »BENGY«

The wide, crescent anti slip board and the three wheels and the brake provide for a secure footing and endless “driving pleasure”. “Bengy” offers a suitable introduction to riding a scooter.

Größe | Size: 760 × 410 × 500 mm

Boxgröße | Box size: 760 × 410 × 670 mm



NEUES FAHRERLEBNIS – DREIRAD ROLLER
NEW DRIVING EXPERIENCE – THREE-
WHEELED SCOOTER

SICHERER STAND
SECURE STAND

OPTIMALE GELÄNDEEIGENSCHAFTEN
OPTIMAL OFF-ROAD ABILITIES

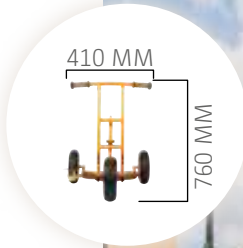

64010

ROLLER, GROSS

Der große und stabile Roller macht das Rollerfahren zu einem unglaublichen Erlebnis. Das rutschfeste Trittbrett und die EVA-Reifen sorgen für einen tollen Fahrkomfort. Durch die installierte Bremse ist ein schneller Stand garantiert.

SCOOTER, BIG

Let's go for a fantastic scooter ride! The big and solid Scooter makes scooter riding an amazing adventure. The anti slip running board and the EVA tyres ensure a great ride comfort. The installed brake guarantees a quick stop.

Größe | Size: 1070 × 480 × 820 mm

Boxgröße | Box size: 790 × 190 × 510 mm

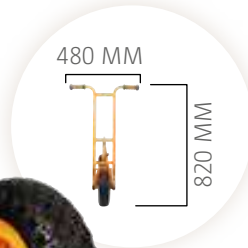



ROLLER “MAXI” XL

*Der Klassiker für die Großen!
The classic for the grown-ups!*

NEW!

SCOOTER



Kids Video

UNBEDINGT ANSCHAUEN!
HAVE A LOOK!



FIT FOR SCHOOL



64390

ROLLER »MAXI«

Mit dem neuen TopTrike Maxi Roller ist Fahrspaß auch für größere Kinder garantiert. In neuem Design in anthrazit und orange mit Nummernschild! Der Roller ist in bekannter TopTrike Qualität besonders gut geeignet für den Pausenhof und sorgt für jede Menge Spaß und Bewegung.

SCOOTER »MAXI«

With the new TopTrike Maxi Scooter, driving fun is also guaranteed for older children. In a new design in anthracite and orange with number plate. The scooter in well-known TopTrike quality is especially suitable for the playground and provides lots of fun and movement.

Größe | Size: 1200 × 480 × 905 mm

Boxgröße | Box size: 880 × 240 × 500 mm



NEUES UND INNOVATIVES DESIGN | NEW AND INNOVATIVE DESIGN



ROBUSTE HANDGRIFFE MIT GUMMINOPPEN FÜR SOLIDEN HALT
SOLID HANDLE WITH RUBBER NUBS FOR A GOOD GRIP

DAS HIGHLIGHT FÜR JEDEN PAUSENHOF!
THE HIGHLIGHT FOR EVERY PLAYGROUND!

COOLES DESIGN
COOL DESIGN

XL RAHMEN & EXTRA GROSSE REIFEN
XL FRAME & EXTRA LARGE TYRES



STARKER METALLRAHMEN MIT 22 MM DURCHMESSER
HEAVY STEEL FRAMES WITH A DIAMETER OF 22 MM

DURCHGESCHÄUMTE EVA-REIFEN FÜR LANGE LEBENSDAUER UND LEISES FAHREN
EVA-FOAMED TYRES FOR LONG LIFE DURABILITY AND QUIET CRUISING

FUSSBREMSE
BRAKE

NUMMERNESCHILD
NUMBER PLATE

RIFFEL-METALLBLECH
RIPPED SHEET METAL

XL REIFEN
XL TYRES

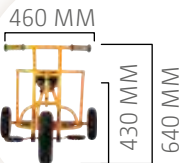

64080

DREIRAD »EXPRESS«

Das Dreirad bietet Fahrspaß für zwei Kinder. Ein Antirutschbrett und eine Brüstung sorgen für einen sicheren Stand des Mitfahrers.

EXPRESS TRIKE

It provides much "driving pleasure" for two children. An anti slip board and a railing give the passenger a secure footing. This vehicle offers various role playing possibilities.

Größe | Size: 1180 x 650 x 640 mm

Boxgröße | Box size: 930 x 520 x 450 mm



64070

DREIRAD »TAXI« | TAXI

Mit dem Dreirad „Taxi“ lassen sich Freunde ganz bequem chauffieren. Zwei Sitze sind hintereinander angebracht und ein Antirutschbrett gibt einem dritten Passagier einen sicheren Stand. Eine Rückenlehne an den beiden Sitzen sorgt für besonderen Komfort.

With our "Taxi", best friends can be given a comfortable ride. Two seats are mounted in a row and an anti slip board gives a secure footing for a third passenger. A back on both seats provides for a special comfort.

Größe | Size: 1120 x 560 x 640 mm

Boxgröße | Box size: 940 x 540 x 480 mm



64200

LERNFAHRRAD »TOP BIKE«

Erstes Fahren auf zwei Rädern! Das Lernfahrrad „Top Bike“ ist ideal, um das Balancehalten und Lenken zu trainieren. Es dient als Übergangsrads von Dreirad auf Fahrrad.

TOP BIKE

First ride on two wheels! The learning bike "Top Bike" is ideal to train balance and steering. It serves as transition vehicle from tricycle to bicycle!

Größe | Size: 930 x 460 x 640 mm

Boxgröße | Box size: 675 x 487 x 365 mm

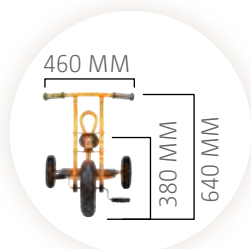



64180

RIKSCHA

Lauf- und Fahrvergnügen mit der Rikscha! Mit der zweirädrigen Rikscha kann ein Kind von einem zweiten Kind gezogen werden. Hierbei verhindern EVA-Griffe das Abrutschen der Hände von der Stange. Ein kleines Stützrad am hinteren Ende sorgt für zusätzliche Stabilität.

RICKSHAW

Running and driving pleasure with our Rickshaw! With the two-wheeled rickshaw one child can be pulled by another. The EVA handles prevent hands from slipping off. A small wheel at the rear of the rickshaw offers additional stability.

Größe | Size: 1220 × 650 × 500 mm

Boxgröße | Box size: 735 × 510 × 520 mm

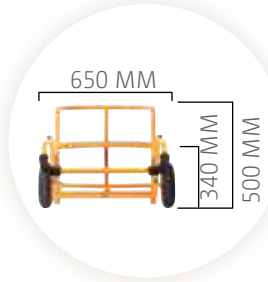

ABGERUNDETE REIFEN FÜR
BESTE BALANCE-EIGENSCHAFTEN
ROUNDED TYRES TO ENSURE BEST BALANCE

VERSTÄRKTE GRIFFKAPPEN – ROBUST
WENN DAS LAUFRAD HINFÄLLT
REINFORCED HANDLE COVERS – ROBUST
WHEN THE TRAINING BIKE FALLS OVER

LANGE SITZBANK – SOMIT OPTIMALE
NUTZUNG FÜR UNTERSCHIEDLICHE KINDER
LONG SEAT – ENSURES OPTIMAL USAGE
FOR CHILDREN OF DIFFERENT SIZES



64040

LAUFRAD »WALKER«

Mit dem Laufrad „Walker“ sind Kinder dazu angehalten, die Balance zu halten und auszugleichen. Es bereitet zudem gut auf das spätere Fahrradfahren vor.

WALKER

With our „Walker“, children learn to find and keep their balance. In addition, it offers a great preparation for riding a bicycle later.

Größe | Size: 890 × 460 × 620 mm

Boxgröße | Box size: 625 × 225 × 490 mm

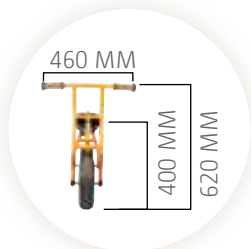



62060

MOBILE TANK- & SERVICESTATION

Die TopPlay „Tank- und Servicestation“ ist die perfekte Ergänzung zu allen TopTrike Fahrzeugen. Spielerisch können Kinder ihre Fahrzeuge tanken und Rollenspiele entwickeln. Tolle Details, wie 2 Tankpistolen, Drehscheiben für Preise oder zum Einstellen der Rundenanzahl bei Auto-Rennen sind inklusive. Ebenso viel Platz für Eimer, Schwamm und Ölkanne ... alles was zu einer Tank- und Servicestation dazugehört. Die beschreibbaren Kreidetafeln machen dieses innovative Produkt zum Highlight.

MOBILE GAS & SERVICE STATION

The TopPlay „Mobile Gas and Service Station“ is the perfect addition to all TopTrike vehicles. Children can playfully refuel their vehicles and develop role-playing games. Great details such as 2 fuel guns, dials for prizes or for setting the number of rounds in the car race are included. Also plenty of space for buckets, sponges and oil cans ... everything you need for a gas and service station. The writeable chalkboards make this innovative product a highlight.

AUCH IN
TOPPLAY
(S. 198/199)

ALSO IN
TOPPLAY
(P. 198/199)

DIE IDEALE ERGÄNZUNG
ZU ALLEN TOPTRIKE
FAHRZEUGEN

IDEAL ADDITION
FOR ALL TOPTRIKE
VEHICLES



DREHSCHIEBEN
FÜR PREISE ODER
RUNDENANZAHL BEI
AUTO-RENNEN
DIALS FOR PRIZES OR
NUMBER OF ROUNDS
IN A CAR RACE

4+

FOB

10,4 kg

NEW!

DIE TANKSTATION VERFÜGT ÜBER RÄDER UND IST FAHRBAR | THE GAS STATION HAS WHEELS AND IS MOBILE



KANN VON BEIDEN
SEITEN BESPILT WERDEN
CAN BE PLAYED WITH
FROM BOTH SIDES

Änderungen vorbehalten. Ohne Dekoration. | Changes reserved. Without decoration.

ZUBEHÖR/EQUIPMENT



60200

ROLLERSTAND | SCOOTER STAND

Bis zu vier Roller oder Trikes können in den Rollerstand gestellt werden. Da sich dieser Stand mit Schrauben im Boden verankern lässt, ist eine gute Stabilität garantiert.

Up to four scooters or trikes can be placed in the Scooter Stand. Since this stand can be fixed to the ground with screws, stability is guaranteed.

Größe | Size: 1200 × 210 × 130 mm



60201

WANDHÄNGER | SCOOTER HANGER

Mithilfe des Wandhängers können Trikes und Roller platzsparend an der Wand aufbewahrt werden.

With the Scooter Hanger trikes and scooters can be hung on the wall and be stowed in a space-saving manner.

Größe | Size: 180 × 230 × 230 mm

BELASTBAR MIT 20 KG
LOAD CAPACITY 20 KG

FOB



68170

FAHRSPUREN, 3ER SET SET OF 3 ROAD DIRECTIONS

Mit dem Fahrspurenset kann ein toller Straßenparcours gestaltet und auch erste Verhaltensregeln im Straßenverkehr mit den Kindern geübt werden.

With the set of 3 road directions you can create a great street course, but also teach children the first rules of conduct on the road.

Größe je | Size each: 580 × 900 mm

FOB

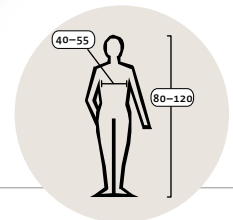

68190

WARNWESTE | WARNING VEST

Die Warnweste mit Leuchtapplikatoren macht die jungen Fahrer für jedermann gut sichtbar. Da sie an den Seiten über einen Gummizug verfügt, ermöglicht sie eine gute Passform für verschiedene Altersgruppen.

With the warning vest with reflective strips young drivers become more visible. Thanks to its elastic bands on the sides, it is adaptable to different age groups.

Größe | Size: 450 × 540 mm

3+ FOB

3-6 FOB !1



NATUR & KINDER

NATURE & CHILDREN



Wir bei beleduc setzen uns leidenschaftlich dafür ein, die Interaktion und Verbindung zwischen Kindern und der Natur zu fördern, damit Kinder lernen und sich entwickeln können. Wir glauben, dass Kinder, die täglich mit der Natur in Kontakt sind, die perfekten Botschafter für den Schutz und die Förderung von Initiativen für die Umwelt und klimafreundliches Verhalten sind.

Bei beleduc sind wir auch neugierig darauf, was die Forschung uns sagt, insbesondere die nordische Forschung bestätigt, dass Kinder, die Zeit in der Natur verbringen und in der Natur spielen und experimentieren dürfen, bessere motorische Fähigkeiten, eine bessere Aufmerksamkeit und eine bessere Problemlösung entwickeln und gesünder sind als Kinder, die nicht viel Zeit in der Natur verbringen.

Wir möchten mit Spiel- und Lernumgebungen dazu beitragen, die ganzheitliche Entwicklung des Kindes zu fördern.

Mit unserer TopPlay-Produktreihe bieten wir nun das gleiche hohe Maß an Spiel-, Erfahrungs- und Lernwert, aber jetzt in einem Format, das zu einer

qualitativen Spiel- und Lernumgebung im Freien beiträgt. **Wir sind uns bewusst, dass das Spielen, Erleben und Lernen von Kindern gute Bedingungen erreicht, wenn wir alltägliche Aktivitäten nach draußen verlagern und sie auf eine neue und spannende Weise nutzen.**

Um diese wichtige Vision der Naturerziehung zu verfolgen, haben wir eine Zusammenarbeit mit dem dänischen, für Nachhaltigkeit ausgezeichneten Naturkindergartenexperten Michael Hall Larsen begonnen. „In der Natur lernen wir mit unserem ganzen Körper, mit unseren Händen, Augen, Ohren, unserem Gehirn und unserem Herzen. Die Natur ist ein Ort, an dem Kinder Dinge anfassen, fühlen und praktisch ausprobieren können.“ (Michael Hall Larsen)

At beleduc we are passionate about encouraging interaction and connection between children and nature that enable children to learn and develop themselves. We believe that children who are in a qualitative interaction with nature on a daily basis, become the perfect ambassador to protect and promote initiatives for the environment and climate-friendly behavior.

At beleduc, we are also curious about what the research tells us, especially the Nordic research confirms that children who spend time in nature and are allowed to play and experiment in nature, develop better motor skills, better attention, better problem solving and are healthier than children who do not spend much time out in nature.



» KINDER
BRAUCHEN DIE
NATUR UND DIE
NATUR BRAUCHT
DIE KINDER «

» CHILDREN
NEED NATURE
AND NATURE
NEEDS
CHILDREN «

We want to contribute with play and learning environments which support the child's holistic development.

With our TopPlay range of products, we now offer the same high degree of play, experience, and learning, but now in a format that contributes to a qualitative outdoor play and learning environment.

We are fully aware that children's play, experiences, and learning achieves good conditions when we move everyday activities outdoors and use them in a new and exciting way.

As an initiative to pursue this important nature education vision, we have established a collaboration with a Danish sustainability award-winning nature kindergarten expert - Michael Hall Larsen.

“In nature, we learn with our whole body, with our hands, eyes, ears, brain and heart. Nature is a place where children can touch, feel and try things out in practice.” (Michael Hall Larsen)





FIND MORE ABOUT TOPPLAY S.195 | P.195

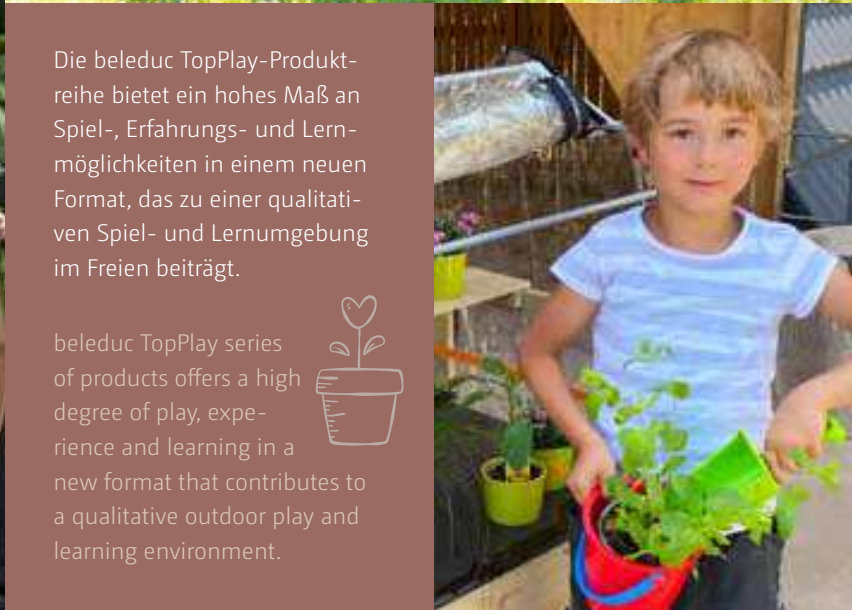

Die beleduc TopPlay-Produktreihe bietet ein hohes Maß an Spiel-, Erfahrungs- und Lernmöglichkeiten in einem neuen Format, das zu einer qualitativen Spiel- und Lernumgebung im Freien beiträgt.

beleduc TopPlay series of products offers a high degree of play, experience and learning in a new format that contributes to a qualitative outdoor play and learning environment.



In der Natur sammeln Kinder Erfahrungen durch ihre Interaktion, ihre Erlebnisse, ihr Staunen, ihre Neugierde. Die Natur ist die perfekte Lernumgebung, und aus pädagogischer Sicht bietet die Natur viele Möglichkeiten, die das natürliche Staunen des Kindes, seine sensorische Verarbeitung sowie seine kognitive und motorische Entwicklung anregen. Die pädagogische Lernumgebung muss auch dazu beitragen, dass alle Kinder sinnvolle Erfahrungen mit der Natur machen, die ihren Wunsch, die Natur zu erforschen, entwickeln und die Möglichkeit haben, eine Verbindung zur Natur zu erleben, die den Kindern ein beginnendes Verständnis für die Bedeutung einer nachhaltigen Entwicklung vermittelt.



Michael Hall Larsen, Naturkindergartenexperte | nature kindergarten expert

In nature children gain experience through their interaction, their experiences, their wonder, their curiosity. Nature is the perfect learning environment and in a pedagogical perspective, nature offers many opportunities that arouse the child's natural wonder, sensory processing, cognitive and motor development. The pedagogical learning environment must also ensure that all children get a meaningful experience with nature. Thereby they develop their desire to explore nature and get the opportunity to experience a connection with nature, which conveys them a basic understanding how important is the sustainable development.



TOPPLAY

Kreatives Rollenspiel im Freien – hier ist Spielspaß garantiert!
Creative outdoor role play – fun is guaranteed here!





**HIGHLIGHT
2023**



TOPPLAY
beleduc

TopPlay „Camping Car“ | Diese Neuheit
finden Sie auf Seite 198/199
TopPlay „Camping Car“ | You can find
this novelty on page 198/199



KIOSK 4 IN 1

*Mit dem Rollenspiel raus in die Natur!
Out into nature with role play!*

VON 4 SEITEN BESPIELBAR
PLAYABLE FROM 4 SIDES





62040

KIOSK 4 IN 1

Raus in die Natur! Mit dem beleduc Kiosk können die Rollenspiele jetzt nach draußen verlegt werden! Mehrere Kinder können dort gleichzeitig spielen, da das Kiosk genug Platz bietet. Hier sind viele Spiel-Möglichkeiten geboten, wie zum Beispiel ein Verkaufsstand/Markt, Kiosk, Eisdiel oder Imbiss/Schnellrestaurant. Das Spielen fördert das imitative und imaginäre Spiel, das Erzählen von Fantasy-Geschichten, das Rollenspiel und die Kreativität und es macht jede Menge Spaß. Ein Highlight für jede Einrichtung.

Out into nature! With the TopTrike Kiosk, role play can now be moved outside. Several children can play there at the same time because the kiosk offers enough space. There are many play options here, such as a food stand/market, kiosk, ice cream stand or snack bar/restaurant. Playing encourages imitative and imaginary play, fantasy storytelling, role play and creativity and it's a lot of fun. A highlight for any kindergarten.

Größe | Size: 1130 × 1130 × 1950 mm

Boxgröße 1 | Box size 1:
(2×) 1170 × 570 × 150 mm

Boxgröße 2 | Box size 2:
(1×) 630 × 210 × 425 mm

VIELZÄHLIGE
SPIELMÖGLICHKEITEN
NUMEROUS PLAYING
POSSIBILITIES



HIGHLIGHT



TOLLE TEXTIL-DETAILS
(WETTERFEST): WIMPELKETTE,
KIOSK-DACH & ROLLADEN
GREAT TEXTILE DETAILS
(WEATHERPROOF): BANNER
CHAIN, KIOSK ROOF
& ROLLING SHUTTER

2 KOCHPLATTEN (ROBUSTE
SIEBDRUCKPLATTE/
WETTERFEST)
2 COOKING PLATES
(ROBUST SCREEN PLATE/
WEATHERPROOF)

AUS KIEFERNHOLZ
KESELDRUCK-IMPRÄGNIERT
MADE OF PINE WOOD
PRESSURE IMPREGNATED

3 BESCHREIBBARE
KREIDETAFLN
3 WRITABLE
CHALKBOARDS

3+ 1+ **FOB**



1 OBST-/GEMÜSEKISTE
(AUS HOLZ)
1 FRUIT & VEGETABLE BOX
(MADE OF WOOD)



Kids Video

UNBEDINGT ANSCHAUEN! / I HAVE A LOOK!



Änderungen vorbehalten. Ohne Dekoration. Bitte beachten Sie unsere Pflegehinweise.
Changes reserved. Without decoration. Please note our instructions for maintenance



CAMPING CAR

Camping liegt voll im Trend!

Camping is trend!

NEW!

MIT KOCHSTATION,
LENKRAD UND BANK
WITH COOKING STATION,
STEERING WHEEL AND BENCH



PLATZSPAREND | EASY TO STORAGE



TOLLE DETAILS
GREAT DETAILS



UNBEDINGT ANSCHAUEN!
HAVE A LOOK!



Kids Video

Änderungen vorbehalten. Ohne Dekoration. Bitte beachten Sie unsere Pflegehinweise.
Changes reserved. Without decoration. Please note our instructions for maintenance



62050

CAMPING CAR

Das TopPlay Camping Car bietet Kindern eine Möglichkeit für Rollenspiele in der Natur. Hier können viele Kinder spielen. Das Camping Car kann beliebig ausgestattet werden. Der zweiteilige Aufbau mit dem Fahrerhaus ist detailreich umgesetzt, inkl. Bremse und Gas-/Bremspedal. Im hinteren Bereich erwartet die Kinder eine kleine Küche mit 2 Kochplatten und Waschbecken. Inklusive Holzbank.

The TopPlay Camping Car offers children an opportunity for role play in nature. Several children can play there at the same time. The camping car can be equipped as desired. The two-part body with the driver's cab is rich in detail, including brake and accelerator/brake pedal. A small kitchen with 2 cooking plates and a washbasin awaits the children in the back area. Wooden bench inclusive.

Größe | Size: 2350 × 630 × 1050 mm
 Boxgröße 1 | Box size 1: 940 × 500 × 230 mm
 Boxgröße 2 | Box size 2: 1120 × 710 × 180 mm
 Boxgröße 2 | Box size 2: 1120 × 650 × 180 mm



**VIELZÄHLIGE
SPIELMÖGLICHKEITEN**
**NUMEROUS PLAYING
POSSIBILITIES**

FÄHRERHAUS MIT
TOPTRIKE-LENKRAD
UND BEWEGLICHEM
SCHALTHEBEL | DRIVER'S
CABIN WITH TOPTRIKE
HORN, STEERING WHEEL
AND MOVABLE GEAR
SHIFT KNOB



ABNEHMBARE
WIMPELKETTE
DETACHABLE
PENNANT CHAIN



IDEAL FÜR DIE
GANZE GRUPPE
IDEAL FOR THE
WHOLE GROUP

XL CAMPING CAR, VON ALLEN SEITEN BESPIELBAR
XL CAMPING CAR, PLAYABLE FROM ALL SIDES

TOLLE TEXTILDETAILS UND 2 KOCHPLATTEN
GREAT TEXTILE DETAILS AND 2 COOKING PLATES

IDEAL PASSEN HIERZU: MULTIBÄNKE + XL KÜCHENSET
THE IDEAL MATCH: MULTI-BENCHES + XL KITCHEN SET

MIT 2 KOCHPLATTEN UND WASHBECKEN | WITH 2 COOKING PLATES AND A WASHBASIN



INKLUSIVE
INCLUSIVE

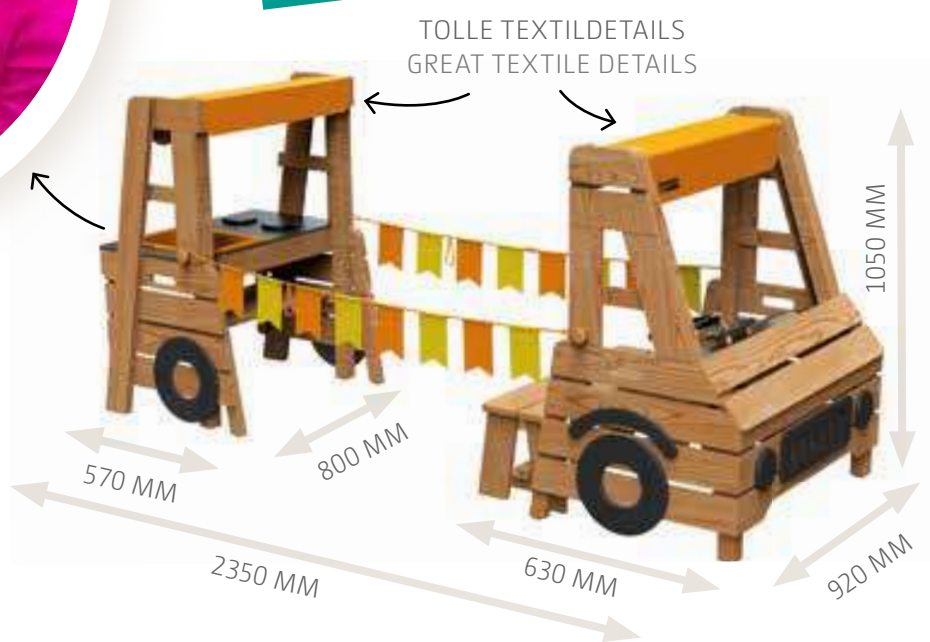

TOLLE TEXTILDETAILS
GREAT TEXTILE DETAILS



MOBILE TANK- & SERVICESTATION

„Ideal für alle TopTrike Fahrzeuge!“ | „Ideal for all TopTrike vehicles!“



MOBILE GAS & SERVICE STATION

Änderungen vorbehalten. Ohne Dekoration. | Changes reserved. Without decoration.



62060

MUST HAVE!

MOBILE TANK- & SERVICESTATION

Die TopPlay „Tank- und Servicestation“ ist die perfekte Ergänzung zu allen TopTrike Fahrzeugen. Spielerisch können Kinder ihre Fahrzeuge tanken und Rollenspiele entwickeln. Tolle Details, wie 2 Tankpistolen, Drehscheiben für Preise oder zum Einstellen der Rundenanzahl bei Auto-Rennen sind inklusive. Ebenso viel Platz für Eimer, Schwamm und Ölkanne ... alles was zu einer Tank- und Servicestation dazugehört. Die beschreibbaren Kreidetafeln machen dieses innovative Produkt zum Highlight.

MOBILE GAS & SERVICE STATION

The TopPlay „Mobile Gas and Service Station“ is the perfect addition to all TopTrike vehicles. Children can playfully refuel their vehicles and develop role-playing games. Great details such as 2 fuel guns, dials for prizes or for setting the number of rounds in the car race are included. Also plenty of space for buckets, sponges and oil cans ... everything you need for a gas and service station. The writeable chalkboards make this innovative product a highlight.

Größe | Size: 810 × 670 × 640 mm

Boxgröße | Box size: 820 × 750 × 240 mm



MIT SYMBOL FÜR EINE E-LADESTATION
WITH SYMBOL FOR E-CHARGING STATION



DREHSCHIEBEN FÜR PREISE ODER RUNDENANZAHL BEI AUTO-RENNEN
DIALS FOR PRIZES OR NUMBER OF ROUNDS IN A CAR RACE

DIE TANKSTATION VERFÜGT ÜBER RÄDER UND IST FAHRBAR | THE GAS STATION HAS WHEELS AND IS MOBILE



KANN VON BEIDEN SEITEN BESPILT WERDEN
CAN BE PLAYED WITH FROM BOTH SIDES



UNBEDINGT ANSCHAUEN!
I HAVE A LOOK!



Kids Video





XL KÜCHEN-SET



12 TLG. | PCS.

24234

XL KÜCHEN-SET

Die perfekte Ergänzung für alle TopPlay Produkte der beleduc Linie: Kiosk, Küche und Matsch-Tisch uvm. Schönes Kochset aus robustem Edelstahl. Detailgetreues Design für mehr Spielfreude. Bestehend aus: Töpfen, Pfannen, Schüsseln, Sieb, weiteren Küchen-Utensilien, wie Löffel und Co. Kinder-Kochset, 12 tlg.

XL KITCHEN SET

The perfect addition for all TopPlay products of the beleduc line: Kiosk, kitchen and mud table, etc.. Beautiful cooking set made of robust stainless steel. True-to-detail-design for more play fun. Consisting of: pots, pans, bowls, sieve and other kitchen utensils, such as spoon and co. Children's cooking set, 12 pcs.

Boxgröße | Box size: 345 × 240 × 118 mm



12 TEILE – AUS ROBUSTEM
EDELSTAHL
12 PARTS – MADE OF ROBUST
STAINLESS STEEL
SEHR GUTE UND DETAILREICHE
VERARBEITUNG
VERY GOOD AND DETAILED
WORKMANSHIP



BESONDERS HOCHWERTIGE
VERARBEITUNG DURCH EXTREM
STABILE VERNIETUNG UND
ABGERUNDETE KANTEN
PARTICULARLY HIGH-QUALITY
WORKMANSHIP DUE TO EXTREMELY
STABLE RIVETING AND ROUNDED
EDGES

**INDOOR
&
OUTDOOR!**



**12ER SET
SET OF 12**

220 MM



MOBILE MATSCHKÜCHE

INDOOR & OUTDOOR!

„Großer Chefkoch“ | „Big Chef“

BEST SELLER

XXL

spiel gut®

vom arbeitsausschuß
kinderspiel + spielzeug
ausgezeichnet
recommended



BEIDSEITIG BESPIELBAR –
EXTRA TIEFE ARBEITSFLÄCHE!
EXTRA LARGE WORKTOP –
ACCESSIBLE FROM BOTH SIDES!

MOBILE KITCHEN “BIG CHEF”



62030

MOBILE KÜCHE

Mit der Küche für den Außenbereich werden Kinder stundenlangen Spielspaß haben und im kreativen Rollenspiel zu Sternköchen werden. Hier können die köstlichsten Gerichte entstehen. Auf den 4 Ofenplatten kann fleißig gekocht werden und im Ofen werden leckere Kuchen oder Brote gebacken. Die solide Holzküche ist aus hochwertigem, wetterfestem Massivholz produziert und mit einer robusten Konstruktion versehen, sodass sie auch sicher steht. Das robuste und schlichte Design der Küche passt in jeden Kindergarten. Dank der großen und besonders breiten Arbeitsfläche können mehrere Kinder gleichzeitig auf beiden Seiten zusammen in der Gruppe spielen, Gerichte vorbereiten, kochen und abwaschen.

MOBILE KITCHEN

The outdoor kitchen will provide hours of fun role-play activities for the children and turn them into gourmet chefs. They can cook on the four stove plates and bake in the oven. The solid kitchen is made from high-quality and weather-resistant wood. It stands secure due to the robust construction. The kitchen's natural and modern design fits in every kindergarten. The large work-spaces are perfect for group play and the kitchen is accessible from all sides. All surfaces of the kitchen can be wiped down and are easy to clean. It can be easily wheeled to different places indoors or outdoors.

Größe | Size: 1060 x 600 x 1080 mm

Boxgröße | Box size: 1090 x 630 x 220 mm



SEHR ROBUSTE
SIEBDRUCKPLATTEN
VERY ROBUST SCREEN-
PRINTING PLATES

DREHBARE SCHALTER | ROTATABLE SWITCHES



Sehr robust und
wetter-resistent!

Very robust and
weather-
resistant!



KANN VON ALLEN SEITEN BESPIELT
WERDEN – PERFEKT FÜR GRUPPEN
CAN BE PLAYED FROM ALL SIDES –
PERFECT FOR GROUP PLAY

KANN LEICHT VON EINEM PLATZ
ZUM ANDEREN GEROLLT WERDEN
CAN BE EASILY WHEELED TO
DIFFERENT PLACES

DAS GANZE JAHR
ÜBER BESPIELBAR

CAN BE USED
ALL THROUGH
THE YEAR

VIELE MÖGLICHKEITEN ZUM PLATZIEREN VON ACCESSOIRES | MANY DIFFERENT POSSIBILITIES OF STORING ACCESSORIES



Bitte beachten
Sie unsere
Pflegehinweise

Please note our
instructions for
maintenance

HOCHWERTIGE REIFEN | HIGH-QUALITY TIRES



Ohne Dekoration | Without decoration





MOBILER WASSER-TISCH

„Plansch-Spaß“ | „Splash-Fun“

INDOOR
&
OUTDOOR!

FLEXIBLE SCHLÄUCHE KÖNNEN IN DAS
METALLGITTER EINGEWEBT WERDEN
FLEXIBLE SYNTHETIC TUBES CAN BE WEAVED
INTO THE METAL GRID.

INKLUSIVE FUNKTIONSFÄHIGER PUMPE
INCLUDING FUNCTIONAL PUMP

MOBILE WATER-TABLE



62020

MOBILER WASSER-TISCH

Der Wasser-Tisch bietet jede Menge Spielspaß für kreative Rollenspiele im Außenbereich. Wie reagiert Wasser und in welche Richtung läuft es, wenn ich seinen Lauf ändere? Fragestellungen, die Kinder hier testen können. Die verschiedenen Ebenen trainieren das räumliche Bewusstsein und Verständnis. Das Wasser kann mit Hilfe der Pumpe in den oberen Behälter gepumpt werden und über den Auslauf wieder in die untere Wanne fließen. Der Wasser-Tisch ist leicht zu bewegen, da er mit den Rädern schnell und einfach überall dort hingefahren werden kann, wo das Spiel stattfinden soll. Mitgeliefertes Zubehör: 2 Schläuche, 2 Trichter, 2 blaue Wippen, 3 Wassertiere mit Funktion.

MOBILE WATER-TABLE

The beleduc water table offers many possibilities for outdoor roleplay and a first contact with science. Children love to play and experiment with water and observe how it behaves in different situations. They can for example find out how water changes directions when they redirect its flow. The children can interact easily due to the transparent design which offers a great possibility for group roleplay. The water table can be easily moved to different places due to its practical wheels. Included accessories: 2 tubes, 2 funnels, 2 blue seesaws, 3 water animals with function.

Größe | Size: 1160 × 575 × 1000 mm

Boxgröße 1 | Box size 1: 970 × 170 × 760 mm

Boxgröße 2 | Box size 2: 570 × 260 × 440 mm



KANN MIT EINEM FAHRRAD-SCHLOSS GESICHERT WERDEN
CAN BE SECURED WITH A BIKE LOCK

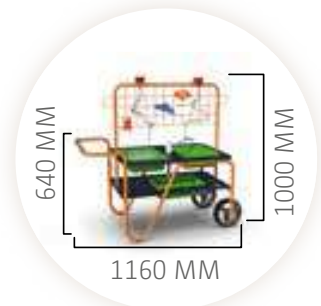

Änderungen vorbehalten (Pumpe).
Changes reserved (pump).

MIT FUNKTIONSFÄHIGER PUMPE | WITH FUNCTIONING PUMP



WASSERTIERE KÖNNEN
MIT EINEM CLIP AM GITTER
PLATZIERT WERDEN
WATERANIMALS CAN BE PLACED
ON THE GRID WITH A CLIP

OBERES UND UNTERES
WASSERBECKEN
UPPER AND LOWER
WATER BASIN

SEHR WETTER- UND WASSER-
FESTE OBERFLÄCHEN
VERY WEATHER-RESISTANT

KANN LEICHT VON EINEM PLATZ
ZUM ANDEREN GEROLLT WERDEN
CAN BE EASILY WHEELED TO
DIFFERENT PLACES

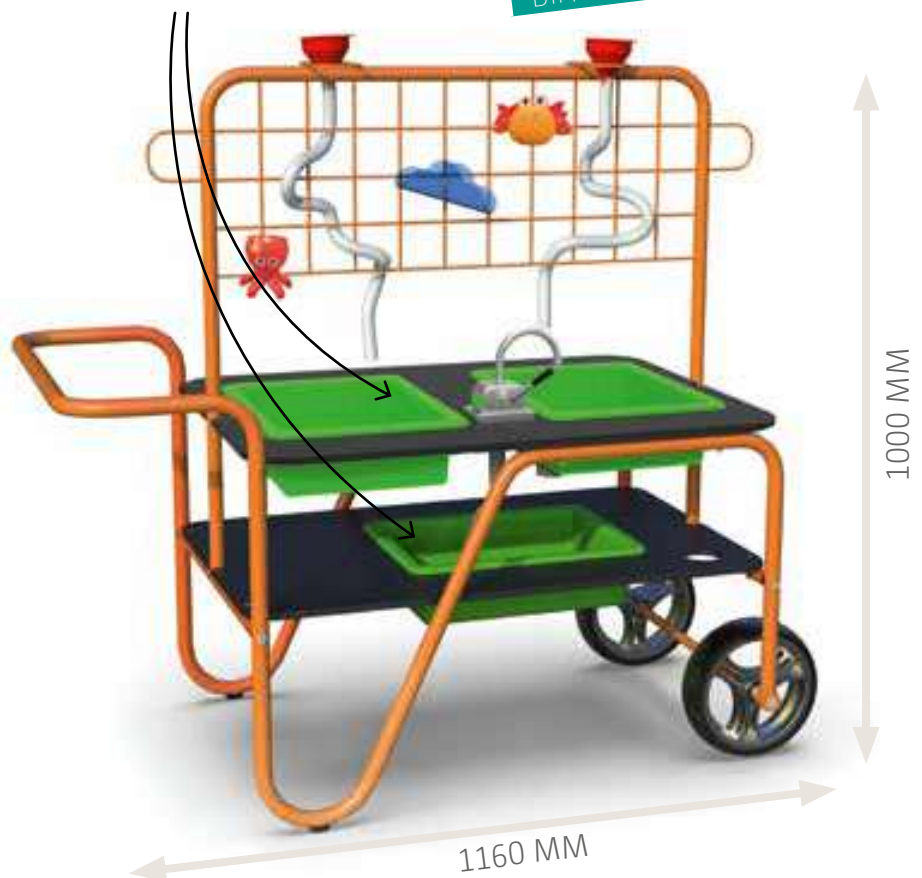

MIT WASSERKREISLAUF VOM OBEREN ZUM UNTEREN
WASSERBECKEN MIT FUNKTIONSFÄHIGER PUMPE
WITH WATER CYCLE FROM UPPER TO LOWER
INCLUDING FUNCTIONAL PUMP





**INDOOR
&
OUTDOOR!**

MOBILES GEWÄCHSHAUS

„Kleiner Gärtner“ | „Little Gardener“

**PERFEKT FÜR DIE GANZE GRUPPE
PERFECT FOR A GROUP**
**MIT TOLLEM ZUSATZMATERIAL
ONLINE ZUM DOWNLOAD!
WITH GREAT ADDITIONAL
MATERIAL FOR DOWNLOAD
WWW.BELEDUC.DE**



GARDENING-IDEAS

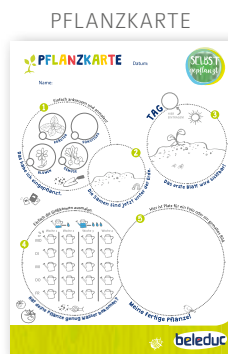

PLANTING-CARD



SAWING CALENDAR

MIT KLETT- UND REISSVERSCHLUSS
ZU ÖFFNEN UND SCHLIESSEN
CAN BE OPENED AND CLOSED WITH
VELCRO FASTENING AND ZIPPER



BIS ZU 28 BLUMEN-
TÖPFE Ø 13 CM
UP TO 28 FLOWER
POTS Ø 13 CM

Nicht enthalten |
Not included

600 MM

600 MM

1090 MM

1150 MM

MOBILE GREENHOUSE “LITTLE GARDENER”



DAS GANZE JAHR
ÜBER BESPIELBAR

CAN BE USED ALL
THROUGH THE YEAR



62010

MOBILES GEWÄCHSHAUS

Mit dem Gewächshaus entdecken Kinder die botanische Welt und können selbst zum Gärtner werden und über das ganze Jahr eigene Pflanzen, Kräuter, Gemüse und Blumen heranziehen. Nach dem Motto: Zurück zur Natur, wie entwickeln sich Pflanzen. Für Kinder ist es spannend, faszinierend und unheimlich lehrreich, wenn aus Samenkörnern etwas wächst. Ein großartiges Instrument, um Kinder zu nachhaltigem und ökologischem Denken zu erziehen. Kinder lernen alles über die Aufzucht der Pflanze vom Samenkorn an, indem man die Bedingungen schafft, welche die Pflanze braucht, um zu sprießen. Das mobile Gewächshaus kann in die Sonne oder in den Schatten gerollt werden, je nach Wetterlage. Mit aufklappbarer, transparenter Oberseite, die mit einem Reißverschluss leicht geöffnet und geschlossen werden kann.

MOBILE GREENHOUSE

The greenhouse enables children to discover the botanical world by becoming gardeners themselves. They can plant flowers, spices, vegetables and other things. It is exciting and educative for children to see something grow from a seed. The children learn to take on responsibility and consider the needs of others when caring of the plants. The greenhouse is also the ideal tool to educate children on ecological and eco-sustainable thinking and behaviour. It can be easily wheeled to different places indoors or outdoors due to its practical wheels depending on the weather and season. The transparent top, which can be opened and closed easily with a zipper, makes the greenhouse easily accessible and adaptable to all weather conditions.

Größe | Size: 1090 × 600 × 1150 mm

Boxgröße | Box size: 950 × 250 × 640 mm



PRAKTISCHE ABLAGEFLÄCHE
ZUM EINTOPFEN
PRACTICAL WORK SURFACE
FOR POTTING

KANN LEICHT VON EINEM PLATZ
ZUM ANDEREN GEROLLT WER-
DEN – DER SONNE ENTGEGEN
CAN BE EASILY WHEELED TO
DIFFERENT PLACES – TOWARDS
THE SUN

OPTIONALER ARBEITSBEREICH AM GRIFF
OPTIONAL WORKSPACE ON HANDLE

PULVERBESCHICHTETES STAHLROHR
POWDER-COATED STEEL PIPE



Michael Hall Larsen

Naturkindergarten-Experte, Dänemark
Nature kindergarten expert, Denmark

Eine frühe, sinnvolle pädagogische Interaktion zwischen dem Kind und der Natur ist sowohl für die Entwicklung des Kindes als auch für die der Natur sehr wertvoll. Was wir in der Kindheit lernen zu pflegen, wird sich als Werte verankern und unsere zukünftigen Handlungen und Verhaltensweisen leiten.

An early meaningful pedagogical interaction between the child and nature is very valuable for both the child and nature's development. - What we in childhood learn to care for will plant itself as values and guide our future actions and behaviors.



KANN MIT EINEM
FAHRRADSCHLOSS
GESICHERT WERDEN
CAN BE SECURED
WITH A BIKE LOCK

DIE TRANSPARENTE FOLIE KANN EINFACH HOCHGEROLLT WERDEN | THE TRANSPARENT FOIL CAN BE ROLLED UP EASILY





NOCH STABILER VERARBEITET
MANUFACTURED EVEN MORE STABLE



64350

BUGGY

Der Buggy von beleduc ist das perfekte Gefährt für alle geliebten Puppen und Kuscheltiere und auch Kinder. Ideal für alle Mutter-Kind Rollenspiele. Durch die hohe Stabilität (bis 50 kg) können sich die Kinder gegenseitig auf dem Spielplatz und Außengelände fahren. Durch die hinteren mitlenkenden Rollen ist der Buggy unglaublich wendig und meistert auch enge Kurven. Das bringt in der Nutzung Fahrspaß für den Fahrer sowie für den Schiebenden. Bei kleinen, engen Kurven bieten die ausgestellten Griffe Halt und der Geschobene hat den Eindruck den Buggy selbst zu steuern.

The Buggy by beleduc is the best transportation for all loved dolls and cuddly toys. Ideal for mother-child-role play which children love. Due to its durability (up to 50 kg) children can also drive each other around on the playground. Our Buggy is very agile due to the rotatable backwheels and small turns are no problem. Amazing playing fun for both driver and passenger is guaranteed. In smaller, tight turns the handles on the sides offer great stability and the one being pushed feels as if they are directing the Buggy themselves.

Größe | Size: 600 × 630 × 475 mm
 Boxgröße | Box size: 890 × 550 × 275 mm



**INDOOR
&
OUTDOOR!**

**UNGLAUBLICH WENDIG DURCH
MITLENKENDE ROLLEN HINTEN!**
**INCREDIBLY MANOEUVRABLE
DUE TO ROTATABLE BACKWHEELS**

**FUSS-STÜTZE UND GRIFFE BIETEN
SICHEREN HALT**
**FOOTHOLD AND HANDLES
FOR MAXIMUM SAFETY**



VIELSEITIG UND WENDIG!
VERSATILE AND AGILE!



UNBEDINGT ANSCHAUEN! | HAVE A LOOK!

Kids Video



EXTREM WENDIGE HINTERRÄDER
EXTREMELY FLEXIBLE BACKWHEELS



BIS 50 KG BELASTBAR!
DURABLE UNTIL 50 KG!



NOCH STABILER VERARBEITET
MANUFACTURED EVEN MORE STABLE

64360

KARUSSELL

Das Sitz-Karussell bietet die Möglichkeit, aktiv Schwung zu geben oder sich am zusätzlichen Haltegriff einfach nur festzuhalten. Kinder können sich gegenüber sitzen und gemeinsam Spaß haben und der Standort kann einfach jederzeit gewechselt werden, dort hin wo das Drehen stattfinden soll. Das Karussell fördert bei den Kindern den Gleichgewichtssinn und die Körperkoordination.

CAROUSEL

The carousel offers the possibility to actively make it go round or hold on safely to the hand-hold. Children can sit opposite each other and play together. The carousel can be easily moved around easily transported to different play areas. Our carousel trains children's sense of balance and body coordination.

Größe | Size: 850 × 850 × 360 mm

Boxgröße 1 | Box size 1: 925 × 115 × 908 mm

Boxgröße 2 | Box size 2: 330 × 335 × 406 mm



**INDOOR
&
OUTDOOR!**

MOBILES SITZ-KARUSSELL
COMFORTABLE, MOBILE
SIT-ON CAROUSEL
FÖRdert DEN GLEICHGEWICHTSSINN
SOWIE DIE KÖRPERKOORDINATION
TRAINS CHILDRENS' SENSE OF
BALANCE AND BODY COORDINATION
FÜR BIS ZU 4 KINDER NUTZBAR
CAN BE USED BY UP TO 4 KIDS



EIN KIND HÄLT SICH
FEST, DAS ANDERE
DREHT! | ONE CHILD
CAN HOLD ON, THE
OTHER CAN TURN THE
CAROUSEL ROUND

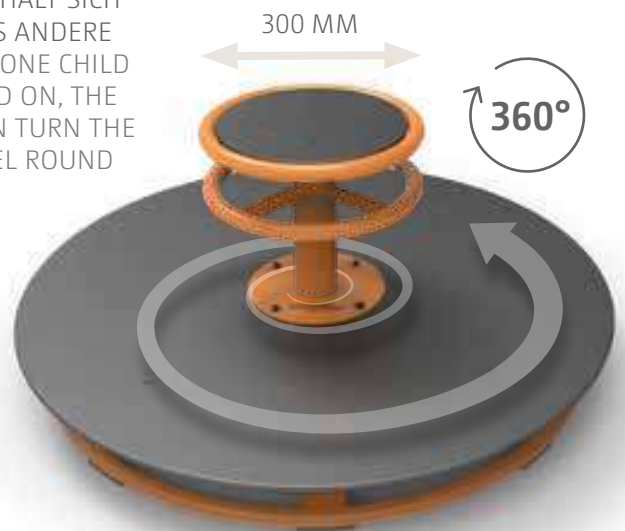

DIE STABILE MITTELACHSE
DREHT SICH AUF EINEM
KUGEL-ROLLENLAGER.
THE STURDY CENTRAL AXIS
TURNS ON A BALL ROLLER
BEARING.





68230

MULTI-BÄNKE, 4ER SET

Die Multibänke sind ideal überall da, wo Kinder spielen oder sich kleinere Gruppen zum Beispiel zum Rollenspiel oder Pause machen treffen. Ideal für alle Veranstaltungen. Auch für Erwachsene geeignet. Einfach aufgeklappt und los geht's! Robuster pulverbeschichteter Rahmen, strapazierfähig und wetterbeständig. Leicht und schnell zusammenklappbar und platzsparend zu verstauen. Wird im 4er Set mit Aufbewahrungstaschen geliefert. Inkl. Tragegriff – leicht und bequem zu tragen.

SET OF 4 MULTI BENCHES

The multi benches are perfect everywhere where several children come together for example for outdoor and indoor play or during break time. Simply unfold the bench and take a seat! The robust, powder-coated steel frame is durable and weather-resistant. The benches are foldable for practical, space-saving storage and each set contains 4 benches and 2 storage bags.

Größe | Size: 365 x 1100 x 330 mm

Boxgröße | Box size: 1120 x 175 x 495 mm



**INDOOR
&
OUTDOOR!**

3+

ÜBERALL DA, WO SIE
GEBRAUCHT WERDEN!
WHEREVER THEY ARE NEEDED!

**4ER SET
SET OF 4**

SITZ AUS TEXTILGEWEBE –
WETTERFEST
TEXTILE FABRIC SEAT
– WEATHER RESISTANT

LEICHT UND SCHNELL
ZUSAMMENKLAPPBAR
QUICK AND EASY TO FOLD





67000

BALANCIERSCHEIBE

Runde um Runde steigt das Vergnügen mit der Balancierscheibe. Diese eignet sich besonders gut, um die Balance und das eigene Körpergefühl wahrzunehmen und zu trainieren. Egal ob sitzend oder liegend, die Balancierscheibe ist eine Herausforderung für jedes Kind.

TURNING TABLE

With our "Turning Table", the fun increases round by round. It is particularly suitable for training and experiencing balance and body perception. Whether sitting or lying, the "Turning Table" is a challenge for every child.

Größe | Size: 550 x 550 x 270 mm
Boxgröße | Box size: 600 x 600 x 330 mm

3+ FOB



67120

TURN & SWING

Der Turn & Swing macht nicht nur jede Menge Spaß beim Schaukeln und Drehen, sondern trainiert körperliche Fertigkeiten und unterstützt optimal das Krafttraining von Kindern. Zwei integrierte Kugellager in der Aufhängung ermöglichen eine Drehung um die eigene Achse. Die mitgelieferte Schlaufe kann Drinnen und Draußen an einer geeigneten Halterung, Gerüst oder Baum angebracht werden. Das Spielgerät wird mittels Karabiner befestigt und ist somit eine große Bereicherung für jedes Klettergerüst. Das robuste Seil ist zusätzlich gegen Abrieb geschützt.

Two integrated ball bearings in the suspension enable rotation around the own axis. The included sling can be fastened to a suitable fixture, scaffold or tree and the toy can be fixed with a carabiner. Practical variable height settings enable the usage seated or hanging freely. The robust rope is additionally protected against abrasion and wear and the connection to the bearing was sealed as protection against dirt and water.

Größe | Size: 2500 x 460 x 95 mm
Boxgröße | Box size: 470 x 80 x 135 mm

3+ FOB



TRAINIERT PERFECT DIE BALANCE
PERFECTLY TRAINS BALANCING SKILLS

TIPP!





Unser beleduc-Tipp

TRANSPORTWAGEN



MIT ZUSÄTZLICHEM
KLEMMSCHUTZ
WITH ADDITIONAL
ANTI-TRAP PROTECTION

68042

TRANSPORTWAGEN

Der stabile und wetterfeste Transportwagen eignet sich prima zum Verstauen von Sandspielzeug, Bällen und weiteren Sportutensilien. Die abklappbare Seitenwand ermöglicht eine kindgerechte Nutzung. Mit seinen vier feststellbaren Lenkrollen ist die Positionsveränderung des Transportwagens sowohl in Turnhallen als auch im Freigelände kein Problem. Der zusätzliche Klemmschutz bietet optimale Sicherheit.

TRANSPORT CAGE

The sturdy and weatherproof Transport Cage is perfect for storing sand toys, balls and other sports equipment. One side panel can be folded in half and allows easy access for the children. With its lockable castors the position of the Transport Cage can be easily moved around in the gym as well as on outdoor areas. The additional anti-trap protection ensures optimum safety.

Größe | Size: 1120 × 706 × 830 mm
Boxgröße | Box size: 1140 × 730 × 185 mm

FOB



1120 MM

INNEN & AUSSEN NUTZBAR!
INDOOR & OUTDOOR USABLE!

**EXTREM STABIL UND GUT
IM HANDLING!**
*EXTREMELY STABLE AND
EASY TO HANDLE!*

Our beleduc-tip

TRANSPORT CAGE



64160

BAGGER

Mit dem Bagger geht es rund im Sandkasten! Der Sitz mit Schaufelvorrichtung ist 360° drehbar, sodass mit der robusten Stahlschaufel an allen Seiten gebaggert werden kann. Die Standfüße können sich im Sand richtig eingraben und sorgen somit für einen sicheren Stand.

DIGGER

With the "Digger" kids rock the sandbox! The seat offers a 360° turning function, so that children can dig from all sides with the robust steel shovel. The feet provide a secure footing, as they can dig deeply into the ground.

Größe | Size: 600 × 600 × 900 mm

Boxgröße | Box size: 630 × 520 × 285 mm

3+ FOB

EXTREM STABIL
EXTREMELY STABLE



64090

SCHUBKARRE

Die große und stabile Schubkarre ist aus keinem Sandkasten wegzudenken. Das hohe Fassungsvermögen macht es möglich, größere Mengen Sand zu beladen, zu transportieren und wieder zu entladen. Kleine Sandburgenbauer kommen so auf ihre Kosten.

WHEELBARROW

The big and solid wheelbarrow cannot be missed in any sandbox. Its high capacity makes it possible to load, transport and unload large amounts of sand. Thus, the needs of little sand castle builders are well catered for.

Größe | Size: 885 × 405 × 430 mm

Boxgröße | Box size: 805 × 425 × 355 mm

4+ FOB

spiel gut®
vom arbeitsausschuß
kinderspiel + spielzeug
ausgezeichnet
recommended

25 l
Füllmenge
Volume





CREATIVE WORLDS & GIFTS

Großer Bastelspaß und kreative Geschenkideen.
Great DIY fun and creative gift ideas.





Kratzposter XL | Dieses Produkt
finden Sie auf Seite 226
Scratch poster XL | You can
find this product on page 226

**MEHR AUF
SEITE 226**
**MORE ON
PAGE 226**



SMOOTH PAINTER



je | each

6x



72
tlg. | pcs

52040 · XXL GROUP SET OF 72 SMOOTH PAINTER

Boxgröße | Box size: 345 × 230 × 70 mm



MIT GLITZEREFFEKT
WITH GLITTER EFFECT

52050 · SET OF 12 SMOOTH METALLIC PAINTER

Boxgröße | Box size: 292 × 140 × 22 mm

je | each
2x

VERSTELLBARE MINE
DURCH EINFACHES DREHEN!
TIP EASILY ADJUSTABLE
BY TURNING!



52060 · SET OF 12 SMOOTH TEXTILE PAINTER

Boxgröße | Box size: 292 × 140 × 22 mm

SMOOTH PAINTER

Die Smooth Painter von beleduc bieten alle Vorzüge von Plakatfarben, kommen jedoch ganz ohne Kleckern und Schmierer aus. Zum Auftragen der Farbe bedarf es kein Wasser oder Pinsel. Die neuen Stifte sind einfach und absolut sauber in der Verarbeitung auf Papier, Pappe, Holz und vielen weiteren Materialien. Die Farbe ist schnelltrocknend, reißt und knittert nicht. Smooth Painter eignen sich daher ideal für die Anwendung im Kindergarten und Schule.

The Smooth Painters offer all the advantages of poster colours but without any spilling and smudging. No water or brush is needed for using the solid colours. The new pens are simple and completely clean when used on paper, cardboard, wood and many other materials. The colour is fast-drying, does not rip or crease, which makes Smooth Painter ideal for usage in kindergarten and schools.

Größe je | Size each: Ø 20 × 92 mm

3+ !1



52030

**BELEDUC GELSTICK, 12ER SET
SET OF 12 BELEDUC GELSTICKS**

Mit unserem großen Klebestift lassen sich Papier, Karton und Fotos perfekt kleben.

With our big glue stick you can glue paper, cards and photos perfectly.

Größe je | Size each: Ø 30 × 121 mm



**12ER SET
SET OF 12**



[www.beleduc.de/
videos](http://www.beleduc.de/videos)



52020

**REGENBOGENSTIFTE, 24ER SET
SET OF 24 RAINBOW PENCILS**

Dieser Zauberstift beinhaltet mehrere Farben auf einmal.

This magic pen contains various colours at once.

Größe je | Size each: Ø 10 × 175 mm



**24ER SET
SET OF 24**

TIPP!



40152

**TEXTILSTIFTE, 10ER SET |
SET OF 10 TEXTILE MARKERS**

Eines unserer beliebtesten Produkte – langlebig und super einfach in der Anwendung.

One of our best selling items – suitable for durable use and easy to handle.

Größe je | Size each: Ø 16 × 110 mm

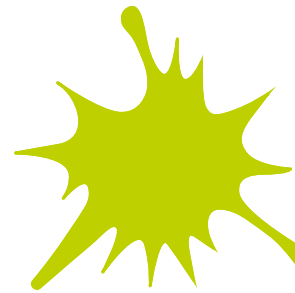

52010

**MULTIPENS, 10ER SET |
SET OF 10 MULTIPENS**

Abwaschbar auf: Glas, Kunststoff und Keramik.
Washable on: glass, plastic and ceramics.

Größe je | Size each: Ø 16 × 130 mm





FLYING COLOURS



BEST SELLER

**HIGHLIGHT! ABNEHMBARE UND ABWASCHBARE SCHUTZWANNE
REMOVABLE AND WASHABLE PROTECTIVE TRAY**

 **SCAN ME**
Kids Video



A 68500

FLYING COLOURS

Mit der Farbenscheuler lassen sich auf einfache Art und Weise ausdrucksstarke und dynamische Bilder zaubern. Vor oder beim Drehvorgang wird einfach Farbe auf das Papier gegeben und die Fliehkraft lässt tolle Muster entstehen.

The colour centrifuge gives children a simple way of conjuring up expressive, dynamic works of art. Paint is simply applied to the paper before or during the spinning process, and the centrifugal force creates super patterns.

Größe | Size: 690 x 500 x 130 mm



B 68501

**20 x PLASTIKFLÄSCHCHEN + 5 x SCHABER
SET OF 20 BOTTLES + 5 SCRAPERS**

Größe | Size:
150 x 45 x 45 mm (Flaschen | bottles)
115 x 18 x 10mm (Schaber | scrapers)



JEDES BILD EIN UNIKAT | EVERY PICTURE IS UNIQUE!



TOLLES ERGEBNIS MIT GLITZER | GREAT ARTWORKS WITH GLITTER



ES ENTSTEHEN IMMER WIEDER NEUE UND KREATIVE MOTIVE!
NEW AND CREATIVE MOTIFS ARE DESIGNED EACH TIME

ZAUBERE AUSDRUCKSSTARKE, DYNAMISCHE BILDER
CONJURING UP EXPRESSIVE, DYNAMIC WORKS OF ART

2 MAGNET-HALTER INKLUSIVE – ZUR FIXIERUNG DES PAPIERS
2 MAGNETIC HOLDERS INCLUDED – FOR FIXING THE PAPER

ZUBEHÖR – EQUIPMENT

Ideal, um die Kunstwerke zu trocknen!

Ideal for drying works of art!

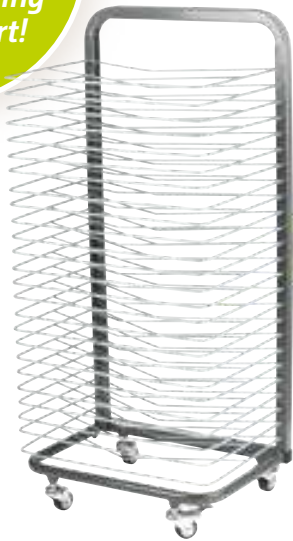

68120 • TROCKENWAGEN

Der Trockenwagen hält mit seinen 25 Lagen Platz für 25 Blätter im DIN A3- oder 50 im DIN A4-Format bereit. Mit den vier praktischen und zwei feststellbaren Rädern kann er im Raum flexibel verschoben werden und sorgt für einen festen Stand.

DRYING SHELF

The Drying Shelf has 25 layers and holds 25 sheets in DIN A3 format or 50 sheets in DIN A4 format. Due to four practical wheels, two of which are lockable, it can be flexibly moved in a room while having a secure stand.

Größe | Size: 460 × 330 × 980 mm

FOB

C 68502

200 BLATT PAPIER

200 PCS OF PAPER (150G/M²)

Größe | Size: Ø 350 mm, 150 g/m²



4+

FOB

!1



68505 • TRANSPARENTE FOLIE - 50ER SET

Transparente Kreisfolie – ideal geeignet, um weitere kreative Kunstwerke mit der beleduc Flying Colours umzusetzen. Hier können phantasievolle Motive entstehen oder Fensterbilder gestaltet werden. Die Folie ist leicht zu schneiden und kann so in andere Formen gebracht werden. Zum einfachen herausnehmen trennt eine Schutzfolie die einzelnen Folien. Material: PET (umweltfreundlich und kann recycelt werden)

TRANSPARENT FOIL – SET OF 50 FOILS

Transparent round foil – ideal for creating even more amazing artworks with beleduc's Flying Colours. This foil can be used to design fantastic motifs to decorate windows and more. It can also be cut into different shapes. A protective layer separates the individual foils for easier handling. Material: PET (eco-friendly and recyclable)

Größe | Size: Ø 350 mm

Stärke | Thickness: 0,02 mm (mit Schutzfolie | with protective foil)

3+



Winter



A 50310
FOTOAUFSTELLER »WINTER«
Ein Bild sagt mehr als tausend Worte. Dieser Fotoaufsteller verschönert in der Winterzeit euer Zuhause.

PHOTO FRAME »WINTER«
A picture is worth a thousand words. This Photo Frame embellishes your home during winter time.
Größe | Size: 120 × 40 × 155 mm

B 50340
ANHÄNGER »STERNE«, 3ER SET
Ob als Schmuck für den Weihnachtsbaum oder als Geschenkanhänger verwendet – diese Anhänger passen perfekt zur Weihnachtszeit.

SET OF 3 STAR PENDANTS
Whether as a decoration for the Christmas tree or as a gift pendant – these pendants are perfectly suitable for the Christmas season.
Größe | Size: 60 × 100 mm

C 50250
LATERNE
Ein tolles Lichterfest für die Sinne. Ob für Haus oder Garten, einen Lampionumzug oder als Weihnachtsdekoration – unsere Laterne eignet sich für alle Gelegenheiten.

LANTERN
Wonderful festival of lights for the senses. Whether for house or garden, a lampion walk or as a Christmas decoration – our lantern is just perfect for any occasion.
Größe | Size: 120 × 120 × 140 mm

A 50530

WINTERWUNDERLAND

Dieses Winterwunderland steht mit zwei Bäumen und einem Schneemann auf einer Holzplatte. Das Produkt ist blanko und kann kreativ verziert und bemalt werden. Ideales Geschenk in der Adventszeit.

CHRISTMAS LANDSCAPE

This winter wonderland stands with two trees and a snowman on a wooden board. The product is blank and can be creatively decorated and painted. Ideal gift in the advent season.

Größe | Size: 160 × 125 × 9 mm



B 50540

ADVENTSKERZENHALTER

Dieser Adventskerzenhalter ist blanko aus Holz. Er kann beliebig verziert werden und wird so zum idealen Geschenk in der Weihnachtszeit. Bis zu vier Teelichter haben finden hier Platz. Auch als Adventskranz eine schöne kreative Alternative.

TEALIGHT HOLDER "ADVENT"

This advent candle holder is blank and made of wood. It can be decorated as you like and is therefore the ideal gift for the christmas season. There is space for up to four candles. Also a beautiful creative alternative as an advent wreath.

Größe | Size: 220 × 65 × 10 mm



Winter



B



* Ohne Dekoration | Without decoration



Winter



A



A 40742
TEELICHTHALTER »STERN«
TEALIGHT HOLDER »STAR«

Größe | Size: 135 × 135 × 10 mm



135 MM

B 50230
TEELICHTHALTER »STERNSCHNUPPE«
TEALIGHT HOLDER »SHOOTING STAR«

Größe | Size: 200 × 100 × 8 mm



B

C 50200
LICHTERHAUS
Mit Pergamentpapier innen beklebt und einem LED-Teelicht versehen, wird daraus ein tolles Lichterhaus.

HOUSE OF LIGHTS
Laminated with parchment paper from the inside and equipped with a LED tealight, it will become a fantastic House of Lights.

Größe | Size: 110 × 100 × 145 mm



200 MM

* Ohne Dekoration | Without decoration



145 MM

C



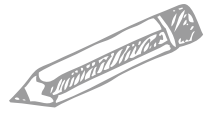
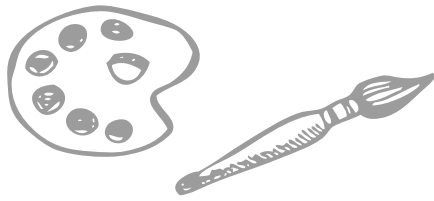

A 68050

MALSCHÜRZE, 550 MM

Unsere Malschürze ist in zwei unterschiedlichen Größen erhältlich. So erhält jeder Picasso seine Schutzkleidung beim Malen des nächsten Meisterwerks. Auch beim Basteln schützt die Malschürze zuverlässig die Klamotten der Kinder vor Wasser, Farbe und Kleber.

IN ZWEI GRÖSSEN ERHÄLTlich!
AVAILABLE IN TWO SIZES!

A



PAINT APRON, 550 MM

Our paint apron is available in two different sizes. So every Picasso gets his protective clothing when painting the next masterpiece. The paint apron also reliably protects the children's clothes from water, paint and glue when crafting.

B



Größe | Size: 1000 x 550 mm

3-5 FOB

B 68060

MALSCHÜRZE, 650 MM
PAINT APRON, 650 MM

Größe | Size: 1250 x 650 mm

6-8 FOB

C 53183

WINDSPIEL »SCHMETTERLING«

Das Windspiel ist sowohl Indoor als auch Outdoor ein Hingucker – ideal für die Kindergartengruppe, das Kinderzimmer oder den Balkon bzw. Terrasse. Durch die mitgelieferte Aufhängung können Sie den Schmetterling sofort überall aufhängen. Sowohl der Schmetterling, als auch der untere Teil können individuell bemalt werden. Geeignet sind hier die beleduc Textilstifte.

WIND TWISTER »BUTTERFLY«

The wind twister is an eye-catcher both indoors and outdoors – ideal for the kindergarten group, the children's room or the balcony or terrace. With the included suspension, you can immediately place the butterfly anywhere. Both the butterfly and the lower part can be individually painted – for example with the beleduc textile pencils.

Material: Polyester

Größe | Size: 1200 x 200 mm

Spring

TOLLES DIY WINDSPIEL – HIER WIRD JEDES TEIL EIN UNIKAT!
GREAT DIY WIND TWISTER – EACH BUTTERFLY IS UNIQUE!

BEST SELLER

Ø 200 mm



C

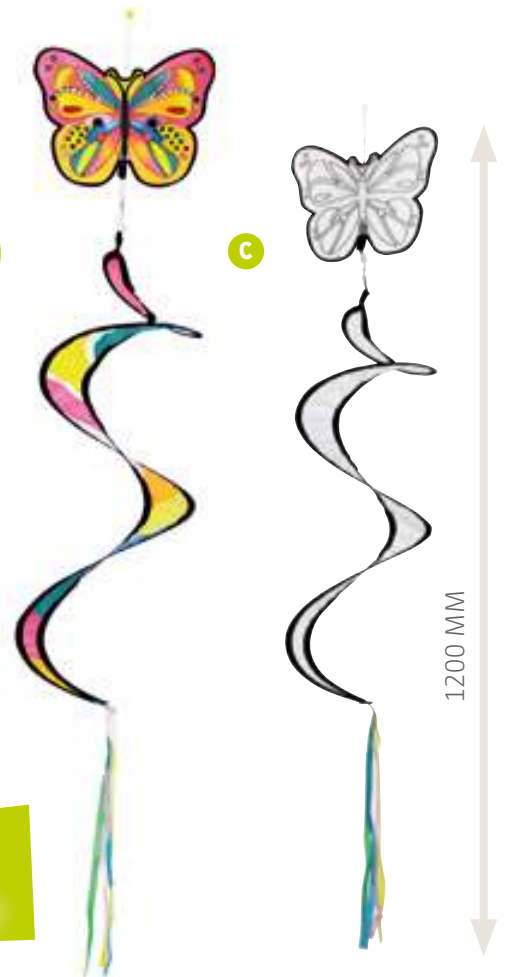

Frühling



KRATZPOSTER XL

53051

DIY KRATZPOSTER, XL

Wie durch Zauberhand entstehen bunte Bilder oder Muster. Einfach mit dem Holzstift loskratzen und Spaß haben. Hier sind der Kreativität keine Grenzen gesetzt. Das Besondere: Die Poster können mit den Klebepunkten ganz leicht an Wänden oder Türen angebracht werden.

DIY SCRATCH POSTER, XL

Colourful images and designs are created like magic. Simply scratch with the wooden pencil and have fun. The creativity can roam freely with our new XL posters. For special effect: Use the included adhesive dots to fix posters to doors and walls and create large artworks.

Größe | Size: 750 × 520 mm

4+ !1

LEICHTE ANBRINGUNG MIT KLEBEPUNKTEN | EASY TO FIX WITH THE ADHESIVE DOTS



8 POSTERBÖGEN
24 HOLZSTIFTE
32 KLEBEPUNKTE

8 POSTERS
24 WOODEN PENS
32 ADHESIVE
DOTS



IDEAL FÜR DIE GRUPPE
IDEAL FOR THE GROUP



→
BIS ZU 6M
LÄNGE!
UP TO 6M
LENGHT!



SCRATCH POSTER, XL

A 53080

KRATZBLOCK, RAINBOW ARTS

Dieses Geschenk ist einfach toll und es entstehen großartige Kunstwerke in Regenbogenfarben. Die Kinder lieben es! Einfach loskratzen und kreativ werden. 12 Seiten + Holzstift.

SCRATCH BOOK, RAINBOW ARTS

With this amazing gift item, great artworks are created in rainbow colors. The children love it! Just scratch and get creative. 12 sheets + wooden pen.

Größe | Size: 140 x 200 x 12 mm

4+ 

B 53050

KRATZBILDER, CREATING ARTS

Dieser Notizblock überrascht durch eine Schicht aus Regenbogenpapier unter der mattschwarzen Oberfläche. In einer Packung sind 200 Blatt Papier auf denen mit den 24 enthaltenen Holz-Kratzstäben gemalt werden kann – ganz ohne Tinte oder Buntstifte. Die leuchtenden Farben verstecken sich unter der schwarzen Oberfläche, so dass bunte Bilder gemalt bzw. gekratzt werden können.

SCRATCH PICTURES, CREATING ARTS

This notepad surprises with a layer of colourful rainbow paper underneath the matte black surface. Each pack contains 200 sheets of paper, which can be decorated with the 24 included wooden sticks – without using any ink or crayons. The bright colours are beneath the black top layer so that colourful pictures can be scratched and drawn onto the surface.

Größe | Size: 90 x 90 x 58 mm

4+ 

DIN A5 FORMAT



12 SEITEN
12 SHEETS



A

12 SEITEN INKL. HOLZSTIFT
12 SHEETS INCL. WOODEN PENCIL

**BEST
SELLER**



B

IDEALE GRUPPENBESCHÄFTIGUNG | IDEAL GROUP ACTIVITY



NOTIZEN UND KREATIVER SPASS
NOTES AND CREATIVE FUN

200 SEITEN, 24 HOLZSTIFTE
200 SHEETS, 24 WOODEN PENCILS

GESCHENKE – GIFTS



**BEST
SELLER**

A



A 53140

HELFERMONSTER »KALT & WARM«

Vier lustige Monster kühlen bei Bedarf und werden im Winter zum warmen Wegbegleiter. 4 Farben, gemischt gepackt

POCKET MONSTER »COLD & WARM«

Four Funny monsters can cool when needed and during the cold season the little monsters become warming companions. 4 colours, mixed packed

Material: PVC | plastic
Größe | Size: 95 × 120 × 15 mm

3+ **!**₁

B 53181

SPRINGMONSTER, 6ER SET

Lass die Monster hüpfen und wackeln! Ein kleines Geschenk für jede Menge Spaß! In 6 verschiedenen Ausführungen.

JUMPING MONSTERS, SET OF 6

Let the monsters shake and jump! A small gift for loads of playing fun! In 6 different versions.

Material: Kunststoff PVC/PP | plastic
Größe: bis zu 6 cm | Size: up to 6 cm

5+ **!**₁

C 53187

MAGNETISCHE LESEZEICHEN

Praktisch, um ganz einfach die Seite im Lieblingsbuch zu markieren! Die beiden schönen Kindermotive machen Spaß und wecken die Lust am Lesen. 2 Motive, gemischt gepackt.

MAGNETIC BOOKMARK

Handy for quickly marking a page in your favourite book! The 2 colorful, attractive motifs encourage children to read and enjoy little adventures. 2 styles, mixed packed.

Größe | Size: 30 × 100 mm

3+ **!**₄



**6ER SET
SET OF 6**

B

((JUMP!))

SELBSTAUSLÖSENDER
SPRUNGMECHANISMUS
SELF-RELEASING JUMPING
MECHANISM



60 MM

**2
DESIGNS**

»LESERATTE & BÜCHERWURM«
»READING RAT & BOOKWORM«



C



100 MM

A 53120

AUFBLASBARER »SUPER-SOFTBALL«

Ideal für alle Ballspiele und Übungen sowie als Geschenkartikel und Osternest geeignet.

INFLATING »SUPER SOFT BALL«

Perfect for all ball games and exercises, as gift item or deflated as Easter basket.

Material: Kunststoff PVC | plastic

Größe | Size: Ø 230 mm

3+ **!**₁



B 53180

TASCHENLAMPE „ENTDECKER LED-LICHT“

Dieser ideale Entdeckungstour-Begleiter darf bei keiner Nachtwanderung oder keinem Versteckspiel fehlen. Mit praktischem Karabiner-Haken. 4 Farben (lila, grün, blau, gelb) gemischt gepackt.

FLASHLIGHT „DISCOVERY LED-LIGHT“

This ideal discovery tour companion must not be missing during any night hike or hide-and-seek game. With practical carabiner hooks. 4 colours (lilac, green, blue, yellow) mixed packed.

Größe | Size: Ø 32 × 97 mm

3+ **!**₁



4 FARBEN
MIT KARABINER
4 COLOURS
WITH CARABINER

B



LED

C 50430

GUMMITWIST »KÄNGURU«

Mit diesem Hüpfgummi haben Kinder einfach immer Spaß! 4 Farben, gemischt gepackt.

TWISTY »KANGAROO«

Children are always having fun with this elastic twist! 4 colours, mixed packed.

Größe | Size: 111 × 2700 × 90 mm

3+ **!**₂



C



D 53185

LED STIRNLAMPE

Mit der Stirnlampe von beleduc sind kleine Entdecker auch bei Dämmerung und Dunkelheit gut vorbereitet. Die Stirnlampe gibt es in blau, rot und grün (mixed packed). Keine Batterien (3x AAA) im Lieferumfang enthalten.

LED HEAD LAMP

Little explorers are prepared for dawn and darkness with the beleduc head lamp. The head lamp is available in blue, red and green (mixed packed). Batteries (3 × AAA) are not included.

Boxgröße | Box size: 42 × 65 × 30 mm

3+ **!**₄



LICHT IN 3
STUFEN
EINSTELLBAR
LIGHT USABLE IN
3 MODES



D

FLEXIBEL
VERSTELLBARES
STIRNBAND
FLEXIBLE, ADJUSTABLE
HEADBAND

KLICK DICH DURCH DIE NEUE ONLIN VON

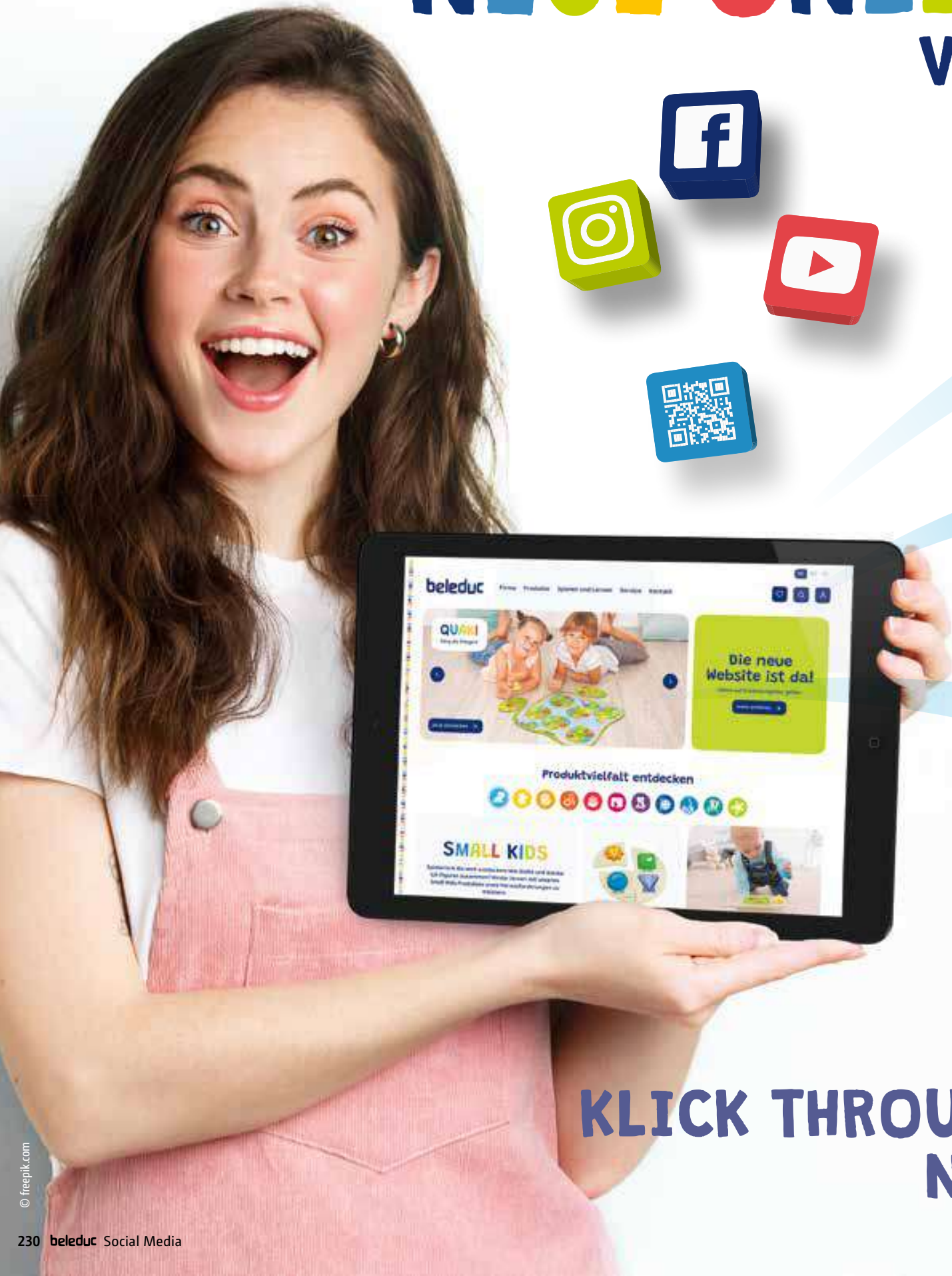

KLICK THROUGH NEW

E WELT BELEDUC!

Mit verbesserter
Suchfunktion

With improved
searching function



Technische Daten
Technical data

BLOG- UND
EXPERTENBEITRÄGE
BLOG AND
EXPERT POSTS

Spielanleitung
Game instruction

Video

Download Bilddaten
Download image data

ZUSATZMATERIAL ZUM DOWNLOAD

Ausführliche
Produktbeschreibung
Detailed product
description



ADDITIONAL MATERIAL FOR DOWNLOAD

NEW!

THE ONLINE WORLD OF BELEDUC!

KREATIV

mit beleduc



* **AUSMALBILDER**
COLOURING PICTURES

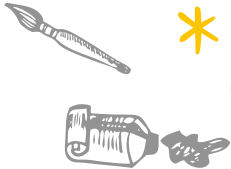

* **DIY IDEEN**
DIY IDEAS



* **BASTELVIDEOS**
CRAFTY VIDEOS

* **DOWNLOAD HIER**
DOWNLOAD HERE



UPCYCLING MIT BELEDUC

Wir basteln ein Insektenhotel in der Dose!



- * **DAS BENÖTIGST DU DAFÜR:**
- Saubere Konservendosen
 - Material zum Verschönern der Dose
z. B. Wolle oder Papierschmispel
 - Schere & Bastelkleber oder Kleister, Kabelbinder (lang)
 - Schraubendreher und Hammer
 - Stifte, Kreppband, evtl. Filz

- * **FÜLLMATERIAL:**
- Röhren (z.B. Bambusröhren aus dem Baumarkt oder super für Wildbienen)
 - Schmetterlinge mögen dünne Zweige
 - Marienkäfer und Florfliegen bevorzugen Holzwole
 - Zapfen jeglicher Art sind eher weniger gut geeignet, können aber als Lückenfüller verwendet werden

LOS GEHT'S...



Hierbei stellen wir dank an die Neue Energie, Leber, Wöhren, Natter, Co. die Herstellung der Bilder ihrer DIY-Anleitung. www.NeueEnergie.de

FERTIG!

TIPP
MAN KANN INSEKTENHOTELS AUCH AUS ALTEN TASCHEN BASTELN

JETZT KÖNNEN DIE INSEKTEN EINZIEHEN.

beleduc



Alle Materialien gibt es in Deutsch und Englisch.
Andere Sprachen?
Sprechen Sie uns gerne an!

All materials are available in German and English.
Other languages?
Feel free to contact us!



CREATIVE
with beleduc

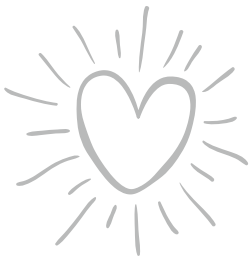

* ZUSATZMATERIAL ADDITIONAL MATERIAL

Wir bieten auf unserer Website, passend zu den Themen verschiedener Spiele, Puzzle, Outdoor- und Indoor-Artikel, tolles Zusatzmaterial zum Download an. Experimente, Tierwissen, ein Fröbeldiplom, Pflanzkalender und vieles mehr stehen für Sie bereit.

Einfach Downloaden und Ausdrucken, fertig!

On our homepage you will find a lot of extra material and tools for free downloading. They have been specially designed according to the topics of our different games, puzzles, indoor and outdoor products. Experiments, animal knowledge, a Froebel diploma, planting calendar and much more are waiting for you.

Easily download, print and ready!

NATURE-KNOWLEDGE Species conservation

Why are zoos so important?

Zoos play a very important role in species conservation. Zoos are considered scientific institutions for the conservation of species. They preserve rare and endangered animal species. Breeding programmes preserve animal species that would otherwise become extinct in the wild. In certain species conservation programmes, animals are also reintroduced into the wild and their natural habitat. Zoos also do important educational work by educating people about the animal species and their habitats through guided tours and information in the zoo.

One of the main goals of zoos is to preserve the diversity of different animal species through breeding. This research can help to understand the behaviour, biology and diseases of endangered species.

Animal sponsorship

Beleduc has taken on an animal sponsorship for a katta. With this sponsorship, the work of the zoo can be supported and therefore everyone can make a contribution to species conservation and research. Zoos are always happy to receive support in order to give the animals the best possible life and to maintain species conservation.

The motto of Frankfurt Zoo „Experience animals - preserve nature“ is the general goal of the work for education and public relations to raise the environmental awareness of zoo visitors and to communicate the different levels of biodiversity together to prevent the loss of biodiversity. Visitors gain an understanding of the animals' needs. As a cultural institution, zoos fulfil a number of socially relevant tasks, which are summarised under the four pillars of zoo biology - recreation, education, research and conservation. As the pressure on ecosystems increases, the role of the zoo in educating visitors about biodiversity conservation becomes more important.

TOPTRIKE WAAGE Indoor & Outdoor Fun!

Probieren es aus!

EXPERIMENTE 1 2 3

*** ERSTES ZÄHLEN UND FARBENLEHRE**
Bitten Sie die Kinder, Bausteine oder etwas Ähnliches in der Wanne zu sammeln. Nun können Sie die Bausteine zum Beispiel nach Farbe, Größe oder Form sortieren. Anschließend bitten Sie die Kinder die Bausteine einer Farbe oder in einer bestimmten Menge in die Eimer zu füllen.

*** EXPERIMENTIER-TAG**
Jedes Kind darf an diesem Tag etwas von Zuhause mitbringen. Nun dürfen sie ihre Gegenstände miteinander vergleichen: „Ist der Teddy schwerer als das Auto?“ Bestimmt werden die Kinder staunen, wie sich die Anzeige der Waage verändert, wenn sie etwas in den Eimer legen.

*** WASSER-KARUSSELL – ERSTE PHYSIK**
Mit diesem Spiel-Experiment kommt Schwung in den Tag! Füllen Sie etwas Wasser in einen Eimer. Nehmen Sie den Eimer immer höher hin und her. Zuletzt lassen Sie ihn in einem großen Kreis vor Ihrem Körper „Karussell fahren“. Warum kippt das Wasser nicht aus dem Eimer? Erklären Sie den Kindern, dass die Kraft, die beim schnellen Kreisrennen Wasser nicht aus dem Eimer wirkt, stärker als die Schwerkraft ist. Durch die Beschleunigung will es in alle Richtungen, in die der Eimer kreist, „wegfliegen“. Also, unbedingt aufpassen! Eimer beim Kreisrennen immer gut festhalten! Vielleicht dürfen es die Kinder auch ausprobieren?

TIPPE: NUTZEN SIE DEN EXPERIMENTERTAG FÜR ERSTES ZÄHLEN!

SPLASH!

VORHANG AUF!

SEID KREATIV!

AKTIONS-THEATER XL

MACHT WAS TOLLES DRAUS!

*** DSCHUNGEL-PARTY**
Mit der passenden Deko und unseren Handpuppen kann das Puppentheater schnell in einen Dschungel verwandelt werden. Mit Affe, Papagei, Tiger und Co als Handpuppe kann die Dschungel-Party starten. Palmen und Büsche können einfach aus Tonkarton gebastelt und am Aktions-Theater befestigt werden.

EINFACH BLÄTTER AUSDRUCKEN, AUSSCHNEIDEN, AUF EINE SCHNUR ZIEHEN UND AN DEN HOLZKNIPPEN BEFESTIGEN!

*** EISVERKAUFSTAND**
Im Sommer isst jeder gerne Eis, also kann das Aktions-Theater schnell in einen

DIPLOM

DU HAST ERFOLGREICH AN DER FRÖBEL-PROJEKTWOCHE TEILGENOMMEN UND BIST NUN EIN/E ECHTE/RE FRÖBEL-EXPERTE/-EXPERTIN. GLÜCKWÜNSCH!

FRÖBEL 1782 - 1852

PLANT YOURSELF

PLANTING CALENDAR
Vegetables · Herbs · Flowers

Plant	Jan	Feb	Mar	Apr	May	Jun	Jul	Aug	Sep	Oct	Nov	Dec	Germination in days	Seed depth in cm
Vegetables														
Radishes													6-10	0.5 - 1
Kohlrabi													6-10	2
Pumpkin													8-12	2.5
Spring Onion													14-20	1-2
Carrot													10-20	2
Peppers													10-20	1
Salad (Picking Salad)													7-14	1
Herbs														
Cress													2-5	-
Lemon Balm													21-28	2
Parsley													15-25	1
Chives													14-20	2
Flowers														
Sunflower													14-20	1
Daisies													14-20	0.5
Forget-me-not													14-20	1
Marigold													8-15	2



INDEX

Alle Artikel im Überblick!
Find all items in this overview!



SMALL KIDS

18001 TRIPLE STACKER

18



Boxgröße | Box Size:
180 × 210 × 105 mm
VE (PU): 12



12 M+ 12

18004 FUNNY FOUR

18



Boxgröße | Box Size:
220 × 220 × 60 mm
VE (PU): 12



12 M+ 8

18008 ANIMAL PUZZLE

19



Boxgröße | Box Size:
245 × 160 × 50 mm
VE (PU): 12



18 M+ 14

18015 STACKY TOWER

19



Boxgröße | Box Size:
280 × 200 × 80 mm
VE (PU): 12



24 M+ 11

18021 WILD CLIMBER

20



Boxgröße | Box Size:
1190 × 775 × 120 mm
VE (PU): 1
8 Pakete/Palettenauslieferung
8 packages/pallet delivery



24 M+ 16

PUZZLES

10139 LAGEN-PUZZLE „KLEINER SCHMETTERLING“ | LAYER-PUZZLE „LITTLE BUTTERFLY“

25



Puzzlegröße | Puzzle Size:
145 × 145 mm × 20 mm
VE (PU): 20/40



24 M+ 4

10140 LAGEN-PUZZLE „KLEINER MARIENKÄFER“ | LAYER-PUZZLE „LITTLE LADYBIRD“

25



Puzzlegröße | Puzzle Size:
145 × 145 mm × 20 mm
VE (PU): 20/40



24 M+ 4

10151 „ONE WORLD“ PUZZLE

54



Puzzlegröße | Puzzle Size:
422 × 334 × 15 mm
VE (PU): 12



3+ 21

11006 MATCH & MIX „ANIMALS“

24



Puzzlegröße | Puzzle Size:
336 × 289 × 9 mm
VE (PU): 18



24 M+ 30

11007 MATCH & MIX „TRANSPORT“

24



Puzzlegröße | Puzzle Size:
336 × 289 × 9 mm
VE (PU): 18



24 M+ 30

11008 LEGEPUZZLE „ZAHLENRAUPE“ MATCHING PUZZLE „CATERPILLAR“

26



Puzzlegröße | Puzzle Size:
375 × 160 × 16 mm
VE (PU): 20



3+ 10

11009 LEGEPUZZLE „FORMENZUG“ MATCHING PUZZLE „TRAIN“

26



Puzzlegröße | Puzzle Size:
375 × 160 × 16 mm
VE (PU): 20



3+ 10

11011 XXL LERNPUZZLE „4 JAHRESZEITEN“ XXL LEARNING PUZZLE „4 SEASONS“

57



Puzzlegröße | Puzzle Size:
Ø 490 × 6 mm
VE (PU): 10



4+ 49

11012 XXL LERNPUZZLE „MEIN TAG“ XXL LEARNING PUZZLE „MY DAY“

57



Puzzlegröße | Puzzle Size:
Ø 490 × 6 mm
VE (PU): 10



4+ 49

11013 XXL FANTASY PUZZLE „INSEKTEN“ XXL FANTASY PUZZLE „INSECTS“

52



Puzzlegröße | Puzzle Size:
Ø 490 × 6 mm
VE (PU): 10



4+ 46

11014 XXL PUZZLE „WILD ANIMALS“

51

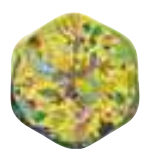

Puzzlegröße | Puzzle Size:
Ø 490 × 6 mm
VE (PU): 10



4+ 44

NEW!

11030 SORTIERPUZZLE „JAHRESZEITEN“ SORTING SET „SEASONS“

54



Puzzlegröße | Puzzle Size:
245 × 245 × 8 mm
VE (PU): 18



24 M+ 12



PUZZLES

11040
SORTIERPUZZLE „UNSER ZUHAUSE“
SORTING SET "OUR HOME" 



Puzzlegröße | Puzzle Size:
245 × 245 × 8 mm
VE (PU): 18



11050
SORTIERPUZZLE „LEBENSÄRÄUME“
SORTING SET "ENVIRONMENTS" 



Puzzlegröße | Puzzle Size:
245 × 245 × 8 mm
VE (PU): 18



11130
MATCH & MIX „KIDS“ 



Puzzlegröße | Puzzle Size:
289 × 336 × 9 mm
VE (PU): 18



11140
XXL LERNPUZZLE „FLUGHAFEN“
XXL LEARNING PUZZLE "AIRPORT" 



Puzzlegröße | Puzzle Size:
Ø 490 × 6 mm
VE (PU): 10



11150
MATCH & MIX „FANTASY“ 



Puzzlegröße | Puzzle Size:
289 × 336 × 9 mm
VE (PU): 18



11160
MATCH & MIX „ANIMAL KINGDOM“ 



Puzzlegröße | Puzzle Size:
289 × 336 × 9 mm
VE (PU): 18



11170
XXL LERNPUZZLE „DETEKTIV“
XXL LEARNING PUZZLE "DETECTIVE" 



Puzzlegröße | Puzzle Size:
Ø 490 × 6 mm
VE (PU): 10



11180
MATCH & MIX „MONSTER“ 



Puzzlegröße | Puzzle Size:
289 × 336 × 9 mm
VE (PU): 18



11190
MAGNETIC GAME
„KINDER UND TIERE DER WELT“ 



Puzzlegröße | Puzzle Size:
195 × 265 × 40 mm
VE (PU): 10



11200
XXL PUZZLE „ENTDECKE DIE WELT“
XXL PUZZLE "DISCOVER THE WORLD" 



Puzzlegröße | Puzzle Size:
Ø 490 × 6 mm
VE (PU): 10



11300
BLOCKPUZZLE „BAUERNHOF“
BLOCKPUZZLE "FARM" 



Puzzlegröße | Puzzle Size:
120 × 30 × 30 mm
VE (PU): 10



11500
COGNITO „ZUSAMMENHÄNGE“
COGNITO "RECOGNIZE ACTIVITIES" 



Puzzlegröße | Puzzle Size:
180 × 75 mm
VE (PU): 20



11510
COGNITO „ZÄHLEN UND ZAHLEN“
COGNITO "NUMBERS AND COUNTING" 



Puzzlegröße | Puzzle Size:
180 × 75 mm
VE (PU): 20



11520
COGNITO „GEGENSÄTZE“
COGNITO "OPPOSITES" 



Puzzlegröße | Puzzle Size:
125 × 75 mm
VE (PU): 20



11530
COGNITO „RÄUMLICHKEIT“
COGNITO "SPATIALITY" 



Puzzlegröße | Puzzle Size:
125 × 75 mm
VE (PU): 20



11540
COGNITO „FORMEN“
COGNITO "SHAPES" 



Puzzlegröße | Puzzle Size:
125 × 75 mm
VE (PU): 20



11550
COGNITO „TIERWELTEN“
COGNITO "ANIMAL HABITATS" 



Puzzlegröße | Puzzle Size:
180 × 75 mm
VE (PU): 20



11551
COGNITO „KATEGORIEN“
COGNITO "CATEGORIES" 



Puzzlegröße | Puzzle Size:
180 × 75 mm
VE (PU): 20



11555
HUMANICO „EMOTIONEN“
HUMANICO "EMOTIONS" 



Puzzlegröße | Puzzle Size:
Ø 160 × 4 mm
VE (PU): 20



11556
HUMANICO „5 SINNE“
HUMANICO "5 SENSES" 



Puzzlegröße | Puzzle Size:
Ø 160 × 4 mm
VE (PU): 20



11557
HUMANICO „BERUFE“
HUMANICO "PROFESSIONS" 



Puzzlegröße | Puzzle Size:
Ø 160 × 4 mm
VE (PU): 20



NEW!

PUZZLES



11560
NAWITO „HERSTELLUNG“
NAWITO „PRODUCTION“ 35

Puzzlegröße | Puzzle Size:
 Ø 120 x 4 mm
 VE (PU): 20

4+

11570
NAWITO „ENTWICKLUNG“
NAWITO „EVOLUTION“ 35

Puzzlegröße | Puzzle Size:
 Ø 120 x 4 mm
 VE (PU): 20

4+

11580
NAWITO „TIERWELTEN“
NAWITO „ANIMAL HABITATS“ 36

Puzzlegröße | Puzzle Size:
 Ø 120 x 4 mm
 VE (PU): 20

4+

11581
NAWITO „FRÜCHTE“
NAWITO „FRUITS“ 36

Puzzlegröße | Puzzle Size:
 Ø 120 x 4 mm
 VE (PU): 20

4+

11582
NAWITO „TIERARTEN“
NAWITO „ANIMAL SPECIES“ 34

Puzzlegröße | Puzzle Size:
 Ø 120 x 4 mm
 VE (PU): 20

4+

NEW!

12000
RAHMENPUZZLE „STADT“
FRAME PUZZLE „TOWN“ 27

Puzzlegröße | Puzzle Size:
 405 x 283 x 8 mm
 VE (PU): 12

3+

12001
RAHMENPUZZLE „KINDERGARTEN“
FRAME PUZZLE „KINDERGARTEN“ 27

Puzzlegröße | Puzzle Size:
 405 x 283 x 8 mm
 VE (PU): 12

3+

12002
RAHMENPUZZLE „MARKT“
FRAME PUZZLE „MARKET“ 27

Puzzlegröße | Puzzle Size:
 405 x 283 x 8 mm
 VE (PU): 12

3+

12010
RAHMENPUZZLE „TIERPARK“
FRAME PUZZLE „ZOO“ 27

Puzzlegröße | Puzzle Size:
 405 x 283 x 8 mm
 VE (PU): 12

3+

16210
BODENPUZZLE „WALD ENTDECKEN“
FLOOR PUZZLE „DISCOVER THE FOREST“ 30

Puzzlegröße | Puzzle Size:
 1200 x 145 x 6 mm
 VE (PU): 10

3+

16211
BODENPUZZLE „TIEFSEE BIS WELTALL“
FLOORPUZZLE „DEEP SEA TO COSMOS“ 31

Puzzlegröße | Puzzle Size:
 289 x 630 x 6 mm
 VE (PU): 10

3+

16212
BODENPUZZLE „ENTDECKE DIE
BLUMENWIESE“ | FLOOR PUZZLE
„DISCOVER THE FLOWER MEADOW“ 29

Puzzlegröße | Puzzle Size:
 298 x 630 x 6 mm
 VE (PU): 10

3+

NEW!

17024
LAGEN-PUZZLE „MUTTER“
LAYER-PUZZLE „MOTHER“ 43

Puzzlegröße | Puzzle Size:
 145 x 295 x 20 mm
 VE (PU): 10/20

4+

17035
LAGEN-PUZZLE „FEUERWEHR“
LAYER-PUZZLE „FIRE BRIGADE“ 49

Puzzlegröße | Puzzle Size:
 295 x 207 x 18 mm
 VE (PU): 6/18

4+

17039
LAGEN-PUZZLE „APFEL“
LAYER-PUZZLE „APPLE“ 45

Puzzlegröße | Puzzle Size:
 145 x 145 x 18 mm
 VE (PU): 20/40

4+

17040
LAGEN-PUZZLE „ERDBEERE“
LAYER-PUZZLE „STRAWBERRY“ 45

Puzzlegröße | Puzzle Size:
 145 x 145 x 18 mm
 VE (PU): 20/40

4+

17043
LAGEN-PUZZLE „KARTOFFEL“
LAYER-PUZZLE „POTATO“ 45

Puzzlegröße | Puzzle Size:
 145 x 145 x 18 mm
 VE (PU): 20/40

4+

17044
LAGEN-PUZZLE „KAROTTE“
LAYER-PUZZLE „CARROT“ 44

Puzzlegröße | Puzzle Size:
 145 x 145 x 18 mm
 VE (PU): 20/40

4+

17049
LAGEN-PUZZLE „BANANE“
LAYER-PUZZLE „BANANA“ 45

Puzzlegröße | Puzzle Size:
 145 x 145 x 18 mm
 VE (PU): 20/40

4+

17052
LAGEN-PUZZLE „OMA & OPA“
LAYER-PUZZLE „GRANDMA & GRANDPA“ 43

Puzzlegröße | Puzzle Size:
 295 x 207 x 18 mm
 VE (PU): 6/18

4+

17053
LAGEN-PUZZLE „FROSCH“
LAYER-PUZZLE „FROG“ 46

Puzzlegröße | Puzzle Size:
 205 x 205 x 20 mm
 VE (PU): 6/24

4+

PUZZLES

17054
LAGEN-PUZZLE „SCHMETTERLING“
LAYER-PUZZLE “BUTTERFLY”

Puzzlegröße | Puzzle Size:
205 × 205 × 20 mm
VE (PU): 6/24

46

4+ 28



17055
LAGEN-PUZZLE „ENTE“
LAYER-PUZZLE “DUCK”

Puzzlegröße | Puzzle Size:
205 × 205 × 20 mm
VE (PU): 6/24

46

4+ 28



17058
LAGEN-PUZZLE-SET „ANIKA & DENIS“
LAYER-PUZZLE-SET “ANIKA & DENIS”

Puzzlegröße | Puzzle Size:
140 × 293 × 7 mm
VE (PU): 20

43

3+ 13



17060
LAGEN-PUZZLE „HONIG“
LAYER-PUZZLE “HONEY”

Puzzlegröße | Puzzle Size:
205 × 205 × 20 mm
VE (PU): 6/24

47

4+ 28



17061
LAGEN-PUZZLE „ZUHAUSE“
LAYER-PUZZLE “HOME”

Puzzlegröße | Puzzle Size:
245 × 297 × 20 mm
VE (PU): 12

48

4+ 33



17150
LAGEN-PUZZLE „4 JAHRESZEITEN“
LAGEN-PUZZLE “4 SEASONS”

Puzzlegröße | Puzzle Size:
290 × 140 × 18 mm
VE (PU): 10/20

49

4+ 36



17160
KÖRPER-PUZZLE „MÄDCHEN“
BODY-PUZZLE “GIRL”

Puzzlegröße | Puzzle Size:
145 × 295 × 20 mm
VE (PU): 10/20

42

4+ 29



17170
KÖRPER-PUZZLE „JUNGE“
BODY-PUZZLE “BOY”

Puzzlegröße | Puzzle Size:
145 × 295 × 20 mm
VE (PU): 10/20

42

4+ 29





GAMES



21020
LOGIPIC

94



Boxgröße | Box Size:
320 × 225 × 45 mm
VE (PU): 8



3+

21021
LOGITURN

95



Boxgröße | Box Size:
320 × 225 × 45 mm
VE (PU): 8



4+

21022
MARBELINO 1 - SORTING GAME

72



Boxgröße | Box Size:
315 × 307 × 105 mm
VE (PU): 6



3+

21023
MARBELINO 2 - PATTERN GAME

73



Boxgröße | Box Size:
265 × 257 × 95 mm
VE (PU): 6



4+

21040
MAGNETIC DRAWING BOARD

93



Boxgröße | Box Size:
280 × 255 × 12 mm
VE (PU): 20



3+

21050
MAGNETSPIEL KUNTERBUNT

92



Boxgröße | Box Size:
325 × 325 × 28 mm
VE (PU): 20



3+

21070
LOGIPLAY

94



Boxgröße | Box Size:
320 × 225 × 45 mm
VE (PU): 8



4+

21080
**MAGNETIC DRAWING BOARD
„LETTERS“**

93



Boxgröße | Box Size:
280 × 255 × 12 mm
VE (PU): 20



3+

21090
**MAGNETIC DRAWING BOARD, 12ER SET
SET OF 12 MAGNETIC DRAWING BOARD**

93



Boxgröße | Box Size:
175 × 215 × 12 mm
VE (PU): 2



3+

21120
FLEXIPAINTER

92



Boxgröße | Box Size:
280 × 270 × 30 mm
VE (PU): 9



4+

22355
MECKI & CO.

91



Boxgröße | Box Size:
385 × 385 × 60 mm
VE (PU): 6



4+

22360
FISHING FEVER

88



Boxgröße | Box Size:
400 × 120 × 120 mm
VE (PU): 12



4+

22370
GOLDENER APFEL

91



Boxgröße | Box Size:
385 × 385 × 60 mm
VE (PU): 6



3+

22380
MARTELLO

88



Boxgröße | Box Size:
240 × 240 × 65 mm
VE (PU): 12



4+

22390
BANDITTI

79



Boxgröße | Box Size:
378 × 275 × 65 mm
VE (PU): 12



4+

22396
TASTARO

98



Boxgröße | Box Size:
225 × 225 × 50 mm
VE (PU): 12



4+

22400
MONKEY RALLYE

84



Boxgröße | Box Size:
385 × 385 × 60 mm
VE (PU): 6



4+

22411
FIND MONTY!

90



Boxgröße | Box Size:
240 × 240 × 65 mm
VE (PU): 12



4+

22451
TORRETA

89



Boxgröße | Box Size:
240 × 240 × 65 mm
VE (PU): 12



4+

22461
CANDY

87



Boxgröße | Box Size:
240 × 240 × 65 mm
VE (PU): 12



4+

22463
BETTY FLY

65



Boxgröße | Box Size:
460 × 120 × 120 mm
VE (PU): 10



4+



SPIELE

22471
SHAPY



Boxgröße | Box Size:
240 x 240 x 65 mm
VE (PU): 12



4+

45



22481
RONDO VARIO



Boxgröße | Box Size:
240 x 240 x 65 mm
VE (PU): 12



3+

48



22510
TROPICANO



Boxgröße | Box Size:
385 x 385 x 80 mm
VE (PU): 6



5+

89



22571
LEGOLINO



Boxgröße | Box Size:
240 x 240 x 65 mm
VE (PU): 12



4+

31



22600
LITTLE VILLAGE



Boxgröße | Box Size:
385 x 385 x 60 mm
VE (PU): 6



4+

30



22611
FAIRY LAND



Boxgröße | Box Size:
310 x 310 x 65 mm
VE (PU): 6



4+

59



22612
FUN PARK



Boxgröße | Box Size:
385 x 385 x 60 mm
VE (PU): 6



4+

38



22613
MIA'S GARDEN



Boxgröße | Box Size:
150 x 150 x 60 mm
VE (PU): 20



4+

40



22614
COOKIE DOO



Boxgröße | Box Size:
120 x 120 x 510 mm
VE (PU): 10



3+

34



22615
SPLASH



Boxgröße | Box Size:
225 x 225 x 70 mm
VE (PU): 10



3+

25



22616
MEMONEXT



Boxgröße | Box Size:
250 x 200 x 65 mm
VE (PU): 10



4+

42



22617
DOMINEXT



Boxgröße | Box Size:
250 x 200 x 65 mm
VE (PU): 10



4+

32



22618
JOE' ZOO



Boxgröße | Box Size:
385 x 385 x 60 mm
VE (PU): 6



4+

95



22619
QUAKI



Boxgröße | Box Size:
115 x 175 x 15 mm
VE (PU): 12



3+

46



NEW!

22620
HAPPY & HARMONY



Boxgröße | Box Size:
224x224x9 mm
VE (PU): 10



4+

41



NEW!

22700
HAPPY MAGIC
HAPPY MAGIC



Boxgröße | Box Size:
378 x 275 x 65 mm
VE (PU): 12



4+

31



22701
HEXENKÜCHE
WITCHES' KITCHEN



Boxgröße | Box Size:
378 x 275 x 65 mm
VE (PU): 10



4+

31



22710
HAPPY FARM



Boxgröße | Box Size:
378 x 275 x 50 mm
VE (PU): 12



4+

53



22740
READ MY MIND



Boxgröße | Box Size:
180 x 110 x 35 mm
VE (PU): 12/48



5+

80



22790
TEMPO TONI



Boxgröße | Box Size:
240 x 240 x 65 mm
VE (PU): 12



4+

25



22800
CATCH THE NUMBER



Boxgröße | Box Size:
240 x 240 x 65 mm
VE (PU): 12



5+

51



GAMES



22830
FLOOPING

81



Boxgröße | Box Size:
378 x 275 x 65 mm
VE (PU): 12



4+ 32 !1

22860
PUNAKAI

78



Boxgröße | Box Size:
240 x 240 x 65 mm
VE (PU): 12



4+ 45 !1

22870
ACROBATICO

80



Boxgröße | Box Size:
320 x 225 x 45 mm
VE (PU): 12



4+ 26 !1

22890
FIRE ALARM

76



Boxgröße | Box Size:
378 x 275 x 65 mm
VE (PU): 12



3+ 46 !1

22900
EL GECKO

81



Boxgröße | Box Size:
310 x 220 x 40 mm
VE (PU): 6



4+ 21 !1

23654
OOPS!

98



Boxgröße | Box Size:
515 x 530 x 60 mm
VE (PU): 6



3+ 44 !1

25510
XXL FISHING FEVER

99



Boxgröße | Box Size:
680 x 280 x 190 mm
VE (PU): 2



4+ 21 !1

25512
XXL TORRETA

99



Boxgröße | Box Size:
385 x 325 x 95 mm
VE (PU): 4



4+ 21 !1

25520
XXL HEXENKÜCHE
XXL WITCHES' KITCHEN

99



Boxgröße | Box Size:
650 x 650 x 75 mm
VE (PU): 2



4+ 31 !1

25540
CASSADO

98



Boxgröße | Box Size:
710 x 710 x 30 mm
VE (PU): 1



5+ 56 !1

25550
XXL RONDO VARIO

99



Boxgröße | Box Size:
325 x 285 x 86 mm
VE (PU): 6



3+ 48 !1

25560
XXL CANDY

99



Boxgröße | Box Size:
375 x 235 x 75 mm
VE (PU): 8



4+ 45 !1

25581
WOBBLING CITY

75



Boxgröße | Box Size:
460 x 465 x 100 mm
VE (PU): 4



3+ 36 !1

25582
CLIMB

74



Boxgröße | Box Size:
410 x 400 x 450 mm
VE (PU): 1



4+ 25 !1

25583
XXL PUNAKAI

97



Boxgröße | Box Size:
820 x 125 x 125 mm
VE (PU): 1



4+ 45 !1

NEW!

BAUEN & EXPERIMENTIEREN

 21006
TOPOLOGO „VISIO“

 114



Produktgröße | Product Size:
248 × 248 × 120 mm
VE (PU): 2



 21024
**KLANGKOFFER „LET'S PLAY“
MELODY BOX „LET'S PLAY!“**

 107



Produktgröße | Product Size:
400 × 300 × 60 mm
VE (PU): 4



 23607
**RASSELBANDE
SOUND BOX**

 113



Produktgröße | Product Size:
325 × 250 × 90 mm
VE (PU): 8



 23608
**GEWICHTEBOX
WEIGHT BOX**

 113



Produktgröße | Product Size:
220 × 180 × 70 mm
VE (PU): 8



 23614
**TANDEM-TAFELN
TANDEM BOARDS**

 113



Produktgröße | Product Size:
540 × 360 × 110 mm
VE (PU): 4



 24040
TANGEO

 114



Produktgröße | Product Size:
280 × 275 × 65 mm
VE (PU): 4



 24200
FLEXISTIX XXL KINDERGARTEN-SET

 111



Produktgröße | Product Size:
420 × 290 × 225 mm
VE (PU): 1



 24201
XXL RAILWAY-SET

 109



Produktgröße | Product Size:
470 × 340 × 240 mm
VE (PU): 1

NEW!

 24210
QUADRILLA XXL KINDERGARTEN-SET

 110



Produktgröße | Product Size:
510 × 360 × 260 mm
VE (PU): 1



 24220
**JUNIOR INVENTOR
XXL KINDERGARTEN-SET**

 112



Produktgröße | Product Size:
735 × 505 × 14 mm
VE (PU): 1



 24300
FRÖBEL SET 1

 104



Produktgröße | Product Size:
400 × 300 × 130 mm
VE (PU): 1

NEW!

 24301
FRÖBEL SET 2

 105



Produktgröße | Product Size:
400 × 300 × 130 mm
VE (PU): 1

NEW!

 68500
**FLYING COLOURS
FLYING COLOURS**

 115



Produktgröße | Product Size:
690 × 500 × 130 mm
VE (PU): 1



 68501
**5 × SCHABER + 20 × PLASTIKLEER-
FLASCHEN | SET OF 5 SCRAPERS &
20 BOTTLES**

 115



Produktgröße | Product Size:
150 × 45 × 45 mm (bottle)
VE (PU):

POLY-M



<p>20005 FIRST BLOCKS IN MULTIBOX M</p>  <p>Boxgröße Box Size: 380 x 280 x 190 mm VE (PU): 2</p>  <p>12 M+ 118 !</p>	<p>20010 FIRST BLOCKS CLASS-SET IN MULTIBOX L</p>  <p>Boxgröße Box Size: 380 x 280 x 270 mm VE (PU): 2</p>  <p>12 M+ 218 !</p>	<p>20015 FREISPIELSET FIRST BLOCKS FREE PLAY SET FIRST BLOCKS</p>  <p>VE (PU): 1</p>  <p>12 M+ 500 !</p>
<p>20020 TWINI BIG BLOCKS</p>  <p>Boxgröße Box Size: VE (PU): 1</p>  <p>12 M+ 300 !</p>	<p>20110 STARTER IN MULTIBOX M</p>  <p>Boxgröße Box Size: 380 x 280 x 190 mm VE (PU): 2</p>  <p>12 M+ 450 !</p>	<p>20205 CLASSIC</p>  <p>VE (PU): 4</p>  <p>3+ 480 !</p>
<p>20220 JUMBO</p>  <p>VE (PU): 2</p>  <p>3+ 550 !</p>	<p>20240 GRUPPENSET GROUP SET</p>  <p>VE (PU): 2</p>  <p>3+ 400 !</p>	<p>20305 KREATIVSET CREATIVE SET</p>  <p>VE (PU): 2</p>  <p>3+ 490 !</p>
<p>20500 FREUNDE AUS ALLER WELT FRIENDS FROM ALL OVER THE WORLD</p>  <p>VE (PU): 4</p>  <p>24 M+ 47 !</p>	<p>20505 BAUERNHOFTIERE FARM ANIMALS</p>  <p>VE (PU): 4</p>  <p>3+ 50 !</p>	<p>20700 HAPPY FLOWERS HAPPY FLOWERS</p>  <p>VE (PU): 4</p>  <p>3+ 404 !</p>
<p>20705 MOSAIC IN MULTIBOX S MOSAIC IN MULTIBOX S</p>  <p>Boxgröße Box Size: 380 x 280 x 100 mm VE (PU): 4</p>  <p>3+ 125 !</p>	<p>20800 MEGA-BAUPLATTEN MEGA-CONSTRUCTION PLATES</p>  <p>VE (PU): 5</p>  <p>24 M+ 2 !</p>	<p>20801 GRUNDPLATTEN MIT ANHÄNGEK. BASE PLATES WITH COUPLINGS</p>  <p>VE (PU): 10</p>  <p>24 M+ 4 !</p>
<p>20802 GRUNDPLATTEN BASE PLATES</p>  <p>VE (PU): 10</p>  <p>24 M+ 10 !</p>	<p>20804 RADSÄTZE WHEELSETS</p>  <p>VE (PU): 10</p>  <p>24 M+ 12 !</p>	<p>20900 MULTIBOX S MIT DECKEL ROT MULTIBOX S WITH LID RED</p>  <p>Boxgröße Box Size: 380 x 280 x 100 mm VE (PU): 4</p>  <p>2</p>
<p>20901 MULTIBOX S MIT DECKEL BLAU MULTIBOX S WITH LID BLUE</p>  <p>Boxgröße Box Size: 380 x 280 x 100 mm VE (PU): 4</p>  <p>2</p>	<p>20904 MULTIBOX M MIT DECKEL BLAU MULTIBOX M WITH LID BLUE</p>  <p>Boxgröße Box Size: 380 x 280 x 190 mm VE (PU): 6</p>  <p>2</p>	<p>20906 MULTIBOX L MIT DECKEL ROT MULTIBOX L WITH LID RED</p>  <p>Boxgröße Box Size: 380 x 280 x 270 mm VE (PU): 5</p>  <p>2</p>



POLY-M

20907
MULTIBOX L MIT DECKEL BLAU
MULTIBOX L WITH LID BLUE



20908
MULTIBOX L MIT DECKEL GRÜN
MULTIBOX L WITH LID GREEN



Boxgröße | Box Size:
380 x 280 x 270 mm
VE (PU): 5



Boxgröße | Box Size:
380 x 280 x 270 mm
VE (PU): 5



WAND- & RAUM ELEMENTE

23610
WANDELEMENT „LABYRINTH“
WALL ELEMENT "LABYRINTH"



23612
WANDELEMENT „STECKFORMEN“
WALL ELEMENT "SHAPES"



23621
WANDELEMENT „SCHMETTERLING“
WALL ELEMENT "BUTTERFLY"



Produktgröße | Product Size:
400 x 400 x 30 mm
VE (PU): 6



Produktgröße | Product Size:
400 x 400 x 30 mm
VE (PU): 6



Produktgröße | Product Size:
600 x 500 x 30 mm
VE (PU): 4



23622
WANDELEMENT „WELLE“
WALL ELEMENT "WAVE"



23623
WANDELEMENT „BERGE“
WALL ELEMENT "MOUNTAINS"



23630
WANDELEMENT RAUPE „KOPF“
WALL ELEMENT CATERPILLAR "HEAD"



Produktgröße | Product Size:
600 x 500 x 30 mm
VE (PU): 4



Produktgröße | Product Size:
600 x 500 x 30 mm
VE (PU): 4



Produktgröße | Product Size:
540 x 480 mm
VE (PU): 1



23631
**WANDELEMENT RAUPE „DREH-
LABYRINTH“ | WALL ELEMENT CATER-
PILLAR "TURNING AROUND LABYRINTH"**



23632
WANDELEMENT RAUPE „WAAGE“
WALL ELEMENT CATERPILLAR
"BALANCE"



23633
WANDELEMENT RAUPE „KREISEL“
WALL ELEMENT CATERPILLAR
"PEGTOP"



Produktgröße | Product Size:
450 x 480 mm
VE (PU): 2



Produktgröße | Product Size:
450 x 480 mm
VE (PU): 2



Produktgröße | Product Size:
450 x 480 mm
VE (PU): 2



23634
WANDELEMENT RAUPE „UHR“
WALL ELEMENT CATERPILLAR "CLOCK"



68000
ANZIEHHILFE
SMART BENCH



68010
SCHUHAUSZIEHER
BOOT TAKER



Produktgröße | Product Size:
450 x 480 mm
VE (PU): 2



Produktgröße | Product Size:
830 x 600 x 780 mm
VE (PU): 1



Produktgröße | Product Size:
400 x 390 x 600 mm
VE (PU): 1



68030
STIEFELWAGEN
BOOT HANGER



68120
TROCKENWAGEN
DRYING SHELF



Produktgröße | Product Size:
1110 x 400 x 980 mm
VE (PU): 1



Produktgröße | Product Size:
460 x 330 x 980 mm
VE (PU): 1



ROLEPLAY



24230
XXL CITY-PARKHAUS
XXL CITY-PARKHOUSE

133

24231
XL AKTIONS-THEATER
XL ACTION THEATER

144

24232
DOCTOR STATION 3 IN 1
DOCTOR STATION 3 IN 1

137



Produktgröße | Product Size:
915 x 700 x 600 mm
VE (PU): 1



3+



Produktgröße | Product Size:
750 x 1200 x 410 mm
VE (PU): 1



3+



Produktgröße | Product Size:
1100 x 1120 x 400 mm
VE (PU): 1



4+

24233
DOKTOR-SET
DOCTOR ON CALL

138

24235
PUPPENHAUS,
XXL KINDERGARTEN SET, 43 TLG.

131

24236
MOBILES HAUSHALTS-CENTER 4 IN 1
MOBILE HOUSEKEEPING CENTER 4 IN 1

135



Produktgröße | Product Size:
200 x 80 x 150 mm
VE (PU): 12



3+



VE (PU): 1



3+

NEW!



VE (PU): 1



4+

NEW!

24237
KOCHGRUNDLAGEN + GEMÜSE, XL SET
COOKING ESSENTIALS + VEGETABLES,
XL SET

138

24401
BUGGY

147

40030
HANDPUPPE „MAUS“
HANDPUPPET "MOUSE"

141



VE (PU): 8



3+

NEW!



Produktgröße | Product Size:
420 x 360 x 600 mm
VE (PU): 2



24
M+



VE (PU): 4/96



3+

40032
HANDPUPPE „RAUPE“
HANDPUPPET "CATERPILLAR"

140

40034
HANDPUPPE „MARIENKÄFER“
HANDPUPPET "LADYBIRD"

140

40036
HANDPUPPE „BIENE“
HANDPUPPET "BEE"

140



VE (PU): 4/96



3+



VE (PU): 4/96



3+



VE (PU): 4/96



3+

40038
HANDPUPPE „PANDA“
HANDPUPPET "PANDA"

141

40105
HANDPUPPE „T-REX“
HANDPUPPET "T-REX"

142

40110
HANDPUPPE „SCHILDKRÖTE“
HANDPUPPET "TURTLE"

141



VE (PU): 4/96



3+



VE (PU): 4/96



3+



VE (PU): 4/96



3+

40111
HANDPUPPE „KUH“
HANDPUPPET "COW"

141

40112
HANDPUPPE „HUHN“
HANDPUPPET "CHICKEN"

141

40113
HANDPUPPE „SCHWEIN“
HANDPUPPET "PIG"

141



VE (PU): 4/96



3+



VE (PU): 4/96



3+



VE (PU): 4/96



3+

40114
HANDPUPPE „FUCHS“
HANDPUPPET "FOX"

142

40115
HANDPUPPE „ENTE“
HANDPUPPET "DUCK"

141

40116
HANDPUPPE „HUND“
HANDPUPPET "DOG"

141



VE (PU): 4/96



3+



VE (PU): 4/96



3+



VE (PU): 4/96



3+



ROLLENSPIEL

40117
HANDPUPPE „TIGER“
HANDPUPPET „TIGER“



40118
HANDPUPPE „EULE“
HANDPUPPET „OWL“



40119
HANDPUPPE „GIRAFFE“
HANDPUPPET „GIRAFFE“



VE (PU): 4/96



3+



VE (PU): 4/96



3+



VE (PU): 4/96



3+

40120
HANDPUPPE „SCHAF“
HANDPUPPET „SHEEP“



40121
HANDPUPPE „PFERD“
HANDPUPPET „HORSE“



40122
HANDPUPPE „KATZE“
HANDPUPPET „CAT“



VE (PU): 4/96



3+



VE (PU): 4/96



3+



VE (PU): 4/96



3+

40123
HANDPUPPE „AFFE“
HANDPUPPET „MONKEY“



40124
HANDPUPPE „HASE“
HANDPUPPET „RABBIT“



40125
HANDPUPPE „BÄR“
HANDPUPPET „BEAR“



VE (PU): 4/96



3+



VE (PU): 4/96



3+



VE (PU): 4/96



3+

40126
HANDPUPPE „HAHN“
HANDPUPPET „ROOSTER“



40129
HANDPUPPE „KROKODIL“
HANDPUPPET „CROCODILE“



40127
HANDPUPPE „LÖWE“
HANDPUPPET „LION“



VE (PU): 4/96



3+



VE (PU): 4/96



3+



VE (PU): 4/96



3+

40128
HANDPUPPE „ELEFANT“
HANDPUPPET „ELEPHANT“



40130
HANDPUPPE „EICHHÖRNCHEN“
HANDPUPPET „SQUIRREL“



40131
HANDPUPPE „PAPAGEI“
HANDPUPPET „PARROT“



VE (PU): 4/96



3+



VE (PU): 4/96



3+



VE (PU): 4/96



3+

40250
HANDPUPPE „IGEL“
HANDPUPPET „HEDGEHOG“



40255
HANDPUPPE „SPINNE“
HANDPUPPET „SPIDER“



40275
HANDPUPPE „KÄNGURU“
HANDPUPPET „KANGAROO“



VE (PU): 4/96



3+



VE (PU): 4/96



3+



VE (PU): 4/96



3+

40277
HANDPUPPE „FROSCH“
HANDPUPPET „FROG“



40280
HANDPUPPE „SCHMETTERLING“
HANDPUPPET „BUTTERFLY“



40318
„PUPPETSHOW“



VE (PU): 4/96



3+



Produktgröße | Product Size:

VE (PU): 4/96



3+



Produktgröße | Product Size:
8-teilig | set of 8 puppets
VE (PU): 5



3+

ROLEPLAY



40411
MILA MOUSE AND FRIENDS



40421
MIKE MOLE AND FRIENDS



40431
OTIS OWL AND FRIENDS



Produktgröße | Product Size:
Ø 260 × 350 mm
VE (PU): 24

3+



Produktgröße | Product Size:
Ø 250 × 350 mm
VE (PU): 24

3+



Produktgröße | Product Size:
Ø 160 × 230 mm
VE (PU): 24



3+

40440
CHEETA & BIBI



40450
KANGA & JUJU



40460
CARA & MIMI



Produktgröße | Product Size:
300 mm
VE (PU): 4/48



3+



Produktgröße | Product Size:
300 mm
VE (PU): 4/48



3+



Produktgröße | Product Size:
300 mm
VE (PU): 4/48



3+

42045
OSCAR



42060
MARIONETTE TUKAN „TONI“
STRING PUPPET TUKAN „TONI“



Produktgröße | Product Size:
Ø 665 _ 310 mm
VE (PU): 1



24
M+



Produktgröße | Product Size:
1000 mm × 1000mm
VE (PU): 10



3+





SAND & BEWEGUNG

40721
MASSAGEBÄLLE, 25ER SET
SET OF 25 MASSAGE BALLS

152

53120
AUFBLASBARER „SUPER-SOFTBALL“
INFLATING "SUPER SOFT BALL"

152

66000
GROSSER TRUCK
GIANT TRUCK

156

Produktgröße | Product Size:
Ø 100 mm
VE (PU): 6 Set



3+



Produktgröße | Product Size:
Ø 230 mm
VE (PU): 12/144



3+



Produktgröße | Product Size:
620 x 390 x 360 mm
VE (PU): 2



24
M+

66010
DUMPER

157

66020
TRAKTOR MIT ANHÄNGER
TRACTOR WITH TRAILER

163

66030
KIPPLASTER
TRUCK

160

Produktgröße | Product Size:
650 x 415 x 400 mm
VE (PU): 1



18
M+



Produktgröße | Product Size:
550 x 160 x 155 mm
VE (PU): 4



18
M+



Produktgröße | Product Size:
310 x 210 x 195 mm
VE (PU): 8



18
M+

66040
SANDSCHAUFEL
SAND SHOVEL

162

66050
STRUKTURROLLER, 5ER SET
SET OF 5 TRACK ROLLERS

163

66060
MULTISCHAUFEL
MULTI SHOVEL

161

Produktgröße | Product Size:
240 x 80 x 80 mm
VE (PU): 48



18
M+



Produktgröße | Product Size:
je/each 145 x 180 x 80 mm
VE (PU): 8 Set



18
M+



Produktgröße | Product Size:
150 x 80 x 715 mm
VE (PU): 12



18
M+



SAND & MOVEMENT



66070
EIMER
BUCKET



Produktgröße | Product Size:
Ø 160 x 140 mm
VE (PU): 24



18
M+

162

66080
RADLADER
LOADER



Produktgröße | Product Size:
420 x 180 x 280 mm
VE (PU): 8



18
M+

160

66090
EIMER, TRANSPARENT
BUCKET, TRANSPARENT



Produktgröße | Product Size:
Ø 160 x 165 mm
VE (PU): 24



18
M+

162

66100
SANDBAGGER
DOZER



Produktgröße | Product Size:
370 x 255 x 195 mm
VE (PU): 8



18
M+

160

66110
SANDWALZE
ROLLER



Produktgröße | Product Size:
350 x 255 x 185 mm
VE (PU): 8



18
M+

160

67050
BÄLLE, 4ER SET
SET OF 4 BALLS



Produktgröße | Product Size:
Ø 250 mm, Ø 210 mm, Ø 170 mm,
Ø 120 mm
VE (PU): 5/10



3+

152

67061
MULTI MOVES
MULTI MOVES



Produktgröße | Product Size:
Ø 95 mm
VE (PU): 3



3+

152

67080
NET BALL



Produktgröße | Product Size:
310 x 340 x 40 mm
VE (PU): 12



4+

150

67110
JUMP & THROW



Produktgröße | Product Size:
330 x 350 x 100 mm
VE (PU): 6/12



4+

150

67140
STEPPING STONES, SET



Produktgröße | Product Size:
Ø 340 mm
VE (PU): 2



3+

155

67150
BALANCIERKISSEN
SEAT CUSHION



Produktgröße | Product Size:
Ø 340 mm
VE (PU): 6



3+

155

67200
MAGIC DRIVING CAR



Produktgröße | Product Size:
690 x 280 x 370 mm
VE (PU): 1



3+

153

67130
BALANCE BOARD



Produktgröße | Product Size:
500 x 375 x 60 mm
VE (PU): 2



4+

151

92258
SAND SET „STABIL“
SAND SET „STABLE“



Produktgröße | Product Size:
560 x 300 x 305 mm
VE (PU): 1

24
M+

158

92259
SAND SET „SPEZIAL“
SAND SET „SPECIAL“



Produktgröße | Product Size:
500 x 360 x 335 mm
VE (PU): 1

24
M+

158

92280
SAND SET „FORMEN & BAUEN“
SAND SET „FORMING & BUILDING“

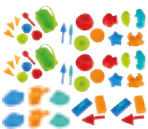

Produktgröße | Product Size:
300 x 200 x 405 mm
VE (PU): 1

24
M+

158

92303
SAND SET „GLÜCKLICHE BAUMEISTER“
SAND SET „HAPPY BUILDERS“

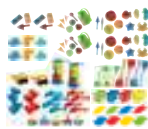

Produktgröße | Product Size:
besteht aus drei Kartons:
VE (PU): 1

24
M+

159



TOPTRIKE

60200
**ROLLERSTAND
SCOOTER STAND**

Produktgröße | Product Size:
1200 x 210 x 130 mm
VE (PU): 1



191

60201
**WANDAUFHÄNGER
SCOOTER HANGER**

Produktgröße | Product Size:
180 x 230 x 230 mm
VE (PU): 4



191

62060
**MOBILE TANK- UND SERVICESTATION
MOBILE GAS- AND SERVICESTATION**

Produktgröße | Product Size:
850 x 340 mm
VE (PU): 1



3+

190

64000
**ROLLER „BENGY“
SCOOTER „BENGY“**

Produktgröße | Product Size:
760 x 410 x 500 mm
VE (PU): 1



3+

185

64010
**ROLLER, GROSS
SCOOTER, BIG**

Produktgröße | Product Size:
1070 x 480 x 820 mm
VE (PU): 1



5+

185

64020
**ROLLER, KLEIN
SCOOTER, SMALL**

Produktgröße | Product Size:
1070 x 470 x 720 mm
VE (PU): 1



3+

184

64030
**LAUFRAD „LITTLE WALKER“
LITTLE WALKER**

Produktgröße | Product Size:
760 x 410 x 500 mm
VE (PU): 1



24
M+

175

64040
**LAUFRAD „WALKER“
WALKER**

Produktgröße | Product Size:
890 x 460 x 620 mm
VE (PU): 1



3+

189

64050
**KLEINES DREIRAD
SMALL TRIKE**

Produktgröße | Product Size:
750 x 440 x 520 mm
VE (PU): 1



24
M+

174

64060
**DREIRAD „ROOKIE“
ROOKIE**

Produktgröße | Product Size:
930 x 550 x 640 mm
VE (PU): 1



4+

179

64070
**DREIRAD „TAXI“
TAXI**

Produktgröße | Product Size:
1120 x 560 x 640 mm
VE (PU): 1



3+

188

64080
**DREIRAD „EXPRESS“
EXPRESS TRIKE**

Produktgröße | Product Size:
1180 x 650 x 640 mm
VE (PU): 1



4+

188

64100
**LAUFRAD „QUADDY“
QUADDY**

Produktgröße | Product Size:
530 x 320 x 350 mm
VE (PU): 1



18
M+

173

64116
**WHEELIE, 4ER SET
WHEELIE, SET OF 4**

Produktgröße | Product Size:
780 x 220 x 220 mm
VE (PU): 1



24
M+

NEW!

176

64120
**DREIRAD „RIDER“
RIDER**

Produktgröße | Product Size:
930 x 620 x 340 mm
VE (PU): 1



5+

179

64130
CHOPPER

Produktgröße | Product Size:
960 x 590 x 660 mm
VE (PU): 1



4+

179

64140
**DREIRAD „DOPPELTAXI“
PILLION TAXI**

Produktgröße | Product Size:
1130 x 680 x 640 mm
VE (PU): 1



4+

182

64170
**DREIRAD „SEITENWAGEN“
SIDE CAR**

Produktgröße | Product Size:
910 x 800 x 640 mm
VE (PU): 1



4+

182

64180
**RIKSCHA
RICKSHAW**

Produktgröße | Product Size:
1220 x 650 x 500 mm
VE (PU): 1



3+

189

64190
**KRIPPENROLLER
MINI ROLLY**

Produktgröße | Product Size:
680 x 265 x 580 mm
VE (PU): 1



24
M+

175

64200
LERNFABRRAD „TOP BIKE“

Produktgröße | Product Size:
930 x 460 x 640 mm
VE (PU): 1



4+

188

TOPTRIKE



64240
LAUFRAD „LITTLE DRIFTER“

173

64270
SPEED STAR SMALL

183

64280
SPEED STAR BIG

183



Produktgröße | Product Size:
800 × 410 × 500 mm
VE (PU): 1



24
M+



Produktgröße | Product Size:
750 × 460 × 280 mm
VE (PU): 1



4-6



Produktgröße | Product Size:
850 × 460 × 280 mm
VE (PU): 1



7-10

64290
DRIFT RIDER

178

64300
LITTLE DRIVER

170

64310
LITTLE CRUISER

170



Produktgröße | Product Size:
1150 × 560 × 700 mm
VE (PU): 1



5+



Produktgröße | Product Size:
540 × 240 × 370 mm
VE (PU): 1



12
M+



Produktgröße | Product Size:
640 × 245 × 510 mm
VE (PU): 1



18
M+

64320
LITTLE BALANCER

171

64330
STEP 'N ROLL, KLEIN

181

64340
STEP 'N ROLL, GROSS

181



Produktgröße | Product Size:
730 × 290 × 495 mm
VE (PU): 1



24
M+



Produktgröße | Product Size:
530 × 480 × 740 mm
VE (PU): 1



4+



Produktgröße | Product Size:
530 × 480 × 820 mm
VE (PU): 1



6+

64350
BUGGY

174

64380
QUAD

177

64390
ROLLER „MAXI“
SCOOTER „MAXI“

187



Produktgröße | Product Size:
600 × 630 × 475 mm
VE (PU): 1



3+



Produktgröße | Product Size:
530 × 320 × 350 mm
VE (PU): 1



4+



Produktgröße | Product Size:
860 × 480 × 220 mm
VE (PU): 1



7+

NEW!

68170
FAHRSPUREN, 3ER SET
SET OF 3 ROAD DIRECTIONS

191

68190
WARNWESTE
WARNING VEST

191



Produktgröße | Product Size:
je/each 580 × 900 mm
VE (PU): 10



3+



Produktgröße | Product Size:
450 × 540 mm
VE (PU): 100



3-6

TOPPLAY

24234
XL KÜCHEN-SET
XL KITCHEN SET

Produktgröße | Product Size:
345 × 240 × 118 mm
VE (PU): 8



3+

202

62010
MOBILES GEWÄCHSHAUS
MOBILE GREENHOUSE

Produktgröße | Product Size:
1090 × 600 × 1150 mm
VE (PU): 1



3+

209

62020
MOBILER WASSER-TISCH
MOBILE WATER-TABLE

Produktgröße | Product Size:
800 × 575 × 1000 mm
VE (PU): 1
(2 Pakete | 2 packages)



3+

207

62030
MOBILE MATSCH-KÜCHE
MOBILE MUD KITCHEN

Produktgröße | Product Size:
1060 × 600 × 1080 mm
VE (PU): 1



3+

205

62040
KIOSK 4 IN 1

Produktgröße | Product Size:
1130 × 1130 × 1950 mm
VE (PU): 1
(3 Pakete | 3 packages)



3+

197

62050
CAMPING CAR

Produktgröße | Product Size:
2350 × 630 × 1050 mm
VE (PU): 1
(3 Pakete | 3 packages)



3+

NEW!

199

62060
MOBILE TANK- UND SERVICESTATION
MOBILE GAS- AND SERVICESTATION

Produktgröße | Product Size:
806 × 640 × 840 mm
VE (PU): 1



3+

201

64090
SCHUBKARRE
WHEELBARROW

Produktgröße | Product Size:
885 × 405 × 430 mm
VE (PU): 1



4+

215

64160
BAGGER
DIGGER

Produktgröße | Product Size:
Ø 600 × 900 mm
VE (PU): 1



3+

215

64350
TOPPLAY BUGGY

Produktgröße | Product Size:
600 × 630 × 475 mm
VE (PU): 1



3+

210

64360
KARUSSELL
CAROUSEL

Produktgröße | Product Size:
Ø 850 × 360 mm
VE (PU): 1
(2 Pakete | 2 packages)



3+

211

64370
TOPPLAY WAAGE
TOPPLAY SCALE

Produktgröße | Product Size:
706 × 533 × 920 mm
VE (PU): 1



3+

203

67000
BALANCIERSCHEIBE
TURNING TABLE

Produktgröße | Product Size:
Ø 750 × 270 mm
VE (PU): 1



3+

213

67120
TURN & SWING

Produktgröße | Product Size:
460 × 25000 × 95 mm
VE (PU): 10



3+

213

68042
TRANSPORTWAGEN
TRANSPORT CAGE

Produktgröße | Product Size:
1120 × 706 × 830 mm
VE (PU): 1



3+

214

68230
MULTI-BÄNKE, 4ER SET
MULTI BENCHES, SET OF 4

Produktgröße | Product Size:
1100 × 365 × 330 mm
VE (PU): 1



3+

212

CREATIVE WORLDS & LITTLE GIFTS



40152
TEXTILSTIFTE, 10ER SET
SET OF 10 TEXTILE MARKERS

Produktgröße | Product Size:
 Ø 16 x 110 mm
 VE (PU): 10/40

219

3+ !1

40742
TEELICHTHALTER „STERN“
TEALIGHT HOLDER "STAR"

Produktgröße | Product Size:
 Ø 135 x 10 mm
 VE (PU): 24/288

224

50200
LICHTERHAUS
HOUSE OF LIGHTS

Produktgröße | Product Size:
 110 x 100 x 145 mm
 VE (PU): 12/144

224

50230
TEELICHTHALTER „STERNSCHNUPPE“
TEALIGHT HOLDER "SHOOTING STAR"

Produktgröße | Product Size:
 200 x 100 x 8 mm
 VE (PU): 12/144

224

50250
LATERNE
LANTERN

Produktgröße | Product Size:
 120 x 120 x 140 mm
 VE (PU): 24/288

222

50310
FOTOAUFSTELLER „WINTER“
PHOTO FRAME "WINTER"

Produktgröße | Product Size:
 120 x 40 x 155 mm
 VE (PU): 12/144

222

50340
ANHÄNGER „STERNE“, 3ER SET
SET OF 3 STAR PENDANTS

Produktgröße | Product Size:
 60x100 mm
 VE (PU): 24/288

222

50430
GUMMITWIST „KÄNGURU“
TWISTY "KANGAROO"

Produktgröße | Product Size:
 80 x 100 mm
 VE (PU): 24/144

229

3+ !2

50530
WINTERWUNDERLAND
CHRISTMAS LANDSCAPE

Produktgröße | Product Size:
 160 x 125 x 9 mm
 VE (PU): 12/144

223

50540
ADVENTSKERZENHALTER
TEALIGHT HOLDER

Produktgröße | Product Size:
 220 x 65 x 10 mm
 VE (PU): 12/144

223

52010
MULTIPENS, 10ER SET
SET OF 10 MULTIPENS

Produktgröße | Product Size:
 Ø 16 x 130 mm
 VE (PU): 10/40

219

3+ !1

52020
REGENBOGENSTIFTE, 24ER SET
SET OF 24 RAINBOW PENCILS

Produktgröße | Product Size:
 Ø 10 x 175 mm
 VE (PU): 10/50

219

3+

52030
GELSTICK, 12ER SET
SET OF 12 GELSTICKS

Produktgröße | Product Size:
 Ø 30 x 121 mm
 VE (PU): 8

219

3+ !1

52040
SMOOTH PAINTER, 72ER SET
SET OF 72 SMOOTH PAINTER

Produktgröße | Product Size:
 Ø 20 x 92 mm
 VE (PU): 2

218

3+ !1

52050
SMOOTH METALLIC PAINTER, 12ER SET
SET OF 12 SMOOTH METALLIC PAINTER

Produktgröße | Product Size:
 Ø 20 x 92 mm
 VE (PU): 4/12

218

3+ !1

52060
SMOOTH TEXTILE PAINTER, 12ER SET
SET OF 12 SMOOTH TEXTILE PAINTER

Produktgröße | Product Size:
 Ø 20 x 92 mm
 VE (PU): 4/12

218

3+ !1

53050
KRATZBILDER, CREATING ARTS
SCRATCH PICTURES, CREATING ARTS

Produktgröße | Product Size:
 92,5 x 92,5 x 74 mm
 VE (PU): 6/24

227

4+ !1

53051
DIY KRATZ-POSTER
DIY SCRATCH POSTER

Produktgröße | Product Size:
 750 mm x 520 mm
 VE (PU): 12

226

4+ !1

53080
RAINBOW ART - KRATZBLOCK
RAINBOW ART - SCRATCH BOOK

Produktgröße | Product Size:
 DIN A 5
 VE (PU): 12/240

227

4+ !1

53120
AUFBLASBARER „SUPER-SOFTBALL“
INFLATING "SUPER SOFT BALL"

Produktgröße | Product Size:
 Ø 230 mm
 VE (PU): 12/144

229

3+ !1

53140
TASCHENMONSTER „WARM UND KALT“
POCKET MONSTERS "WARM AND COLD"

Produktgröße | Product Size:
 95 x 120 x 15 mm
 VE (PU): 12/96

228

3+ !1

KREATIV & GESCHENKE

53180
TASCHENLAMPE „ENTDECKER
LED-LICHT“ | FLASHLIGHT „LED LIGHT“

Produktgröße | Product Size:
Ø 32 x 97 mm
VE (PU): 12/144

229

3+ !1



53181
SPRINGMONSTER, 6ER SET
JUMPING MONSTERS

Produktgröße | Product Size:
60 mm
VE (PU): 12/144

228

5+ !1



53183
WINDSPIEL „SCHMETTERLING“
WIND TWISTER „BUTTERFLY“

Produktgröße | Product Size:
1200 x 200 mm
VE (PU): 12/144

225

3+



53185
LED STIRNLAMPE, 3 VERSCH.
FARBEN, MIXED | LED HEADLIGHT,
3 COLORS, MIXED PACKED

Produktgröße | Product Size:
42 x 65 x 30 mm
VE (PU): 12/144

227

3+ !1



53187
MAGNETISCHE LESEZEICHEN,
2 MOTIVE MIXED | MAGNETIC
BOOKMARK, 2 STYLES MIXED PACKED

Produktgröße | Product Size:
30 x 100 mm
VE (PU): 12/576

228

3+ !1



68050
MALSCHÜRZE, 550 MM
PAINT APRON, 550 MM

Produktgröße | Product Size:
1000 x 550 mm
VE (PU): 100

225

3-5



68060
MALSCHÜRZE, 650 MM
PAINT APRON, 650 MM

Produktgröße | Product Size:
1250 x 650 mm
VE (PU): 100

225

6-8



68120
TROCKENWAGEN
DRYING SHELF

Produktgröße | Product Size:
460 x 330 x 980 mm
VE (PU): 1

221



68500
FLYING COLOURS
FLYING COLOURS

Produktgröße | Product Size:
690 x 500 x 130 mm
VE (PU): 1

220

4+



68501
5 x SCHABER + 20 x PLASTIKLEER-
FLASCHEN | SET OF 5 SCRAPERS &
20 BOTTLES

Produktgröße | Product Size:
150 x 45 x 45 mm (bottle)
VE (PU): 18

220

4+ 25 !1



68502
200 STK. BLATT PAPIER FÜR
FARBSCHLEUDER - 150G/M²
200PCS OF PAPER (150G/M²)

Produktgröße | Product Size:
Ø 350 mm
VE (PU): 2

221

4+ 200 !1



68505
TRANSPARENTE FOLIE,
FLYING COLOURS, 50 STÜCK
TRANSPARENT FOIL, 50 PCS

Produktgröße | Product Size:
Ø 350 mm
VE (PU): 2

221

3+ 60 !1



PROMOTION

70007
HOLZ-DISPLAY FÜR 35 HANDPUPPEN
WOODEN DISPLAY FOR 35 HANDPUPPETS

Größe | Size:
Ø 500 mm x 2090 mm
VE (PU): 1

139

4+ 200 !1



SPARE PARTS



22018
MAGNETSTIFT, BLAU
MAGNET PENCIL, BLUE



22023
MAGNETSTIFT SCHWARZ
MAGNET PENCIL, BLACK



66090
EIMER
BUCKET



60500
EVA-HINTERRAD, ROLLER „BENGY“
EVA BACK WHEEL, SCOOTER “BENGY”



60501
EVA-RAD, VORN/HINTEN INKL. HALTERUNG
EVA WHEEL, FRONT/BACK INCL. MOUNTING



60502
EVA-HINTERRAD, DREIRÄDER
EVA BACK WHEEL, TRIKES



60503
EVA-RAD VORN/HINTEN FÜR VERSCH. TYPEN,
INKL. HALTERUNG | EVA WHEEL FRONT/BACK FOR
DIFF. TYPES, INCL. MOUNTING



60505
EVA-RAD, HINTERRAD LAUFRAD „WALKER“ /
SCHUBKARRE | EVA WHEEL, BACK WHEEL WALKER
/ WHEELBARROW



60506
EVA-VORDERRAD, KLEINES DREIRAD
EVA FRONT WHEEL, SMALL TRIKE



60507
EVA-VORDERRAD, DREIRÄDER
EVA FRONT WHEEL, TRIKES



60508
GRIFF GELB/SCHWARZ
HANDLE, YELLOW/BLACK



60509
PEDAL, GELB/SCHWARZ
PEDAL, YELLOW/BLACK



60510
KLEINER SITZ, SCHWARZ
SMALL SEAT, BLACK



60511
LANGER SITZ, SCHWARZ
LONG SEAT, BLACK



60522
WANNE DUMPER
DUMPER BUCKET



60523
KABINE DUMPER
DRIVING ROOM DUMPER



60524
RADKAPPE DUMPER
WHEEL MAT DUMPER



60525
ACHSBUCHSE
AXLE COVER



60526
RAD & RADABDECKUNG
WHEEL & WHEEL COVER



60527
ACHSE
AXLE



60528
ACHSKAPPE
SNAP





ERSATZTEILE

60529
DICHTUNG
WASHER



60530
SCHRAUBEN
SCREWS



60532
WANNE ROT, SCHUBKARRE
TUB RED, WHEELBARROW



60533
LENKRAD, RUTSCHRAD „QUADDY“
STEERING WHEEL, QUADDY



60534
TPR-VORDERRAD, RUTSCHRAD „QUADDY“
TPR FRONT WHEEL, QUADDY



60535
TPR-HINTERRAD, RUTSCHRAD „QUADDY“
TPR BACK WHEEL, QUADDY



60537
ECO-GRIFF FÜR KRIPPENROLLER, SCHWARZ
ECO-HANDLE FOR MINI ROLLY, BLACK



60538
EVA-VORDERRAD, KRIPPENROLLER
EVA FRONT WHEEL, MINI ROLLY



60539
EVA-HINTERRAD, KRIPPENROLLER
EVA BACK WHEEL, MINI ROLLY



60540
TRITTBRETT, KRIPPENROLLER
STEPPING BOARD, MINI ROLLY



60542
TRITTBRETT, ROLLER
STEPPING BOARD, SCOOTER



60543
TRITTBRETT, ROLLER „BENGY“
STEPPING BOARD, SCOOTER "BENGY"



60544
EVA-HINTERRAD, LERNAHRRAD „TOP BIKE“
EVA BACK WHEEL, TOP BIKE



60547
TRITTBRETT, DREIRAD „EXPRESS“
STEPPING BOARD, EXPRESS TRIKE



60548
TRITTBRETT, DREIRAD „TAXI“
STEPPING BOARD, TAXI



60549
SITZBRETT, DREIRAD „DOPPELTAXI“
SEATING BOARD, PILLION TAXI



60550
TRITTBRETT, DREIRAD „DOPPELTAXI“
STEPPING BOARD, PILLION TAXI



60552
TRITTBRETT, DREIRAD „SEITENWAGEN“
STEPPING BOARD, SIDE CAR



60554
EVA-HINTERRAD, DREIRAD „RIDER“
EVA BACK WHEEL, RIDER



60556
TRITTBRETT, BALANCIERSCHEIBE
STEPPING BOARD, TURNING TABLE



60559
SITZBRETT, RIKSCHA
SEATING BOARD, RICKSHAW



SPARE PARTS



60560
TRITTBRETT, RIKSCHA
STEPPING BOARD, RICKSHAW



60569
ACHSKAPPE
RED CAP



60570
PUFFER, 4ER SET
SET OF 4 NYLON BUSH



60571
ERSATZRAD
WHEEL



60573
LENKHALTERUNG MIT ANSCHLAG, 1 PAAR
PAIR STEERING BEARING



60578
KLEINES RAD RIKSCHA
SMALL WHEEL FOR RICKSHAW



60579
GELBE STANGE INKL. KAPPEN
YELLOW BEARS INCL. CAPS



60580
ERSATZTEILSET 1
SPARE PART SET 1



60581
ERSATZTEILSET 2
SPARE PART SET 2



60582
ERSATZTEILSET 3
SPARE PART SET 3



60583
ERSATZTEILSET 4
SPARE PART SET 4



60584
ERSATZTEILSET 5
SPARE PART SET 5



60586
VERBINDUNGSBOLZEN, KURZ
BOLT, SMALL



60587
VERBINDUNGSBOLZEN, LANG
BOLT, LARGE



60589
SCHRAUBENSET
SET OF SCREWS



60590
MUSTERSET „TOPTRIKE“
SAMPLE SET "TOPTRIKE"



60591
RAD „SPEED STAR“
WHEEL "SPEED STAR"



60596
HINTERRAD „DRIFT RIDER“
BACK WHEEL "DRIFT RIDER"



60599
RAD EINZEL
WHEEL



60600
SITZ
SEAT



60601
PEDALE
PEDALS





ERSATZTEILE

60602
RAD HINTEN
REAR WHEEL



60603
RAD
WHEEL



60604
RAD MIT PEDALE
WHEEL WITH PEDALS



60605
RADKAPPEN, ORANGE
HUB CAPS, ORANGE



60606
LENKRAD
STEERING WHEEL



60607
KAPPEN
LOCATION CAPS



60608
SCHRAUBEN
SCREWS



60609
MUTTERN FÜR SITZ
NUTS FOR SEAT



60610
BREMSE
BREAK



60612
KAPPEN, UNTEN
LOCATION CAPS, BELOW



60613
TRITTBRETT
FOOTBOARD



60617
VORDERRAD
FRONT WHEEL



60618
HINTERRAD, RECHTS
BACK WHEEL, RIGHT



60620
HINTERRAD
REAR WHEEL



60621
STOFF
FABRIC



60622
TRITTBRETT
RUNNING BOARD



60623
RAD
WHEEL



60624
SCHRAUBEN-SET
SET OF SCREWS



60625
SCHRAUBEN-SET
SET OF SCREWS



60626
SCHRAUBEN-SET
SET OF SCREWS



60630
WANNE
TUB



SPARE PARTS



60634
SCHRAUBEN
SCREWS



60635
TEIL B
PART B



60636
TEIL D
PART D



60637
HOLZTEIL
WOODEN PART



60638
HOLZTEIL KLEIN, OBEN
WOODEN PART, SMALL TOP



60639
PUFFER FÜR SCHRAUBEN
PUFFER FOR SCREWS



60640
PUFFER FÜR SCHRAUBEN
PUFFER FOR SCREWS



60641
GRIFFE FÜR RIKSCHA
RICKSHAW HANDLES



60642
RAD MIT BREMSE
WHEEL WITH BRAKE



60643
RAD OHNE BREMSE
WHEEL WITHOUT BRAKE



60702
SITZ, GROSS
SEAT, BIG



60718
TRITTBRETT, DREIRAD „STEP ON“
STEPPING BOARD, STEP ON TRIKE



60729
GUMMIFUSS
RUBBER CAP



60763
VERBINDUNGSSTANGE
CONNECTING ROD



60770
HÜLSE
SLEEVE



60791
LAGER KEGEL- UND KUGELFÖRMIG, 2ER SET
BEARING CONICAL AND SPHERICAL, SET OF 2



60806
ANSCHLAG SCHWARZ
STOPPER BLACK



60808
SITZ
SEAT



60811
STOFF
FABRIC



60850
WASSERHAHN
WATER TAP



60851
BECKEN OHNE ABFLUSS
BASIN WITHOUT DRAINAGE





ERSATZTEILE

60852
HERDKNÖPFE
STOVE KNOBS



60853
RAD
WHEEL



60860
PVC FOLIE
PVC FILM



60861
RÄDER
WHEELS



60862
SCHRAUBEN-SET
SET OF SCREWS



60870
PLASTIKHALTER
PLASTIC HOLDER



60872
BECKEN MIT ABFLUSS
BASIN WITH DRAINAGE



60873
SCHLAUCH MIT SIEB
WATER SLIP TUBE



60874
ABFLUSS
DRAINAGE



60876
TRICHTER MIT SCHLAUCH
FUNNEL WITH TUBE



60877
SCHRAUBEN-SET
SET OF SCREWS



60878
PUMPE
PUMP



68503
ERSATZTEIL „MAGNETSTIFT“
WOODEN MAGNETIC STICK



68504
SCHUTZWANNE
PLASTIC PAN



ERSATZTEILÜBERSICHT – TOPTRIKE





















LIST OF SPARE PARTS – TOPTRIKE



	Art. Nr. item no.	Produkt · Product																					
			60500	60501	60502	60503	60505	60506	60507	60508	60509	60510	60511	60533	60534	60535	60537	60538	60539	60540	60542	60543	60544
64000	Bengy	EVA-Hinterrad, Roller „Bengy“ EVA back wheel, Scooter „Bengy“	•			•				•												•	
64010	Scooter, big	EVA-Rad, vorn/hinten inkl. Halterung EVA wheel, front/back incl. mounting				•				•											•		
64020	Scooter, small	EVA-Hinterrad, Dreiräder EVA back wheel, Trikes				•				•											•		
64030	Little Walker	EVA-Rad vorn/hinten versch. Typen, inkl. Halterung EVA wheel front/back diff. types, incl. mounting		•		•				•		•											
64040	Walker	EVA-Rad, Hinterad „Walker“/Schubkarre EVA wheel, back wheel „Walker“/Wheelbarrow				•	•			•			•										
64050	Small Trike	EVA-Vorderrad, Kleines Dreirad EVA front wheel, Small Trike			•			•		•	•	•											
64060	Rookie	EVA-Vorderrad, Dreiräder EVA front wheel, Trikes			•				•	•	•		•										
64070	Taxi	Griff gelb/schwarz · Handle, yellow/black							•	•	•												
64080	Express Trike	Pedal, gelb/schwarz · Pedal, yellow/black							•	•	•												
64100	Quaddy	Kleiner Sitz, schwarz · Small seat, black										•											
64120	Rider	Langer Sitz, schwarz · Long seat, black											•										
64130	Chopper	Lenkrad, Rutschrad „Quaddy“ Steering wheel, Quaddy							•	•	•												
64140	Pillion Taxi	TPR-Vorderrad, Rutschrad „Quaddy“ TPR front wheel, Quaddy												•	•	•							
64160	Digger	TPR-Hinterad, Rutschrad „Quaddy“ TPR back wheel, Quaddy																					
64170	Side Car	ECO-Griff für Krippenroller, schwarz ECO-handle for Mini Rolly, black															•	•	•	•			
64180	Rickshaw	EVA-Vorderrad, Krippenroller EVA front wheel, Mini Rolly																					
64190	Mini Rolly	EVA-Hinterad, Krippenroller EVA back wheel, Mini Rolly																					
64200	Top Bike	Trittbrett, Krippenroller Stepping board, Mini Rolly																					•
64240	Little Drifter	Trittbrett, Roller Stepping board, Scooter		•	•																		
64270	Speed Star, small	Trittbrett, Roller „Bengy“ Stepping board, Scooter „Bengy“																					
64280	Speed Star, big	EVA-Hinterad „Lernfahrrad „Top Bike“ EVA back wheel, Top Bike																					
64290	Drift Rider								•	•	•												
64300	Little Driver																						
64310	Little Cruiser									•													
64320	Little Balancer									•													
64330	Step'n Roll									•													
64340																							





























ERSATZTEILÜBERSICHT – TOPTRIKE

LIST OF SPARE PARTS – TOPTRIKE

	Art. Nr. item no.	Produkt · Product																					
	60547	Trittbrett, Dreirad „Express“ Stepping board, Express Trike																					
	60548	Trittbrett, Dreirad „Taxi“ Stepping board, Taxi																					
	60549	Sitzbrett, Dreirad „Doppeltaxi“ Seating board, Pillion Taxi																					
	60550	Trittbrett, Dreirad „Doppeltaxi“ Stepping board, Pillion Taxi																					
	60552	Trittbrett, Dreirad „Seitenwagen“ Stepping board, Side Car																					
	60554	EVA-Hinterrad, Dreirad „Rider“ EVA back wheel, Rider																					
	60559	Sitzbrett, Rikschas Seating board, Rickshaw																					
	60560	Trittbrett, Rikschas Stepping board, Rickshaw																					
	60570	Puffer, 4er Set · Set of 4 nylon bush																					
	60573	Lenkhalterung mit Anschlag, 1 Paar · 1 Pair Steering Bearing																					
	60580	Ersatzteilset 1 · Spare part set 1																					
	60581	Ersatzteilset 2 · Spare part set 2																					
	60582	Ersatzteilset 3 · Spare part set 3																					
	60583	Ersatzteilset 4 · Spare part set 4																					
	60584	Ersatzteilset 5 · Spare part set 5																					
	60586	Verbindungsbolzen, kurz Bolt, small																					
	60587	Verbindungsbolzen, lang Bolt, large																					
	60589	Schraubenset · Set of screws																					
	60591	Rad „Speed Star“ · Wheel „Speed Star“																					
	60596	Hinterrad „Drift Rider“ Back wheel „Drift Rider“																					
	60599	Rad einzeln · Wheel																					
	60600	Sitz · Seat																					
64000	Bengy																						
64010	Scooter, big																						
64020	Scooter, small																						
64030	Little Walker																						
64040	Walker																						
64050	Small Trike																						
64060	Rookie																						
64070	Taxi																						
64080	Express Trike																						
64100	Quaddy																						
64120	Rider																						
64130	Chopper																						
64140	Pillion Taxi																						
64160	Digger																						
64170	Side Car																						
64180	Rickshaw																						
64190	Mini Rolly																						
64200	Top Bike																						
64240	Little Drifter																						
64270	Speed Star, small																						
64280	Speed Star, big																						
64290	Drift Rider																						
64300	Little Driver																						
64310	Little Cruiser																						
64320	Little Balancer																						
64330	Step'n Roll																						

ERSATZTEILÜBERSICHT – TOPPLAY

LIST OF SPARE PARTS – TOPPLAY

																																					
Art. Nr. item no.	Produkt · Product	60505	60508	60522	60523	60524	60525	60526	60527	60528	60529	60530	60532	60556	60569	60571	60579	60583	60606	60620	60621	60622	60623	60624	60625												
	EVA-Hinterrad „Walker“ / Schubkarre EVA back wheel																																				
	Griff · Handle																																				
	Wanne Dumper · Dumper bucket																																				
	Kabine Dumper · Driving room																																				
	Radkappe dumper · Wheel mat																																				
	Achsbuchse · Axle cover																																				
	Rad + Radabdeckung · Wheel + wheel cover																																				
	Achse · Axle																																				
	Achskappe · Snap																																				
	Dichtung · Washer																																				
	Schrauben · Screws																																				
	Wanne rot, Schubkarre Tub red, wheelbarrow																																				
	Trittbrett, Balancierscheibe Stepping board Turning Table																																				
	Achskappe rot · Red cap																																				
	Ersatzrad · Wheel																																				
	Gelbe Stange inkl. Kappen Yellow bars inc. caps																																				
	Ersatzteilset 4 · Spare part set 4																																				
	Lenkrad · Steering wheel																																				
	Hinterrad · Rear wheel																																				
	Stoff · Fabric																																				
	Trittbrett · Running board																																				
	Rad · Wheel																																				
	Schrauben Set · Set of screws																																				
	Schrauben Set · Set of screws																																				
62010	Mobiles Gewächshaus · Mobile Greenhouse																																				
62020	Mobiler Wasser-Tisch · Mobile Water-Table																																				
62030	Mobile Küche · Mobile Kitchen																																				
62040	Kiosk 4 in 1																																				
62050	Camping Car																																				
62060	Mobile Tank- & Servicestation · Mobile Gas & Service Station																																				
64090	Schubkarre · Wheelbarrow																																				
64350	Buggy																																				
64360	Karussell · Carousel																																				
64370	Mobile Waage · Mobile Scale																																				
67000	Balancierscheibe · Turning Table																																				
68042	Transportwagen · Transport Cage																																				
68230	Multi-Bänke, 4er Set · Set of 4 Multi benches																																				
66010	Dumper																																				
66000	Blauer Truck																																				

FOLLOW US...



LIKE US ON FACEBOOK!
@BELEDUC.LERNSPIELWAREN



LIKE US ON INSTAGRAM!
@BELEDUC_LERNSPIELWAREN , @BELEDUC_EUROPE



GAME VIDEOS ON YOUTUBE!
YOUTUBE.COM/PLAYEXPERIENCELEARN



MORE INFORMATION UNDER:
WWW.BELEDUC.DE



**DIREKT AUF UNSERE
SOCIAL MEDIA SEITEN
GEHEN UND LIKEN!**

**GO DIRECTLY TO
OUR SOCIAL MEDIA
PAGE AND LIKE!**













Bildungsbereiche | Educational Areas

-  Künstlerische Bildung
Art Education
-  Somatische Bildung
Somatic Education
-  Soziale Bildung
Social Education
-  Mathematische Bildung
Mathematics Education
-  Sprachliche Bildung
Linguistic Education
-  Naturwissenschaftliche Bildung
Science Education
-  Primärer Bildungsbereich
Primary Area of Education

**Förderbereiche Small Kids
Basic Skills Small Kids**

-  Balance
Balance
-  Taktil
Tactile
-  Visuell
Visual
-  Kognitiv
Cognitive
-  Auditiv
Auditory

Produktinfo | Product Information

-  **Achtung!** Nicht für Kinder unter 3 Jahren geeignet. Kleine Teile. Erstickungsgefahr.
Warning! Not suitable for children under 3 years. Small parts. Choking hazard.
-  **Achtung!** Nicht für Kinder unter 3 Jahren geeignet. Lange Schnur. Strangulierungsgefahr.
Warning! Not suitable for children under 3 years. Long string. Strangulation hazard.
-  **Achtung!** Nicht für Kinder unter 18 Monaten geeignet. Lange Schnur/Lange Kette. Strangulationsgefahr.
Warning! Not suitable for children under 18 months. Long string/chain. Strangulation hazard.
-  **Achtung!** Für Kinder unter 3 Jahren nicht geeignet. Enthält ablösbare Kleinteile.
Warning! Not suitable for children under 3 years. Contains removable little pieces.
-  Mit diesem Symbol gekennzeichnete Produkte sind direkt von unserem Lager in China verfügbar.
Products marked with this sign can be shipped from our China warehouse.
-   Altersempfehlung*
Age recommendation*
-   Anzahl der Teile
Number of parts
-  Spieleranzahl
Number of players
-  5 Jahre Garantie
5 Years Warranty

China

European EducationAll Group
9-27 Nanhai Road
315800 Ningbo, Beilun, China
T: +86 574 8698 7153
F: +86 574 8686 9257
sales@educationall.com
www.educationall.com

Asia/Pacific

European EducationAll Group
9-27 Nanhai Road
315800 Ningbo, Beilun, China
T: +86 574 8685 7555
F: +86 574 8685 7551
welcome@educationall.com
www.educationall.com

***Altersempfehlung**

Hinweise zur Altersangabe im Katalog: Die Kennzeichnung ist als eine Altersempfehlung zu sehen. Die Produkte sind aus pädagogischer Sicht ab dem gekennzeichneten Alter ideal geeignet. Alle unsere Produkte sind ab einem Alter von 3+ getestet und erfüllen internationale Teststandards. Unsere Produkte der Small Kids Linie sowie einzelne Fahrzeuge der Linie TopTrike, sind entsprechend unserer Altersangabe für Kinder unter 3 Jahren getestet und geeignet.

***Age recommendation**

Notes on the age specification in the catalogue: The labelling is to be seen as an age recommendation. From an educational point of view, the products are ideally suitable from the marked age. All our products are tested from an age of 3+ and meet international testing standards. Our products in the Small Kids line, as well as individual vehicles in the TopTrike line, are tested and suitable for children under 3 years of age according to our age statement.

HINWEIS | NOTE

Die Größenangaben beziehen sich auf die Produktgröße bzw. bei den Spielen auf die Boxgröße. Farb- und technische Änderungen vorbehalten. Bei den Spielen bezieht sich die Angabe zur Anzahl der Teile auf alle im Spiel enthaltenen, bei Puzzles auf alle herausnehmbaren Teile. Alle mit Altersangabe versehenen Artikel sind Spielzeug und bei Artikeln ohne Altersangabe handelt es sich ausdrücklich nicht um Spielzeug im Sinne der Spielzeugrichtlinie 2009/48/EG.

The sizes mentioned in the catalogue refer to the size of the product or for games to the size of the box. Technical changes and changes in colour reserved. The information on the number of parts refers to all parts or pieces that the game contains. For puzzles, the information on the number of parts refers to the removable parts only. All items marked with an age informaton are classified as toys and all items without an age informaton are not classified as toys according to the Toys Safety Directive 2009/48/EC.

Y · EXPERIENCE · LEARN · PL
XPERIENCE · LEARN · PLAY ·
ERIENCE · LEARN · PLAY · EX
IENCE · LEARN · PLAY · EX
N · PL
LAY
Y · EX
N · PL
LAY ·
Y · EXPE



 LIKE US ON FACEBOOK!
[@BELEDUC.LERNSPIELWAREN](https://www.facebook.com/beleduc.lernspielwaren)

 LIKE US ON INSTAGRAM!
[@BELEDUC_LERNSPIELWAREN](https://www.instagram.com/beleduc_lernspielwaren) , [@BELEDUC_EUROPE](https://www.instagram.com/beleduc_europe)

 GAME VIDEOS ON YOUTUBE!
[YOUTUBE.COM/PLAYEXPERIENCELEARN](https://www.youtube.com/channel/UC-LEARN-PLAY-EXPERIENCE)

 MORE INFORMATION UNDER:
WWW.BELEDUC.DE

PLAY · EXPERIENCE · LEARN ·

beleduc Lernspielwaren GmbH
Heinrich-Heine-Weg 2
09526 Olbernhau
Germany

T: +49 37360 162 0
F: +49 37360 162 29
info@beleduc.de
www.beleduc.de

